



CYPRESS

CY7C1360B
CY7C1362B

9-Mbit (256K x 36/512K x 18) Pipelined SRAM

Features

- Supports bus operation up to 225 MHz
- Available speed grades are 225, 200 and 166 MHz
- Registered inputs and outputs for pipelined operation
- 3.3V core power supply
- 2.5V/3.3V I/O operation
- Fast clock-to-output times
 - 2.8 ns (for 225-MHz device)
 - 3.0 ns (for 200-MHz device)
 - 3.5 ns (for 166-MHz device)
- Provide high-performance 3-1-1-1 access rate
- User-selectable burst counter supporting Intel® Pentium® interleaved or linear burst sequences
- Separate processor and controller address strobes
- Synchronous self-timed writes
- Asynchronous output enable
- Single Cycle Chip Deselect
- Offered in JEDEC-standard 100-pin TQFP, 119-ball BGA and 165-Ball fBGA packages
- TQFP Available with 3-Chip Enable and 2-Chip Enable
- IEEE 1149.1 JTAG-Compatible Boundary Scan
- “ZZ” Sleep Mode Option

Functional Description^[1]

The CY7C1360B/CY7C1362B SRAM integrates 262,144 x 36 and 524,288 x 18 SRAM cells with advanced synchronous peripheral circuitry and a two-bit counter for internal burst operation. All synchronous inputs are gated by registers controlled by a positive-edge-triggered Clock Input (CLK). The synchronous inputs include all addresses, all data inputs, address-pipelining Chip Enable (\overline{CE}_1), depth-expansion Chip Enables (CE_2 and \overline{CE}_3 ^[2]), Burst Control inputs (\overline{ADSC} , \overline{ADSP} , and \overline{ADV}), Write Enables (\overline{BW}_Y , and \overline{BWE}), and Global Write (\overline{GW}). Asynchronous inputs include the Output Enable (\overline{OE}) and the ZZ pin.

Addresses and chip enables are registered at rising edge of clock when either Address Strobe Processor (\overline{ADSP}) or Address Strobe Controller (\overline{ADSC}) are active. Subsequent burst addresses can be internally generated as controlled by the Advance pin (ADV).

Address, data inputs, and write controls are registered on-chip to initiate a self-timed Write cycle. This part supports Byte Write operations (see Pin Descriptions and Truth Table for further details). Write cycles can be one to two or four bytes wide as controlled by the Byte Write control inputs. \overline{GW} when active LOW causes all bytes to be written.

The CY7C1360B/CY7C1362B operates from a +3.3V core power supply while all outputs may operate with either a +2.5 or +3.3V supply. All inputs and outputs are JEDEC-standard JESD8-5-compatible.

Selection Guide

	225 MHz	200 MHz	166 MHz	Unit
Maximum Access Time	2.8	3.0	3.5	ns
Maximum Operating Current	250	220	180	mA
Maximum CMOS Standby Current	30	30	30	mA

Shaded areas contain advance information. Please contact your local Cypress sales representative for availability of these parts.

Notes:

1. For best-practices recommendations, please refer to the Cypress application note *System Design Guidelines* on www.cypress.com.
2. \overline{CE}_3 is for A version of TQFP (3 Chip Enable option) and 165 fBGA package only. 119 BGA is offered only in 2 Chip Enable.

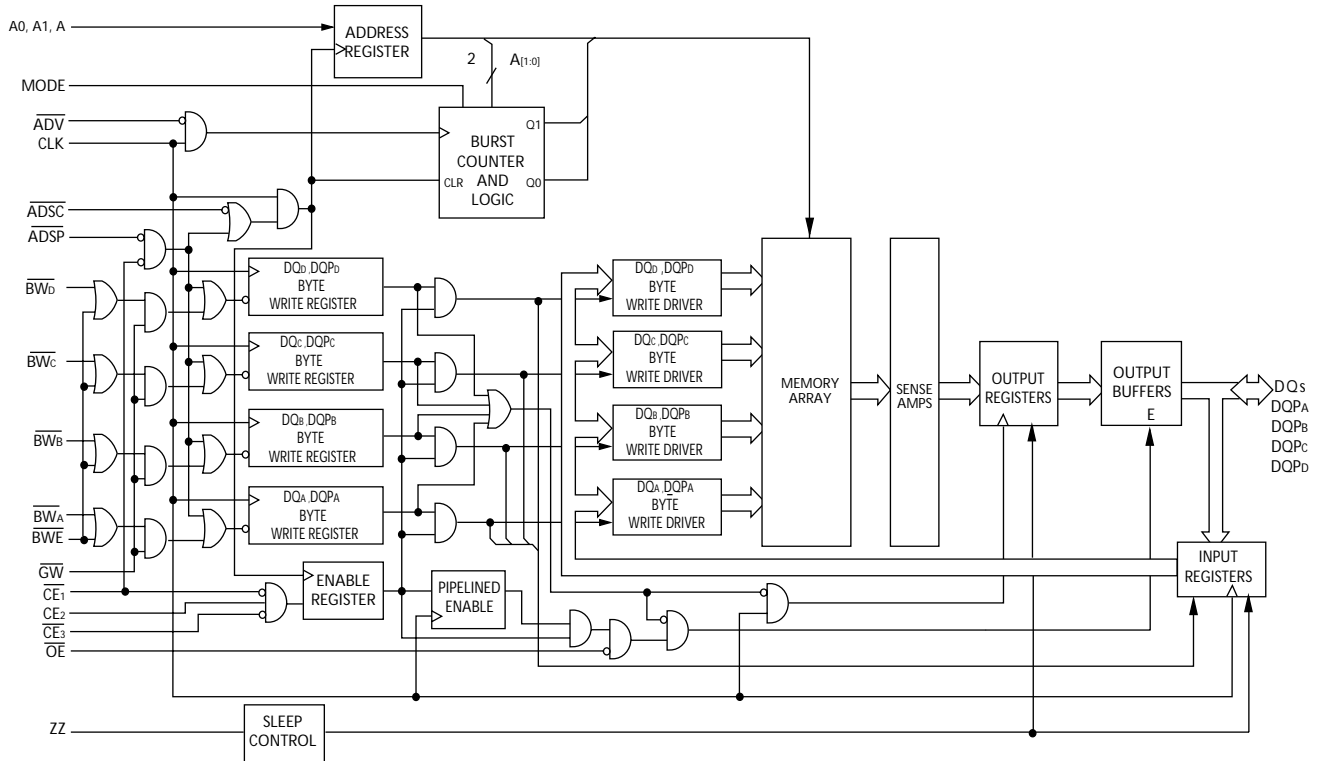
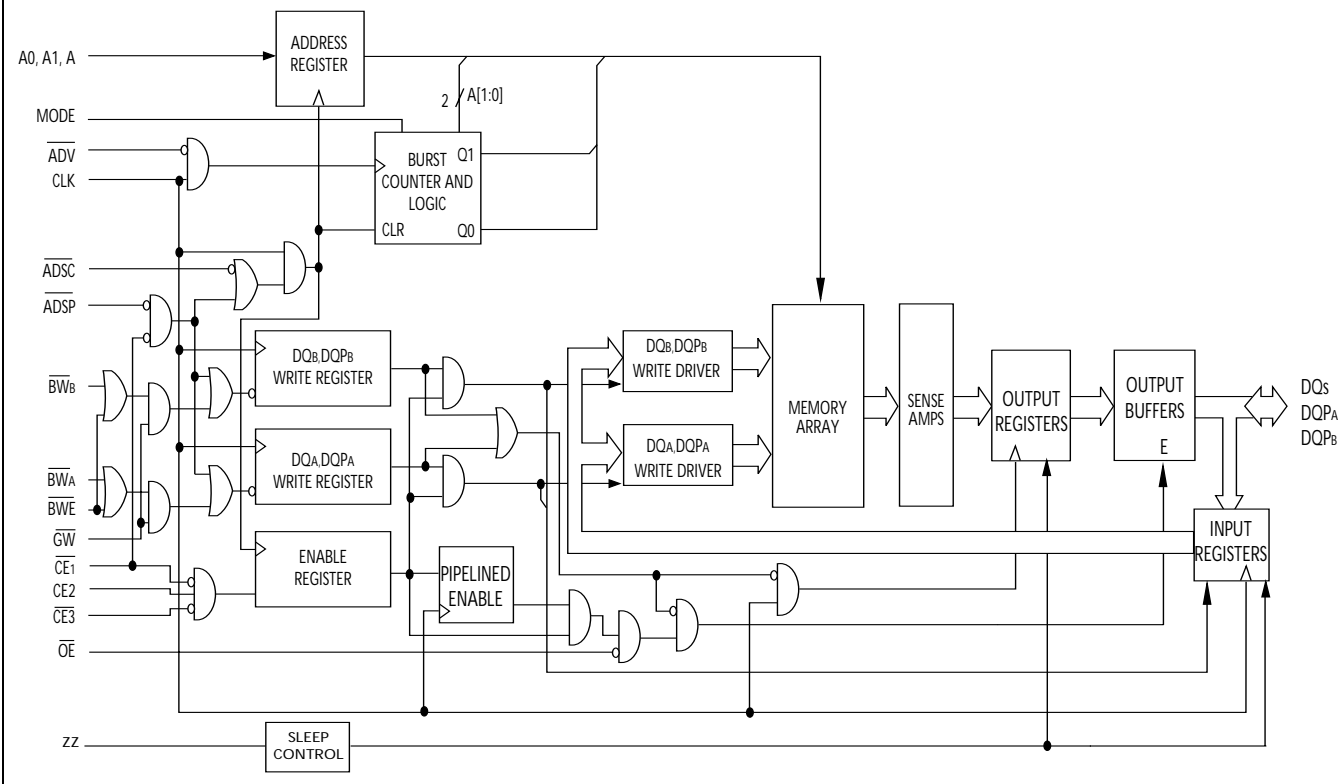
Logic Block Diagram CY7C1360B (256K x 36)

Logic Block Diagram – CY7C1362B (512K x 18)

Pin Configurations (continued)

119-ball BGA (2 Chip Enables with JTAG)
CY7C1360B (256K x 36)

	1	2	3	4	5	6	7
A	V _{DDQ}	A	A	$\overline{\text{ADSP}}$	A	A	V _{DDQ}
B	NC	CE ₂	A	$\overline{\text{ADSC}}$	A	A	NC
C	NC	A	A	V _{DD}	A	A	NC
D	DQ _C	DQP _C	V _{SS}	NC	V _{SS}	DQP _B	DQ _B
E	DQ _C	DQ _C	V _{SS}	$\overline{\text{CE}}_1$	V _{SS}	DQ _B	DQ _B
F	V _{DDQ}	DQ _C	V _{SS}	$\overline{\text{OE}}$	V _{SS}	DQ _B	V _{DDQ}
G	DQ _C	DQ _C	$\overline{\text{BW}}_C$	$\overline{\text{ADV}}$	$\overline{\text{BW}}_B$	DQ _B	DQ _B
H	DQ _C	DQ _C	V _{SS}	$\overline{\text{GW}}$	V _{SS}	DQ _B	DQ _B
J	V _{DDQ}	V _{DD}	NC	V _{DD}	NC	V _{DD}	V _{DDQ}
K	DQ _D	DQ _D	V _{SS}	CLK	V _{SS}	DQ _A	DQ _A
L	DQ _D	DQ _D	$\overline{\text{BW}}_D$	NC	$\overline{\text{BW}}_A$	DQ _A	DQ _A
M	V _{DDQ}	DQ _D	V _{SS}	$\overline{\text{BWE}}$	V _{SS}	DQ _A	V _{DDQ}
N	DQ _D	DQ _D	V _{SS}	A1	V _{SS}	DQ _A	DQ _A
P	DQ _D	DQP _D	V _{SS}	A0	V _{SS}	DQP _A	DQ _A
R	NC	A	MODE	V _{DD}	NC	A	NC
T	NC	NC	A	A	A	NC	ZZ
U	V _{DDQ}	TMS	TDI	TCK	TDO	NC	V _{DDQ}

CY7C1362B (512K x 18)

	1	2	3	4	5	6	7
A	V _{DDQ}	A	A	$\overline{\text{ADSP}}$	A	A	V _{DDQ}
B	NC	CE ₂	A	$\overline{\text{ADSC}}$	A	A	NC
C	NC	A	A	V _{DD}	A	A	NC
D	DQ _B	NC	V _{SS}	NC	V _{SS}	DQP _A	NC
E	NC	DQ _B	V _{SS}	$\overline{\text{CE}}_1$	V _{SS}	NC	DQ _A
F	V _{DDQ}	NC	V _{SS}	$\overline{\text{OE}}$	V _{SS}	DQ _A	V _{DDQ}
G	NC	DQ _B	$\overline{\text{BW}}_B$	$\overline{\text{ADV}}$	V _{SS}	NC	DQ _A
H	DQ _B	NC	V _{SS}	$\overline{\text{GW}}$	V _{SS}	DQ _A	NC
J	V _{DDQ}	V _{DD}	NC	V _{DD}	NC	V _{DD}	V _{DDQ}
K	NC	DQ _B	V _{SS}	CLK	V _{SS}	NC	DQ _A
L	DQ _B	NC	V _{SS}	NC	$\overline{\text{BW}}_A$	DQ _A	NC
M	V _{DDQ}	DQ _B	V _{SS}	$\overline{\text{BWE}}$	V _{SS}	NC	V _{DDQ}
N	DQ _B	NC	V _{SS}	A1	V _{SS}	DQ _A	NC
P	NC	DQP _B	V _{SS}	A0	V _{SS}	NC	DQ _A
R	NC	A	MODE	V _{DD}	NC	A	NC
T	NC	A	A	NC	A	A	ZZ
U	V _{DDQ}	TMS	TDI	TCK	TDO	NC	V _{DDQ}

Pin Configurations (continued)

165-ball fBGA (3 Chip Enable with JTAG)
CY7C1360B (256K x 36)

	1	2	3	4	5	6	7	8	9	10	11
A	NC / 288M	A	\overline{CE}_1	\overline{BW}_C	\overline{BW}_B	\overline{CE}_3	\overline{BWE}	\overline{ADSC}	\overline{ADV}	A	NC
B	NC	A	CE2	\overline{BW}_D	\overline{BW}_A	CLK	\overline{GW}	\overline{OE}	\overline{ADSP}	A	NC / 144M
C	DQP _C	NC	V _{DDQ}	V _{SS}	V _{SS}	V _{SS}	V _{SS}	V _{SS}	V _{DDQ}	NC	DQP _B
D	DQ _C	DQ _C	V _{DDQ}	V _{DD}	V _{SS}	V _{SS}	V _{SS}	V _{DD}	V _{DDQ}	DQ _B	DQ _B
E	DQ _C	DQ _C	V _{DDQ}	V _{DD}	V _{SS}	V _{SS}	V _{SS}	V _{DD}	V _{DDQ}	DQ _B	DQ _B
F	DQ _C	DQ _C	V _{DDQ}	V _{DD}	V _{SS}	V _{SS}	V _{SS}	V _{DD}	V _{DDQ}	DQ _B	DQ _B
G	DQ _C	DQ _C	V _{DDQ}	V _{DD}	V _{SS}	V _{SS}	V _{SS}	V _{DD}	V _{DDQ}	DQ _B	DQ _B
H	NC	V _{SS}	NC	V _{DD}	V _{SS}	V _{SS}	V _{SS}	V _{DD}	NC	NC	ZZ
J	DQ _D	DQ _D	V _{DDQ}	V _{DD}	V _{SS}	V _{SS}	V _{SS}	V _{DD}	V _{DDQ}	DQ _A	DQ _A
K	DQ _D	DQ _D	V _{DDQ}	V _{DD}	V _{SS}	V _{SS}	V _{SS}	V _{DD}	V _{DDQ}	DQ _A	DQ _A
L	DQ _D	DQ _D	V _{DDQ}	V _{DD}	V _{SS}	V _{SS}	V _{SS}	V _{DD}	V _{DDQ}	DQ _A	DQ _A
M	DQ _D	DQ _D	V _{DDQ}	V _{DD}	V _{SS}	V _{SS}	V _{SS}	V _{DD}	V _{DDQ}	DQ _A	DQ _A
N	DQP _D	NC	V _{DDQ}	V _{SS}	NC	NC / 18M	NC	V _{SS}	V _{DDQ}	NC	DQP _A
P	NC	NC / 72M	A	A	TDI	A1	TDO	A	A	A	A
R	MODE	NC / 36M	A	A	TMS	A0	TCK	A	A	A	A

CY7C1362B (512K x 18)

	1	2	3	4	5	6	7	8	9	10	11
A	NC / 288M	A	\overline{CE}_1	\overline{BW}_B	NC	\overline{CE}_3	\overline{BWE}	\overline{ADSC}	\overline{ADV}	A	A
B	NC	A	CE2	NC	\overline{BW}_A	CLK	\overline{GW}	\overline{OE}	\overline{ADSP}	A	NC / 144M
C	NC	NC	V _{DDQ}	V _{SS}	V _{SS}	V _{SS}	V _{SS}	V _{SS}	V _{DDQ}	NC	DQP _A
D	NC	DQ _B	V _{DDQ}	V _{DD}	V _{SS}	V _{SS}	V _{SS}	V _{DD}	V _{DDQ}	NC	DQ _A
E	NC	DQ _B	V _{DDQ}	V _{DD}	V _{SS}	V _{SS}	V _{SS}	V _{DD}	V _{DDQ}	NC	DQ _A
F	NC	DQ _B	V _{DDQ}	V _{DD}	V _{SS}	V _{SS}	V _{SS}	V _{DD}	V _{DDQ}	NC	DQ _A
G	NC	DQ _B	V _{DDQ}	V _{DD}	V _{SS}	V _{SS}	V _{SS}	V _{DD}	V _{DDQ}	NC	DQ _A
H	NC	V _{SS}	NC	V _{DD}	V _{SS}	V _{SS}	V _{SS}	V _{DD}	NC	NC	ZZ
J	DQ _B	NC	V _{DDQ}	V _{DD}	V _{SS}	V _{SS}	V _{SS}	V _{DD}	V _{DDQ}	DQ _A	NC
K	DQ _B	NC	V _{DDQ}	V _{DD}	V _{SS}	V _{SS}	V _{SS}	V _{DD}	V _{DDQ}	DQ _A	NC
L	DQ _B	NC	V _{DDQ}	V _{DD}	V _{SS}	V _{SS}	V _{SS}	V _{DD}	V _{DDQ}	DQ _A	NC
M	DQ _B	NC	V _{DDQ}	V _{DD}	V _{SS}	V _{SS}	V _{SS}	V _{DD}	V _{DDQ}	DQ _A	NC
N	DQP _B	NC	V _{DDQ}	V _{SS}	NC	NC / 18M	NC	V _{SS}	V _{DDQ}	NC	NC
P	NC	NC / 72M	A	A	TDI	A1	TDO	A	A	A	A
R	MODE	NC / 36M	A	A	TMS	A0	TCK	A	A	A	A

CY7C1360B–Pin Definitions

Name	TQFP 3-Chip Enable	TQFP 2-Chip Enable	BGA	fBGA	I/O	Description
A ₀ , A ₁ , A	37,36,32,33,34,35,43,44,45,46,47,48,49,50,81,82,99,100	37,36,32,33,34,35,44,45,46,47,48,49,50,81,82,92,99,100	P4,N4,A2,C2,R2,3A,B3,C3,T3,T4,A5,B5,C5,T5,A6,B6,C6,R6	R6,P6,A2,A10,B2,B10,P3,P4,P8,P9,P10,P11,R3,R4,R8,R9,R10,R11	Input-Synchronous	Address Inputs used to select one of the 256K address locations. Sampled at the rising edge of the CLK if \overline{ADSP} or \overline{ADSC} is active LOW, and CE ₁ , CE ₂ , and CE ₃ ^[2] are sampled active. A ₁ , A ₀ are fed to the two-bit counter.
$\overline{BW_A}$, $\overline{BW_B}$ $\overline{BW_C}$, $\overline{BW_D}$	93,94,95,96	93,94,95,96	L5,G5,G3,L3	B5,A5,A4,B4	Input-Synchronous	Byte Write Select Inputs, active LOW. Qualified with BWE to conduct Byte Writes to the SRAM. Sampled on the rising edge of CLK.
\overline{GW}	88	88	H4	B7	Input-Synchronous	Global Write Enable Input, active LOW. When asserted LOW on the rising edge of CLK, a global Write is conducted (ALL bytes are written, regardless of the values on $\overline{BW_x}$ and BWE).
\overline{BWE}	87	87	M4	A7	Input-Synchronous	Byte Write Enable Input, active LOW. Sampled on the rising edge of CLK. This signal must be asserted LOW to conduct a Byte Write.
CLK	89	89	K4	B6	Input-Clock	Clock Input. Used to capture all synchronous inputs to the device. Also used to increment the burst counter when ADV is asserted LOW, during a burst operation.
$\overline{CE_1}$	98	98	E4	A3	Input-Synchronous	Chip Enable 1 Input, active LOW. Sampled on the rising edge of CLK. Used in conjunction with $\overline{CE_2}$ and CE ₃ ^[2] to select/deselect the device. ADSP is ignored if $\overline{CE_1}$ is HIGH.
CE ₂	97	97	B2	B3	Input-Synchronous	Chip Enable 2 Input, active HIGH. Sampled on the rising edge of CLK. Used in conjunction with $\overline{CE_1}$ and CE ₃ ^[2] to select/deselect the device.
$\overline{CE_3}$ ^[2]	92	-	-	A6	Input-Synchronous	Chip Enable 3 Input, active LOW. Sampled on the rising edge of CLK. Used in conjunction with $\overline{CE_1}$ and CE ₂ to select/deselect the device. Not available for AJ package version. Not connected for BGA. Where referenced, CE ₃ ^[2] is assumed active throughout this document for BGA.
\overline{OE}	86	86	F4	B8	Input-Asynchronous	Output Enable, asynchronous input, active LOW. Controls the direction of the I/O pins. When LOW, the I/O pins behave as outputs. When deasserted HIGH, I/O pins are three-stated, and act as input data pins. OE is masked during the first clock of a read cycle when emerging from a deselected state.
\overline{ADV}	83	83	G4	A9	Input-Synchronous	Advance Input signal, sampled on the rising edge of CLK, active LOW. When asserted, it automatically increments the address in a burst cycle.

CY7C1360B–Pin Definitions (continued)

Name	TQFP 3-Chip Enable	TQFP 2-Chip Enable	BGA	fBGA	I/O	Description
$\overline{\text{ADSP}}$	84	84	A4	B9	Input-Synchronous	Address Strobe from Processor, sampled on the rising edge of CLK, active LOW. When asserted LOW, addresses presented to the device are captured in the address registers. A_1, A_0 are also loaded into the burst counter. When ADSP and ADSC are both asserted, only ADSP is recognized. ADSP is ignored when $\overline{\text{CE}}_1$ is deasserted HIGH.
$\overline{\text{ADSC}}$	85	85	B4	A8	Input-Synchronous	Address Strobe from Controller, sampled on the rising edge of CLK, active LOW. When asserted LOW, addresses presented to the device are captured in the address registers. A_1, A_0 are also loaded into the burst counter. When ADSP and ADSC are both asserted, only ADSP is recognized.
ZZ	64	64	T7	H11	Input-Asynchronous	ZZ “Sleep” Input, active HIGH. When asserted HIGH places the device in a non-time-critical “sleep” condition with data integrity preserved. For normal operation, this pin has to be LOW or left floating. ZZ pin has an internal pull-down.
DQs, DQP _s	52,53,56,57,58,59,62,63,68,69,72,73,74,75,78,79,2,3,6,7,8,9,12,13,18,19,22,23,24,25,28,29,51,80,1,30	52,53,56,57,58,59,62,63,68,69,72,73,74,75,78,79,2,3,6,7,8,9,12,13,18,19,22,23,24,25,28,29,51,80,1,30	K6,L6,M6,N6,K7,L7,N7,P7,E6,F6,G6,H6,D7,E7,G7,H7,D1,E1,G1,H1,E2,F2,G2,H2,K1,L1,N1,P1,K2,L2,M2,N2,P6,D6,D2,P2	M11,L11,K11,J11,J10,K10,L10,M10,D10,E10,F10,G10,D11,E11,F11,G11,D1,E1,F1,G1,D2,E2,F2,G2,J1,K1,L1,M1,J2,K2,L2,M2,N11,C11,C1,N1	I/O-Synchronous	Bidirectional Data I/O lines. As inputs, they feed into an on-chip data register that is triggered by the rising edge of CLK. As outputs, they deliver the data contained in the memory location specified by the addresses presented during the previous clock rise of the read cycle. The direction of the pins is controlled by OE. When OE is asserted LOW, the pins behave as outputs. When HIGH, DQs and DQP _x are placed in a three-state condition.
V _{DD}	15,41,65,91	15,41,65,91	J2,C4,J4,R4,J6	D4,D8,E4,E8,F4,F8,G4,G8,H4,H8,J4,J8,K4,K8,L4,L8,M4,M8	Power Supply	Power supply inputs to the core of the device.
V _{SS}	17,40,67,90	17,40,67,90	D3,E3,F3,H3,K3,M3,N3,P3,D5,E5,F5,H5,K5,M5,N5,P5	C4,C5,C6,C7,C8,D5,D6,D7,E5,E6,E7,F5,F6,F7,G5,G6,G7,H2,H5,H6,H7,J5,J6,J7,K5,K6,K7,L5,L6,L7,M5,M6,M7,N4,N8	Ground	Ground for the core of the device.

CY7C1360B–Pin Definitions (continued)

Name	TQFP 3-Chip Enable	TQFP 2-Chip Enable	BGA	fBGA	I/O	Description
V _{SSQ}	5,10,21,26, 55,60,71, 76	5,10,21,26, 55,60,71, 76	-	-	I/O Ground	Ground for the I/O circuitry.
V _{DDQ}	4,11,20,27, 54,61,70, 77	4,11,20,27, 54,61,70, 77	A1,F1,J1, M1,U1, A7,F7,J7, M7,U7	C3,C9,D3, D9,E3,E9,F 3,F9,G3, G9,J3,J9, K3,K9,L3, L9,M3,M9, N3,N9	I/O Power Supply	Power supply for the I/O circuitry.
MODE	31	31	R3	R1	Input-Static	Selects Burst Order. When tied to GND selects linear burst sequence. When tied to V _{DD} or left floating selects interleaved burst sequence. This is a strap pin and should remain static during device operation. Mode pin has an internal pull-up.
TDO	-	-	U5	P7	JTAG serial output Synchronous	Serial data-out to the JTAG circuit. Delivers data on the negative edge of TCK. If the JTAG feature is not being utilized, this pin should be disconnected. This pin is not available on TQFP packages.
TDI	-	-	U3	P5	JTAG serial input Synchronous	Serial data-In to the JTAG circuit. Sampled on the rising edge of TCK. If the JTAG feature is not being utilized, this pin can be disconnected or connected to V _{DD} . This pin is not available on TQFP packages.
TMS	-	-	U2	R5	JTAG serial input Synchronous	Serial data-In to the JTAG circuit. Sampled on the rising edge of TCK. If the JTAG feature is not being utilized, this pin can be disconnected or connected to V _{DD} . This pin is not available on TQFP packages.
TCK	-	-	U4	R7	JTAG-Clock	Clock input to the JTAG circuitry. If the JTAG feature is not being utilized, this pin must be connected to V _{SS} . This pin is not available on TQFP packages.
NC	14,16,66, 42,39,38	14,16,38, 39,42,43, 66,	B1,C1, R1,T1,T2, J3,D4, L4,5J,5R, 6T,6U, B7,C7, R7	A11,B1,C2, C10,H1,H3, H9,H10, N2,N5,N7, N10,P1,A1, B11,P2,R2, N6	-	No Connects. Not internally connected to the die

CY7C1362B–Pin Definitions

Name	TQFP 3-Chip Enable	TQFP 2-Chip Enable	BGA	fBGA	I/O	Description
A ₀ , A ₁ , A	37,36,32, 33,34,35, 43,44,45, 46,47,48, 49,50,80, 81,82,99, 100	37,36,32, 33,34,35, 44,45,46, 47,48,49, 50,80,81, 82,92,99, 100	P4,N4, A2,C2, R2,T2, A3,B3, C3,T3, A5,B5, C5,T5, A6,B6, C6,R6, T6	R6,P6,A2, A10,A11, B2,B10,P3, P4,P8,P9, P10,P11, R3,R4,R8, R9,R10, R11	Input-Synchronous	Address Inputs used to select one of the 512K address locations. Sampled at the rising edge of the CLK if \overline{ADSP} or \overline{ADSC} is active LOW, and \overline{CE}_1 , \overline{CE}_2 , and $\overline{CE}_3^{[2]}$ are sampled active. A ₁ , A ₀ are fed to the two-bit counter.
\overline{BW}_A , \overline{BW}_B	93,94	93,94	G3,L5	B5,A4	Input-Synchronous	Byte Write Select Inputs, active LOW. Qualified with BWE to conduct Byte Writes to the SRAM. Sampled on the rising edge of CLK.
\overline{GW}	88	88	H4	B7	Input-Synchronous	Global Write Enable Input, active LOW. When asserted LOW on the rising edge of CLK, a global Write is conducted (ALL bytes are written, regardless of the values on \overline{BW}_X and \overline{BWE}).
\overline{BWE}	87	87	M4	A7	Input-Synchronous	Byte Write Enable Input, active LOW. Sampled on the rising edge of CLK. This signal must be asserted LOW to conduct a Byte Write.
CLK	89	89	K4	B6	Input-Clock	Clock Input. Used to capture all synchronous inputs to the device. Also used to increment the burst counter when \overline{ADV} is asserted LOW, during a burst operation.
\overline{CE}_1	98	98	E4	A3	Input-Synchronous	Chip Enable 1 Input, active LOW. Sampled on the rising edge of CLK. Used in conjunction with \overline{CE}_2 and $\overline{CE}_3^{[2]}$ to select/deselect the device. \overline{ADSP} is ignored if \overline{CE}_1 is HIGH.
\overline{CE}_2	97	97	B2	B3	Input-Synchronous	Chip Enable 2 Input, active HIGH. Sampled on the rising edge of CLK. Used in conjunction with \overline{CE}_1 and $\overline{CE}_3^{[2]}$ to select/deselect the device.
$\overline{CE}_3^{[2]}$	92	-	-	A6	Input-Synchronous	Chip Enable 3 Input, active LOW. Sampled on the rising edge of CLK. Used in conjunction with \overline{CE}_1 and \overline{CE}_2 to select/deselect the device. Not available for AJ package version. Not connected for BGA. Where referenced, $\overline{CE}_3^{[2]}$ is assumed active throughout this document for BGA.
\overline{OE}	86	86	F4	B8	Input-Asynchronous	Output Enable, asynchronous input, active LOW. Controls the direction of the I/O pins. When LOW, the I/O pins behave as outputs. When deasserted HIGH, I/O pins are three-stated, and act as input data pins. \overline{OE} is masked during the first clock of a Read cycle when emerging from a deselected state.
\overline{ADV}	83	83	G4	A9	Input-Synchronous	Advance Input signal, sampled on the rising edge of CLK, active LOW. When asserted, it automatically increments the address in a burst cycle.

CY7C1362B–Pin Definitions (continued)

Name	TQFP 3-Chip Enable	TQFP 2-Chip Enable	BGA	fBGA	I/O	Description
$\overline{\text{ADSP}}$	84	84	A4	B9	Input-Synchronous	Address Strobe from Processor, sampled on the rising edge of CLK, active LOW. When asserted LOW, addresses presented to the device are captured in the address registers. A_1, A_0 are also loaded into the burst counter. When ADSP and ADSC are both asserted, only ADSP is recognized. $\overline{\text{ADSP}}$ is ignored when $\overline{\text{CE}}_1$ is deasserted HIGH.
$\overline{\text{ADSC}}$	85	85	P4	A8	Input-Synchronous	Address Strobe from Controller, sampled on the rising edge of CLK, active LOW. When asserted LOW, addresses presented to the device are captured in the address registers. A_1, A_0 are also loaded into the burst counter. When ADSP and ADSC are both asserted, only ADSP is recognized.
ZZ	64	64	T7	H11	Input-Asynchronous	ZZ “Sleep” Input, active HIGH. When asserted HIGH places the device in a non-time-critical “sleep” condition with data integrity preserved. For normal operation, this pin has to be LOW or left floating. ZZ pin has an internal pull-down.
DQs, DQPs	58,59,62,63,68,69,72,73,8,9,12,13,18,19,22,23,74,24	58,59,62,63,68,69,72,73,8,9,12,13,18,19,22,23,74,24	P7,K7,G7,E7,F6,H6,L6,N6,D1,H1,L1,N1,E2,G2,K2,M2,D6,P2	J10,K10,L10,M10,D11,E11,F11,G11,J1,K1,L1,M1,D2,E2,F2,G2,C11,N1	I/O-Synchronous	Bidirectional Data I/O lines. As inputs, they feed into an on-chip data register that is triggered by the rising edge of CLK. As outputs, they deliver the data contained in the memory location specified by the addresses presented during the previous clock rise of the a Read cycle. The direction of the pins is controlled by $\overline{\text{OE}}$. When $\overline{\text{OE}}$ is asserted LOW, the pins behave as outputs. When HIGH, DQs and DQP _x are placed in a three-state condition.
V_{DD}	15,41,65,91	15,41,65,91	C4,J2,J4,J6,R4	D4,D8,E4,E8,F4,F8,G4,G8,H4,H8,J4,J8,K4,K8,L4,L8,M4,M8	Power Supply	Power supply inputs to the core of the device.
V_{SS}	17,40,67,90	17,40,67,90	D3,D5,E5,E3,F3,F5,G5,H3,H5,K3,K5,L3,M3,M5,N3,N5,P3,P5	H2,C4,C5,C6,C7,C8,D5,D6,D7,E5,E6,E7,F5,F6,F7,G5,G6,G7,H5,H6,H7,J5,J6,J7,K5,K6,K7,L5,L6,L7,M5,M6,M7,N4,N8	Ground	Ground for the core of the device.
V_{SSQ}	5,10,21,26,55,60,71,76	5,10,21,26,55,60,71,76	-	-	I/O Ground	Ground for the I/O circuitry.

CY7C1362B–Pin Definitions (continued)

Name	TQFP 3-Chip Enable	TQFP 2-Chip Enable	BGA	fBGA	I/O	Description
V _{DDQ}	4,11,20,27, 54,61,70, 77	4,11,20,27, 54,61,70, 77	A1,A7,F1, F7,J1,J7, M1,M7, U1,U7	C3,C9,D3, D9,E3,E9, F3,F9,G3, G9,J3,J9, K3,K9,L3, L9,M3,M9, N3,N9	I/O Power Supply	Power supply for the I/O circuitry.
MODE	31	31	R3	R1	Input- Static	Selects Burst Order. When tied to GND selects linear burst sequence. When tied to V _{DD} or left floating selects interleaved burst sequence. This is a strap pin and should remain static during device operation. Mode pin has an internal pull-up.
TDO	-	-	U5	P7	JTAG serial output Synchronous	Serial data-out to the JTAG circuit. Delivers data on the negative edge of TCK. If the JTAG feature is not being utilized, this pin should be left unconnected. This pin is not available on TQFP packages.
TDI	-	-	U3	P5	JTAG serial input Synchronous	Serial data-In to the JTAG circuit. Sampled on the rising edge of TCK. If the JTAG feature is not being utilized, this pin can be left floating or connected to V _{DD} through a pull-up resistor. This pin is not available on TQFP packages.
TMS	-	-	U2	R5	JTAG serial input Synchronous	Serial data-In to the JTAG circuit. Sampled on the rising edge of TCK. If the JTAG feature is not being utilized, this pin can be disconnected or connected to V _{DD} . This pin is not available on TQFP packages.
TCK	-	-	U4	R7	JTAG-Clock	Clock input to the JTAG circuitry. If the JTAG feature is not being utilized, this pin must be connected to V _{SS} . This pin is not available on TQFP packages.
NC	1,2,3,6,7, 14,16,25, 28,29,30, 38,39,42, 51,52,53, 56,57,66, 75,78,79, 95,96	1,2,3,6,7, 14,16,25, 28,29,30, 38,39,42, 43,51,52, 53,56,57, 66,75,78, 79,95,96	B1,B7, C1,C7, D2,D4, D7,E1, E6,H2, F2,G1, G6,H7, J3,J5,K1, K6,L4,L2, L7,M6, N2,L7,P1, P6,R1, R5,R7, T1,T4,U6	A5,B1,B4, C1,C2,C10, D1,D10, E1,E10,F1, F10,G1, G10,H1,H3, H9,H10,J2, J11,K2, K11,L2,L1, M2,M11, N2,N7,N10, N5,N11,P1, A1,B11,P2, R2,N6	-	No Connects. Not internally connected to the die.

Functional Overview

All synchronous inputs pass through input registers controlled by the rising edge of the clock. All data outputs pass through output registers controlled by the rising edge of the clock. Maximum access delay from the clock rise (t_{CO}) is 3.0 ns (200-MHz device).

The CY7C1360B/CY7C1362B supports secondary cache in systems utilizing either a linear or interleaved burst sequence. The interleaved burst order supports Pentium and i486™ processors. The linear burst sequence is suited for processors that utilize a linear burst sequence. The burst order is user selectable, and is determined by sampling the MODE input. Accesses can be initiated with either the Processor Address Strobe (ADSP) or the Controller Address Strobe (ADSC). Address advancement through the burst sequence is controlled by the ADV input. A two-bit on-chip wraparound burst counter captures the first address in a burst sequence and automatically increments the address for the rest of the burst access.

Byte Write operations are qualified with the Byte Write Enable (BWE) and Byte Write Select (BW_X) inputs. A Global Write Enable (GW) overrides all Byte Write inputs and writes data to all four bytes. All writes are simplified with on-chip synchronous self-timed Write circuitry.

Three synchronous Chip Selects (\overline{CE}_1 , CE_2 , $\overline{CE}_3^{[2]}$) and an asynchronous Output Enable (OE) provide for easy bank selection and output three-state control. ADSP is ignored if \overline{CE}_1 is HIGH.

Single Read Accesses

This access is initiated when the following conditions are satisfied at clock rise: (1) ADSP or ADSC is asserted LOW, (2) \overline{CE}_1 , CE_2 , $\overline{CE}_3^{[2]}$ are all asserted active, and (3) the Write signals (GW, BWE) are all deasserted HIGH. ADSP is ignored if \overline{CE}_1 is HIGH. The address presented to the address inputs (A) is stored into the address advancement logic and the address register while being presented to the memory array. The corresponding data is allowed to propagate to the input of the output registers. At the rising edge of the next clock the data is allowed to propagate through the output register and onto the data bus within 3.0 ns (200-MHz device) if OE is active LOW. The only exception occurs when the SRAM is emerging from a deselected state to a selected state, its outputs are always three-stated during the first cycle of the access. After the first cycle of the access, the outputs are controlled by the OE signal. Consecutive single Read cycles are supported. Once the SRAM is deselected at clock rise by the chip select and either ADSP or ADSC signals, its output will three-state immediately.

Single Write Accesses Initiated by ADSP

This access is initiated when both of the following conditions are satisfied at clock rise: (1) ADSP is asserted LOW, and (2) \overline{CE}_1 , CE_2 , $\overline{CE}_3^{[2]}$ are all asserted active. The address presented to A is loaded into the address register and the address advancement logic while being delivered to the memory array. The Write signals (GW, BWE, and BW_X) and ADV inputs are ignored during this first cycle.

ADSP-triggered Write accesses require two clock cycles to complete. If GW is asserted LOW on the second clock rise, the data presented to the DQs inputs is written into the corresponding address location in the memory array. If GW is HIGH,

then the Write operation is controlled by \overline{BWE} and $\overline{BW_X}$ signals. The CY7C1360B/CY7C1362B provides Byte Write capability that is described in the Write Cycle Descriptions table. Asserting the Byte Write Enable input (BWE) with the selected Byte Write (BW_X) input, will selectively write to only the desired bytes. Bytes not selected during a Byte Write operation will remain unaltered. A synchronous self-timed Write mechanism has been provided to simplify the Write operations.

Because the CY7C1360B/CY7C1362B is a common I/O device, the Output Enable (OE) must be deasserted HIGH before presenting data to the DQs inputs. Doing so will three-state the output drivers. As a safety precaution, DQs are automatically three-stated whenever a Write cycle is detected, regardless of the state of OE.

Single Write Accesses Initiated by ADSC

ADSC Write accesses are initiated when the following conditions are satisfied: (1) ADSC is asserted LOW, (2) ADSP is deasserted HIGH, (3) \overline{CE}_1 , CE_2 , $\overline{CE}_3^{[2]}$ are all asserted active, and (4) the appropriate combination of the Write inputs (GW, BWE, and BW_X) are asserted active to conduct a Write to the desired byte(s). ADSC-triggered Write accesses require a single clock cycle to complete. The address presented to A is loaded into the address register and the address advancement logic while being delivered to the memory array. The ADV input is ignored during this cycle. If a global Write is conducted, the data presented to the DQs is written into the corresponding address location in the memory core. If a Byte Write is conducted, only the selected bytes are written. Bytes not selected during a Byte Write operation will remain unaltered. A synchronous self-timed Write mechanism has been provided to simplify the Write operations.

Because the CY7C1360B/CY7C1362B is a common I/O device, the Output Enable (OE) must be deasserted HIGH before presenting data to the DQs inputs. Doing so will three-state the output drivers. As a safety precaution, DQs are automatically three-stated whenever a Write cycle is detected, regardless of the state of OE.

Burst Sequences

The CY7C1360B/CY7C1362B provides a two-bit wraparound counter, fed by A_1 , A_0 , that implements either an interleaved or linear burst sequence. The interleaved burst sequence is designed specifically to support Intel Pentium applications. The linear burst sequence is designed to support processors that follow a linear burst sequence. The burst sequence is user selectable through the MODE input.

Asserting ADV LOW at clock rise will automatically increment the burst counter to the next address in the burst sequence. Both Read and Write burst operations are supported.

Sleep Mode

The ZZ input pin is an asynchronous input. Asserting ZZ places the SRAM in a power conservation "sleep" mode. Two clock cycles are required to enter into or exit from this "sleep" mode. While in this mode, data integrity is guaranteed. Accesses pending when entering the "sleep" mode are not considered valid nor is the completion of the operation guaranteed. The device must be deselected prior to entering the "sleep" mode. \overline{CE}_1 , CE_2 , $\overline{CE}_3^{[2]}$, ADSP, and ADSC must remain inactive for the duration of t_{ZZREC} after the ZZ input returns LOW.

Interleaved Burst Address Table
(MODE = Floating or V_{DD})

First Address A ₁ , A ₀	Second Address A ₁ , A ₀	Third Address A ₁ , A ₀	Fourth Address A ₁ , A ₀
00	01	10	11
01	00	11	10
10	11	00	01
11	10	01	00

Linear Burst Address Table
(MODE = GND)

First Address A ₁ , A ₀	Second Address A ₁ , A ₀	Third Address A ₁ , A ₀	Fourth Address A ₁ , A ₀
00	01	10	11
01	10	11	00
10	11	00	01
11	00	01	10

ZZ Mode Electrical Characteristics

Parameter	Description	Test Conditions	Min.	Max.	Unit
I _{DDZZ}	Snooze mode standby current	ZZ ≥ V _{DD} - 0.2V		35	mA
t _{ZZS}	Device operation to ZZ	ZZ ≥ V _{DD} - 0.2V		2t _{CYC}	ns
t _{ZZREC}	ZZ recovery time	ZZ ≤ 0.2V	2t _{CYC}		ns
t _{ZZI}	ZZ Active to snooze current	This parameter is sampled		2t _{CYC}	ns
t _{RZZI}	ZZ Inactive to exit snooze current	This parameter is sampled	0		ns

Truth Table^[3, 4, 5, 6, 7, 8]

Operation	Add. Used	\overline{CE}_1	CE_2	\overline{CE}_3	ZZ	\overline{ADSP}	\overline{ADSC}	\overline{ADV}	\overline{WRITE}	\overline{OE}	CLK	DQ
Deselect Cycle, Power Down	None	H	X	X	L	X	L	X	X	X	L-H	Three-State
Deselect Cycle, Power Down	None	L	L	X	L	L	X	X	X	X	L-H	Three-State
Deselect Cycle, Power Down	None	L	X	H	L	L	X	X	X	X	L-H	Three-State
Deselect Cycle, Power Down	None	L	L	X	L	H	L	X	X	X	L-H	Three-State
Deselect Cycle, Power Down	None	L	X	H	L	H	L	X	X	X	L-H	Three-State
Snooze Mode, Power Down	None	X	X	X	H	X	X	X	X	X	X	Three-State
READ Cycle, Begin Burst	External	L	H	L	L	L	X	X	X	L	L-H	Q
READ Cycle, Begin Burst	External	L	H	L	L	L	X	X	X	H	L-H	Three-State
WRITE Cycle, Begin Burst	External	L	H	L	L	H	L	X	L	X	L-H	D
READ Cycle, Begin Burst	External	L	H	L	L	H	L	X	H	L	L-H	Q
READ Cycle, Begin Burst	External	L	H	L	L	H	L	X	H	H	L-H	Three-State
READ Cycle, Continue Burst	Next	X	X	X	L	H	H	L	H	L	L-H	Q
READ Cycle, Continue Burst	Next	X	X	X	L	H	H	L	H	H	L-H	Three-State
READ Cycle, Continue Burst	Next	H	X	X	L	X	H	L	H	L	L-H	Q
READ Cycle, Continue Burst	Next	H	X	X	L	X	H	L	H	H	L-H	Three-State
WRITE Cycle, Continue Burst	Next	X	X	X	L	H	H	L	L	X	L-H	D
WRITE Cycle, Continue Burst	Next	H	X	X	L	X	H	L	L	X	L-H	D
READ Cycle, Suspend Burst	Current	X	X	X	L	H	H	H	H	L	L-H	Q
READ Cycle, Suspend Burst	Current	X	X	X	L	H	H	H	H	H	L-H	Three-State
READ Cycle, Suspend Burst	Current	H	X	X	L	X	H	H	H	L	L-H	Q
READ Cycle, Suspend Burst	Current	H	X	X	L	X	H	H	H	H	L-H	Three-State
WRITE Cycle, Suspend Burst	Current	X	X	X	L	H	H	H	L	X	L-H	D
WRITE Cycle, Suspend Burst	Current	H	X	X	L	X	H	H	L	X	L-H	D

Notes:

3. X = "Don't Care." H = Logic HIGH, L = Logic LOW.
4. \overline{WRITE} = L when any one or more Byte Write Enable signals and \overline{BWE} = L or \overline{GW} = L. \overline{WRITE} = H when all Byte Write Enable signals, \overline{BWE} , \overline{GW} = H.
5. The DQ pins are controlled by the current cycle and the \overline{OE} signal. \overline{OE} is asynchronous and is not sampled with the clock.
6. \overline{CE}_1 , CE_2 , and \overline{CE}_3 are available only in the TQFP package. BGA package has only 2 chip selects \overline{CE}_1 and CE_2 .
7. The SRAM always initiates a read cycle when \overline{ADSP} is asserted, regardless of the state of \overline{GW} , \overline{BWE} , or \overline{BW}_x . Writes may occur only on subsequent clocks after the \overline{ADSP} or with the assertion of \overline{ADSC} . As a result, \overline{OE} must be driven HIGH prior to the start of the Write cycle to allow the outputs to three-state. \overline{OE} is a don't care for the remainder of the Write cycle.
8. \overline{OE} is asynchronous and is not sampled with the clock rise. It is masked internally during Write cycles. During a Read cycle all data bits are Three-State when \overline{OE} is inactive or when the device is deselected, and all data bits behave as output when \overline{OE} is active (LOW).
9. Table only lists a partial listing of the byte write combinations. Any combination of $\overline{BW}_{[A,D]}$ is valid. Appropriate write will be done based on which byte write is active.

Partial Truth Table for Read/Write^[5, 9]

Function (CY7C1360B)	\overline{GW}	\overline{BWE}	$\overline{BW_D}$	$\overline{BW_C}$	$\overline{BW_B}$	$\overline{BW_A}$
Read	H	H	X	X	X	X
Read	H	L	H	H	H	H
Write Byte A – (DQ _A and DQP _A)	H	L	H	H	H	L
Write Byte B – (DQ _B and DQP _B)	H	L	H	H	L	H
Write Bytes B, A	H	L	H	H	L	L
Write Byte C – (DQ _C and DQP _C)	H	L	H	L	H	H
Write Bytes C, A	H	L	H	L	H	L
Write Bytes C, B	H	L	H	L	L	H
Write Bytes C, B, A	H	L	H	L	L	L
Write Byte D – (DQ _D and DQP _D)	H	L	L	H	H	H
Write Bytes D, A	H	L	L	H	H	L
Write Bytes D, B	H	L	L	H	L	H
Write Bytes D, B, A	H	L	L	H	L	L
Write Bytes D, C	H	L	L	L	H	H
Write Bytes D, C, A	H	L	L	L	H	L
Write Bytes D, C, B	H	L	L	L	L	H
Write All Bytes	H	L	L	L	L	L
Write All Bytes	L	X	X	X	X	X

Truth Table for Read/Write^[5]

Function (CY7C1362B)	\overline{GW}	\overline{BWE}	$\overline{BW_B}$	$\overline{BW_A}$
Read	H	H	X	X
Read	H	L	H	H
Write Byte A – (DQ _A and DQP _A)	H	L	H	L
Write Byte B – (DQ _B and DQP _B)	H	L	L	H
Write Bytes B, A	H	L	L	L
Write All Bytes	H	L	L	L
Write All Bytes	L	X	X	X

IEEE 1149.1 Serial Boundary Scan (JTAG)

The CY7C1360B/CY7C1362B incorporates a serial boundary scan test access port (TAP). This port operates in accordance with IEEE Standard 1149.1-1990 but does not have the set of functions required for full 1149.1 compliance. These functions from the IEEE specification are excluded because their inclusion places an added delay in the critical speed path of the SRAM. Note that the TAP controller functions in a manner that does not conflict with the operation of other devices using 1149.1 fully compliant TAPs. The TAP operates using JEDEC-standard 3.3V or 2.5V I/O logic levels.

The CY7C1360B/CY7C1362B contains a TAP controller, instruction register, boundary scan register, bypass register, and ID register.

Disabling the JTAG Feature

It is possible to operate the SRAM without using the JTAG feature. To disable the TAP controller, TCK must be tied LOW (V_{SS}) to prevent clocking of the device. TDI and TMS are internally pulled up and may be unconnected. They may alternately be connected to V_{DD} through a pull-up resistor. TDO should be left unconnected. Upon power-up, the device will come up in a reset state which will not interfere with the operation of the device.

TAP Controller State Diagram

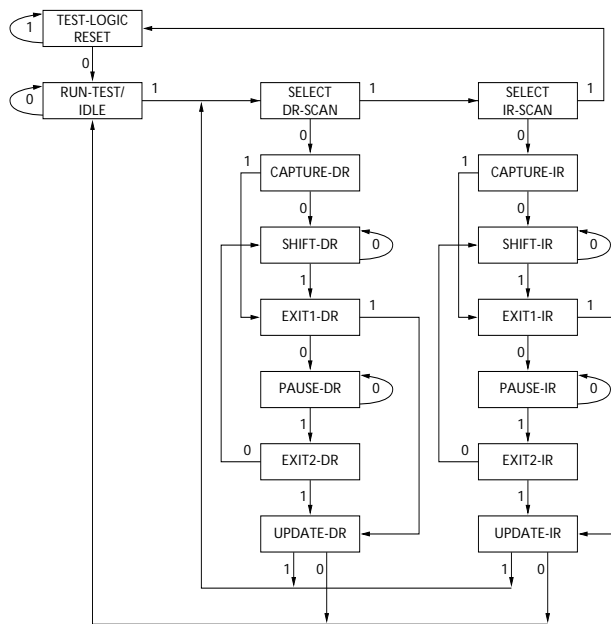

The 0/1 next to each state represents the value of TMS at the rising edge of TCK.

Test Access Port (TAP)

Test Clock (TCK)

The test clock is used only with the TAP controller. All inputs are captured on the rising edge of TCK. All outputs are driven from the falling edge of TCK.

Test MODE SELECT (TMS)

The TMS input is used to give commands to the TAP controller and is sampled on the rising edge of TCK. It is allowable to leave this ball unconnected if the TAP is not used. The ball is pulled up internally, resulting in a logic HIGH level.

Test Data-In (TDI)

The TDI ball is used to serially input information into the registers and can be connected to the input of any of the registers. The register between TDI and TDO is chosen by the instruction that is loaded into the TAP instruction register. For information on loading the instruction register, see **Figure**. TDI is internally pulled up and can be unconnected if the TAP is unused in an application. TDI is connected to the most significant bit (MSB) of any register. (See Tap Controller Block Diagram.)

Test Data-Out (TDO)

The TDO output ball is used to serially clock data-out from the registers. The output is active depending upon the current state of the TAP state machine. The output changes on the falling edge of TCK. TDO is connected to the least significant bit (LSB) of any register. (See Tap Controller State Diagram.)

TAP Controller Block Diagram

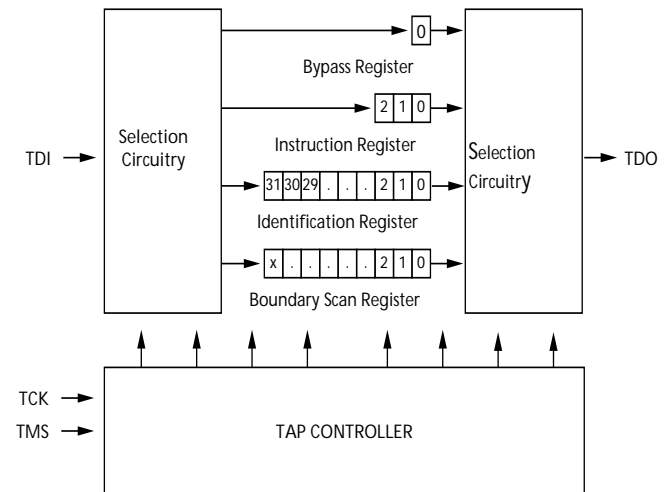

Performing a TAP Reset

A RESET is performed by forcing TMS HIGH (V_{DD}) for five rising edges of TCK. This RESET does not affect the operation of the SRAM and may be performed while the SRAM is operating.

At power-up, the TAP is reset internally to ensure that TDO comes up in a High-Z state.

TAP Registers

Registers are connected between the TDI and TDO balls and allow data to be scanned into and out of the SRAM test circuitry. Only one register can be selected at a time through the instruction register. Data is serially loaded into the TDI ball on the rising edge of TCK. Data is output on the TDO ball on the falling edge of TCK.

Instruction Register

Three-bit instructions can be serially loaded into the instruction register. This register is loaded when it is placed between the TDI and TDO balls as shown in the Tap Controller Block Diagram. Upon power-up, the instruction register is loaded with the IDCODE instruction. It is also loaded with the IDCODE instruction if the controller is placed in a reset state as described in the previous section.

When the TAP controller is in the Capture-IR state, the two least significant bits are loaded with a binary "01" pattern to allow for fault isolation of the board-level serial test data path.

Bypass Register

To save time when serially shifting data through registers, it is sometimes advantageous to skip certain chips. The bypass register is a single-bit register that can be placed between the TDI and TDO balls. This allows data to be shifted through the SRAM with minimal delay. The bypass register is set LOW (V_{SS}) when the BYPASS instruction is executed.

Boundary Scan Register

The boundary scan register is connected to all the input and bidirectional balls on the SRAM. The SRAM has a 71-bit-long register.

The boundary scan register is loaded with the contents of the RAM I/O ring when the TAP controller is in the Capture-DR state and is then placed between the TDI and TDO balls when the controller is moved to the Shift-DR state. The EXTEST, SAMPLE/PRELOAD and SAMPLE Z instructions can be used to capture the contents of the I/O ring.

The Boundary Scan Order tables show the order in which the bits are connected. Each bit corresponds to one of the bumps on the SRAM package. The MSB of the register is connected to TDI and the LSB is connected to TDO.

Identification (ID) Register

The ID register is loaded with a vendor-specific, 32-bit code during the Capture-DR state when the IDCODE command is loaded in the instruction register. The IDCODE is hardwired into the SRAM and can be shifted out when the TAP controller is in the Shift-DR state. The ID register has a vendor code and other information described in the Identification Register Definitions table.

TAP Instruction Set

Overview

Eight different instructions are possible with the three-bit instruction register. All combinations are listed in the Instruction Codes table. Three of these instructions are listed as RESERVED and should not be used. The other five instructions are described in detail below.

The TAP controller used in this SRAM is not fully compliant to the 1149.1 convention because some of the mandatory 1149.1 instructions are not fully implemented.

The TAP controller cannot be used to load address data or control signals into the SRAM and cannot preload the I/O buffers. The SRAM does not implement the 1149.1 commands EXTEST or INTEST or the PRELOAD portion of SAMPLE/PRELOAD; rather, it performs a capture of the I/O ring when these instructions are executed.

Instructions are loaded into the TAP controller during the Shift-IR state when the instruction register is placed between TDI and TDO. During this state, instructions are shifted through the instruction register through the TDI and TDO balls. To execute the instruction once it is shifted in, the TAP controller needs to be moved into the Update-IR state.

EXTEST

EXTEST is a mandatory 1149.1 instruction which is to be executed whenever the instruction register is loaded with all 0s. EXTEST is not implemented in this SRAM TAP controller, and therefore this device is not compliant to 1149.1. The TAP controller does not recognize an all-0 instruction.

When an EXTEST instruction is loaded into the instruction register, the SRAM responds as if a SAMPLE/PRELOAD instruction has been loaded. There is one difference between the two instructions. Unlike the SAMPLE/PRELOAD instruction, EXTEST places the SRAM outputs in a High-Z state.

IDCODE

The IDCODE instruction causes a vendor-specific, 32-bit code to be loaded into the instruction register. It also places the instruction register between the TDI and TDO balls and allows the IDCODE to be shifted out of the device when the TAP controller enters the Shift-DR state.

The IDCODE instruction is loaded into the instruction register upon power-up or whenever the TAP controller is given a test logic reset state.

SAMPLE Z

The SAMPLE Z instruction causes the boundary scan register to be connected between the TDI and TDO balls when the TAP controller is in a Shift-DR state. It also places all SRAM outputs into a High-Z state.

SAMPLE/PRELOAD

SAMPLE/PRELOAD is a 1149.1 mandatory instruction. The PRELOAD portion of this instruction is not implemented, so the device TAP controller is not fully 1149.1 compliant.

When the SAMPLE/PRELOAD instruction is loaded into the instruction register and the TAP controller is in the Capture-DR state, a snapshot of data on the inputs and bidirectional balls is captured in the boundary scan register.

The user must be aware that the TAP controller clock can only operate at a frequency up to 10 MHz, while the SRAM clock operates more than an order of magnitude faster. Because there is a large difference in the clock frequencies, it is possible that during the Capture-DR state, an input or output will undergo a transition. The TAP may then try to capture a signal while in transition (metastable state). This will not harm the device, but there is no guarantee as to the value that will be captured. Repeatable results may not be possible.

To guarantee that the boundary scan register will capture the correct value of a signal, the SRAM signal must be stabilized long enough to meet the TAP controller's capture set-up plus hold time (t_{CS} plus t_{CH}).

The SRAM clock input might not be captured correctly if there is no way in a design to stop (or slow) the clock during a SAMPLE/PRELOAD instruction. If this is an issue, it is still

possible to capture all other signals and simply ignore the value of the CLK captured in the boundary scan register.

Once the data is captured, it is possible to shift out the data by putting the TAP into the Shift-DR state. This places the boundary scan register between the TDI and TDO balls.

Note that since the PRELOAD part of the command is not implemented, putting the TAP to the Update-DR state while performing a SAMPLE/PRELOAD instruction will have the same effect as the Pause-DR command.

BYPASS

When the BYPASS instruction is loaded in the instruction register and the TAP is placed in a Shift-DR state, the bypass register is placed between the TDI and TDO balls. The advantage of the BYPASS instruction is that it shortens the boundary scan path when multiple devices are connected together on a board.

Reserved

These instructions are not implemented but are reserved for future use. Do not use these instructions.

TAP Timing

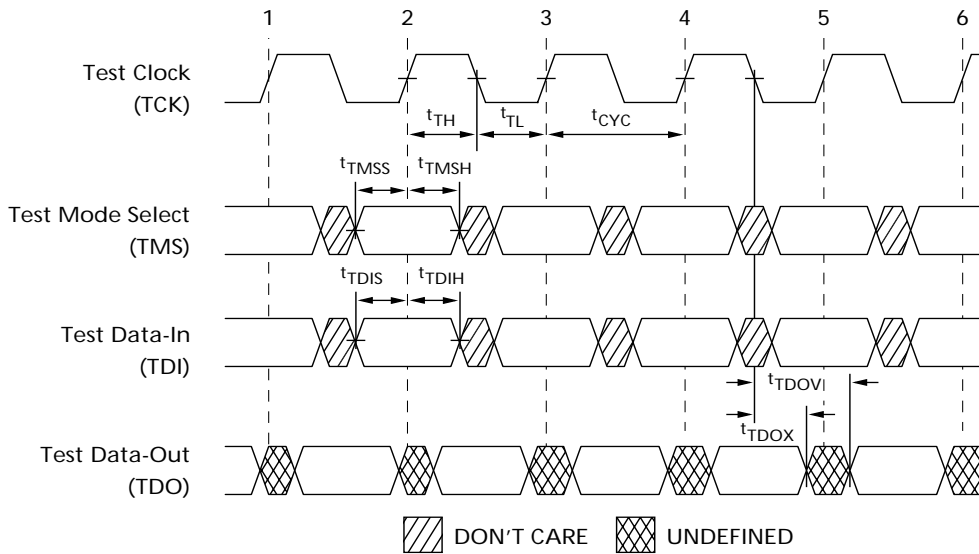

TAP AC Switching Characteristics Over the Operating Range^[10, 11]

Parameter	Description	Min.	Max.	Unit
Clock				
t_{TCYC}	TCK Clock Cycle Time	50		ns
t_{TF}	TCK Clock Frequency		20	MHz
t_{TH}	TCK Clock HIGH time	25		ns
t_{TL}	TCK Clock LOW time	25		ns
Output Times				
t_{TDOV}	TCK Clock LOW to TDO Valid		5	ns
t_{TDOX}	TCK Clock LOW to TDO Invalid	0		ns
Set-up Times				
t_{TMSS}	TMS Set-up to TCK Clock Rise	5		ns
t_{TDIS}	TDI Set-up to TCK Clock Rise	5		ns
t_{CS}	Capture Set-up to TCK Rise	5		
Hold Times				
t_{TMSH}	TMS hold after TCK Clock Rise	5		ns
t_{TDIH}	TDI Hold after Clock Rise	5		ns
t_{CH}	Capture Hold after Clock Rise	5		ns

Notes:

10. t_{CS} and t_{CH} refer to the set-up and hold time requirements of latching data from the boundary scan register.

11. Test conditions are specified using the load in TAP AC test Conditions. $t_r/t_f = 1$ ns.

3.3V TAP AC Test Conditions

Input pulse levels V_{SS} to 3.3V
 Input rise and fall times 1 ns
 Input timing reference levels 1.5V
 Output reference levels 1.5V
 Test load termination supply voltage 1.5V

2.5V TAP AC Test Conditions

Input pulse levels V_{SS} to 2.5V
 Input rise and fall time 1 ns
 Input timing reference levels 1.25V
 Output reference levels 1.25V
 Test load termination supply voltage 1.25V

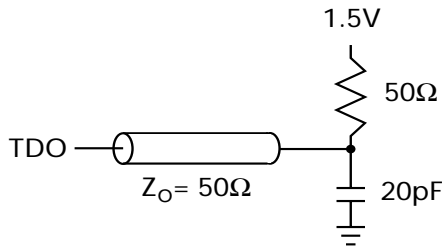
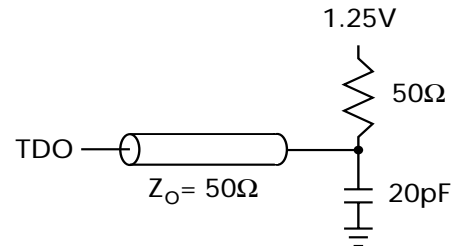
3.3V TAP AC Output Load Equivalent

2.5V TAP AC Output Load Equivalent

TAP DC Electrical Characteristics And Operating Conditions

($0^{\circ}\text{C} < T_A < +70^{\circ}\text{C}$; $V_{DD} = 3.3\text{V} \pm 0.165\text{V}$ unless otherwise noted)^[12]

Parameter	Description	Conditions		Min.	Max.	Unit
V_{OH1}	Output HIGH Voltage	$I_{OH} = -4.0\text{ mA}$	$V_{DDQ} = 3.3\text{V}$	2.4		V
		$I_{OH} = -1.0\text{ mA}$	$V_{DDQ} = 2.5\text{V}$	2.0		V
V_{OH2}	Output HIGH Voltage	$I_{OH} = -100\text{ }\mu\text{A}$	$V_{DDQ} = 3.3\text{V}$	2.9		V
			$V_{DDQ} = 2.5\text{V}$	2.1		V
V_{OL1}	Output LOW Voltage	$I_{OL} = 8.0\text{ mA}$	$V_{DDQ} = 3.3\text{V}$		0.4	V
		$I_{OL} = 8.0\text{ mA}$	$V_{DDQ} = 2.5\text{V}$		0.4	V
V_{OL2}	Output LOW Voltage	$I_{OL} = 100\text{ }\mu\text{A}$	$V_{DDQ} = 3.3\text{V}$		0.2	V
			$V_{DDQ} = 2.5\text{V}$		0.2	V
V_{IH}	Input HIGH Voltage		$V_{DDQ} = 3.3\text{V}$	2.0	$V_{DD} + 0.3$	V
			$V_{DDQ} = 2.5\text{V}$	1.7	$V_{DD} + 0.3$	V
V_{IL}	Input LOW Voltage		$V_{DDQ} = 3.3\text{V}$	-0.5	0.7	V
			$V_{DDQ} = 2.5\text{V}$	-0.3	0.7	V
I_X	Input Load Current	$\text{GND} \leq V_{IN} \leq V_{DDQ}$		-5	5	μA

Note:

12. All voltages referenced to V_{SS} (GND).

Identification Register Definitions

Instruction Field	CY7C1360B (256KX36)	CY7C1362B (512KX18)	Description
Revision Number (31:29)	001	001	Describes the version number
Device Depth (28:24)	01010	01010	Reserved for Internal Use
Device Width (23:18)	000000	000000	Defines memory type and architecture
Cypress Device ID (17:12)	100110	010110	Defines width and density
Cypress JEDEC ID Code (11:1)	00000110100	00000110100	Allows unique identification of SRAM vendor
ID Register Presence Indicator (0)	1	1	Indicates the presence of an ID register

Scan Register Sizes

Register Name	Bit Size(x36)	Bit Size(x18)
Instruction	3	3
Bypass	1	1
ID	32	32
Boundary Scan Order	71	71

Identification Codes

Instruction	Code	Description
EXTEST	000	Captures I/O ring contents. Places the boundary scan register between TDI and TDO. Forces all SRAM outputs to High-Z state. This instruction is not 1149.1 compliant.
IDCODE	001	Loads the ID register with the vendor ID code and places the register between TDI and TDO. This operation does not affect SRAM operations.
SAMPLE Z	010	Captures I/O ring contents. Places the boundary scan register between TDI and TDO. Forces all SRAM output drivers to a High-Z state.
RESERVED	011	Do Not Use: This instruction is reserved for future use.
SAMPLE/PRELOAD	100	Captures I/O ring contents. Places the boundary scan register between TDI and TDO. Does not affect SRAM operation. This instruction does not implement 1149.1 preload function and is therefore not 1149.1 compliant.
RESERVED	101	Do Not Use: This instruction is reserved for future use.
RESERVED	110	Do Not Use: This instruction is reserved for future use.
BYPASS	111	Places the bypass register between TDI and TDO. This operation does not affect SRAM operations.

119-Ball BGA Boundary Scan Order

CY7C1360B (256K x 36)					
BIT #	BALL ID	Signal Name	BIT #	BALL ID	Signal Name
1	K4	CLK	37	P4	A0
2	H4	\overline{GW}	38	N4	A1
3	M4	\overline{BWE}	39	R6	A
4	F4	\overline{OE}	40	T5	A
5	B4	\overline{ADSC}	41	T3	A
6	A4	\overline{ADSP}	42	R2	A
7	G4	\overline{ADV}	43	R3	MODE
8	C3	A	44	P2	DQP _D
9	B3	A	45	P1	DQ _D
10	D6	DQP _B	46	L2	DQ _D
11	H7	DQ _B	47	K1	DQ _D
12	G6	DQ _B	48	N2	DQ _D
13	E6	DQ _B	49	N1	DQ _D
14	D7	DQ _B	50	M2	DQ _D
15	E7	DQ _B	51	L1	DQ _D
16	F6	DQ _B	52	K2	DQ _D
17	G7	DQ _B	53	Internal	Internal
18	H6	DQ _B	54	H1	DQ _C
19	T7	ZZ	55	G2	DQ _C
20	K7	DQ _A	56	E2	DQ _C
21	L6	DQ _A	57	D1	DQ _C
22	N6	DQ _A	58	H2	DQ _C
23	P7	DQ _A	59	G1	DQ _C
24	N7	DQ _A	60	F2	DQ _C
25	M6	DQ _A	61	E1	DQ _C
26	L7	DQ _A	62	D2	DQP _C
27	K6	DQ _A	63	C2	A
28	P6	DQP _A	64	A2	A
29	T4	A	65	E4	\overline{CE}_1
30	A3	A	66	B2	CE_2
31	C5	A	67	L3	\overline{BW}_D
32	B5	A	68	G3	\overline{BW}_C
33	A5	A	69	G5	\overline{BW}_B
34	C6	A	70	L5	\overline{BW}_A
35	A6	A	71	Internal	Internal
36	B6	A			

CY7C1362B (512K x 18)					
BIT#	BALL ID	Signal Name	BIT#	BALL ID	Signal Name
1	K4	CLK	37	P4	A0
2	H4	\overline{GW}	38	N4	A1
3	M4	\overline{BWE}	39	R6	A
4	F4	\overline{OE}	40	T5	A
5	B4	\overline{ADSC}	41	T3	A
6	A4	\overline{ADSP}	42	R2	A
7	G4	\overline{ADV}	43	R3	MODE
8	C3	A	44	Internal	Internal
9	B3	A	45	Internal	Internal
10	T2	A	46	Internal	Internal
11	Internal	Internal	47	Internal	Internal
12	Internal	Internal	48	P2	DQP _B
13	Internal	Internal	49	N1	DQ _B
14	D6	DQP _A	50	M2	DQ _B
15	E7	DQ _A	51	L1	DQ _B
16	F6	DQ _A	52	K2	DQ _B
17	G7	DQ _A	53	Internal	Internal
18	H6	DQ _A	54	H1	DQ _B
19	T7	ZZ	55	G2	DQ _B
20	K7	DQ _A	56	E2	DQ _B
21	L6	DQ _A	57	D1	DQ _B
22	N6	DQ _A	58	Internal	Internal
23	P7	DQ _A	59	Internal	Internal
24	Internal	Internal	60	Internal	Internal
25	Internal	Internal	61	Internal	Internal
26	Internal	Internal	62	Internal	Internal
27	Internal	Internal	63	C2	A
28	Internal	Internal	64	A2	A
29	T6	A	65	E4	\overline{CE}_1
30	A3	A	66	B2	CE_2
31	C5	A	67	Internal	Internal
32	B5	A	68	Internal	Internal
33	A5	A	69	G3	\overline{BW}_B
34	C6	A	70	L5	\overline{BW}_A
35	A6	A	71	Internal	Internal
36	B6	A			

165-Ball fBGA Boundary Scan Order

CY7C1360B (256K x 36)					
BIT#	BALL ID	Signal Name	BIT#	BALL ID	Signal Name
1	B6	CLK	37	R6	A0
2	B7	\overline{GW}	38	P6	A1
3	A7	\overline{BWE}	39	R4	A
4	B8	\overline{OE}	40	P4	A
5	A8	\overline{ADSC}	41	R3	A
6	B9	\overline{ADSP}	42	P3	A
7	A9	\overline{ADV}	43	R1	MODE
8	B10	A	44	N1	DQP _D
9	A10	A	45	L2	DQ _D
10	C11	DQP _B	46	K2	DQ _D
11	E10	DQ _B	47	J2	DQ _D
12	F10	DQ _B	48	M2	DQ _D
13	G10	DQ _B	49	M1	DQ _D
14	D10	DQ _B	50	L1	DQ _D
15	D11	DQ _B	51	K1	DQ _D
16	E11	DQ _B	52	J1	DQ _D
17	F11	DQ _B	53	Internal	Internal
18	G11	DQ _B	54	G2	DQ _C
19	H11	ZZ	55	F2	DQ _C
20	J10	DQ _A	56	E2	DQ _C
21	K10	DQ _A	57	D2	DQ _C
22	L10	DQ _A	58	G1	DQ _C
23	M10	DQ _A	59	F1	DQ _C
24	J11	DQ _A	60	E1	DQ _C
25	K11	DQ _A	61	D1	DQ _C
26	L11	DQ _A	62	C1	DQP _C
27	M11	DQ _A	63	B2	A
28	N11	DQP _A	64	A2	A
29	R11	A	65	A3	\overline{CE}_1
30	R10	A	66	B3	CE_2
31	P10	A	67	B4	\overline{BW}_D
32	R9	A	68	A4	\overline{BW}_C
33	P9	A	69	A5	\overline{BW}_B
34	R8	A	70	B5	\overline{BW}_A
35	P8	A	71	A6	\overline{CE}_3
36	P11	A			

CY7C1362B (512K x 18)					
BIT#	BALL ID	Signal Name	BIT#	BALL ID	Signal Name
1	B6	CLK	37	R6	A0
2	B7	\overline{GW}	38	P6	A1
3	A7	\overline{BWE}	39	R4	A
4	B8	\overline{OE}	40	P4	A
5	A8	\overline{ADSC}	41	R3	A
6	B9	\overline{ADSP}	42	P3	A
7	A9	\overline{ADV}	43	R1	MODE
8	B10	A	44	Internal	Internal
9	A10	A	45	Internal	Internal
10	A11	A	46	Internal	Internal
11	Internal	Internal	47	Internal	Internal
12	Internal	Internal	48	N1	DQP _B
13	Internal	Internal	49	M1	DQ _B
14	C11	DQP _A	50	L1	DQ _B
15	D11	DQ _A	51	K1	DQ _B
16	E11	DQ _A	52	J1	DQ _B
17	F11	DQ _A	53	Internal	Internal
18	G11	DQ _A	54	G2	DQ _B
19	H11	ZZ	55	F2	DQ _B
20	J10	DQ _A	56	E2	DQ _B
21	K10	DQ _A	57	D2	DQ _B
22	L10	DQ _A	58	Internal	Internal
23	M10	DQ _A	59	Internal	Internal
24	Internal	Internal	60	Internal	Internal
25	Internal	Internal	61	Internal	Internal
26	Internal	Internal	62	Internal	Internal
27	Internal	Internal	63	B2	A
28	Internal	Internal	64	A2	A
29	R11	A	65	A3	\overline{CE}_1
30	R10	A	66	B3	CE_2
31	P10	A	67	Internal	Internal
32	R9	A	68	Internal	Internal
33	P9	A	69	A4	\overline{BW}_B
34	R8	A	70	B5	\overline{BW}_A
35	P8	A	71	A6	\overline{CE}_3
36	P11	A			

Maximum Ratings

(Above which the useful life may be impaired. For user guidelines, not tested.)

Storage Temperature	-65°C to +150°C
Ambient Temperature with Power Applied.....	-55°C to +125°C
Supply Voltage on V _{DD} Relative to GND.....	-0.5V to +4.6V
DC Voltage Applied to Outputs in Three-State	-0.5V to V _{DDQ} + 0.5V
DC Input Voltage.....	-0.5V to V _{DD} + 0.5V

Current into Outputs (LOW).....	20 mA
Static Discharge Voltage.....	>2001V (per MIL-STD-883, Method 3015)
Latch-up Current.....	>200 mA

Operating Range

Range	Ambient Temperature	V _{DD}	V _{DDQ}
Commercial	0°C to +70°C	3.3V - 5%/+10%	2.5V - 5% to V _{DD}
Industrial	-40°C to +85°C		

Electrical Characteristics Over the Operating Range^[13, 14]

Parameter	Description	Test Conditions	Min.	Max.	Unit	
V _{DD}	Power Supply Voltage		3.135	3.6	V	
V _{DDQ}	I/O Supply Voltage	V _{DDQ} = 3.3V	3.135	V _{DD}	V	
		V _{DDQ} = 2.5V	2.375	2.625		
V _{OH}	Output HIGH Voltage	V _{DDQ} = 3.3V, V _{DD} = Min., I _{OH} = -4.0 mA	2.4		V	
		V _{DDQ} = 2.5V, V _{DD} = Min., I _{OH} = -1.0 mA	2.0		V	
V _{OL}	Output LOW Voltage	V _{DDQ} = 3.3V, V _{DD} = Min., I _{OL} = 8.0 mA		0.4	V	
		V _{DDQ} = 2.5V, V _{DD} = Min., I _{OL} = 1.0 mA		0.4	V	
V _{IH}	Input HIGH Voltage ^[13]	V _{DDQ} = 3.3V	2.0	V _{DD} + 0.3V	V	
		V _{DDQ} = 2.5V	1.7	V _{DD} + 0.3V	V	
V _{IL}	Input LOW Voltage ^[13]	V _{DDQ} = 3.3V	-0.3	0.8	V	
		V _{DDQ} = 2.5V	-0.3	0.7	V	
I _X	Input Load Current except ZZ and MODE	GND ≤ V _I ≤ V _{DDQ}	-5	5	μA	
		Input Current of MODE	Input = V _{SS}	-30		μA
	Input Current of ZZ	Input = V _{SS}	-5		μA	
		Input = V _{DD}		30	μA	
I _{OZ}	Output Leakage Current	GND ≤ V _I ≤ V _{DDQ} , Output Disabled	-5	5	μA	
I _{DD}	V _{DD} Operating Supply Current	V _{DD} = Max., I _{OUT} = 0 mA, f = f _{MAX} = 1/t _{CYC}	4.4-ns cycle, 225 MHz		250	mA
			5-ns cycle, 200 MHz		220	mA
			6-ns cycle, 166 MHz		180	mA
I _{SB1}	Automatic CE Power-down Current—TTL Inputs	V _{DD} = Max, Device Deselected, V _{IN} ≥ V _{IH} or V _{IN} ≤ V _{IL} , f = f _{MAX} = 1/t _{CYC}		50	mA	
I _{SB2}	Automatic CE Power-down Current—CMOS Inputs	V _{DD} = Max, Device Deselected, V _{IN} ≤ 0.3V or V _{IN} ≥ V _{DDQ} - 0.3V, f = 0		30	mA	
I _{SB3}	Automatic CE Power-down Current—CMOS Inputs	V _{DD} = Max, Device Deselected, or V _{IN} ≤ 0.3V or V _{IN} ≥ V _{DDQ} - 0.3V, f = f _{MAX} = 1/t _{CYC}		50	mA	
I _{SB4}	Automatic CE Power-down Current—TTL Inputs	V _{DD} = Max, Device Deselected, V _{IN} ≥ V _{IH} or V _{IN} ≤ V _{IL} , f = 0		40	mA	

Shaded areas contain advance information.

Notes:

13. Overshoot: V_{IH}(AC) < V_{DD} + 1.5V (Pulse width less than t_{CYC}/2), undershoot: V_{IL}(AC) > -2V (Pulse width less than t_{CYC}/2).
 14. T_{Power-up}: Assumes a linear ramp from 0V to V_{DD}(min.) within 200 ms. During this time V_{IH} ≤ V_{DD} and V_{DDQ} ≤ V_{DD}.

Thermal Resistance^[15]

Parameter	Description	Test Conditions	TQFP Package	BGA Package	fBGA Package	Unit
Θ_{JA}	Thermal Resistance (Junction to Ambient)	Test conditions follow standard test methods and procedures for measuring thermal impedance, per EIA / JESD51.	25	25	27	°C/W
Θ_{JC}	Thermal Resistance (Junction to Case)		9	6	6	°C/W

Capacitance^[15]

Parameter	Description	Test Conditions	TQFP Package	BGA Package	fBGA Package	Unit
C_{IN}	Input Capacitance	$T_A = 25^\circ\text{C}$, $f = 1\text{ MHz}$, $V_{DD} = 3.3\text{V}$, $V_{DDQ} = 2.5\text{V}$	5	5	5	pF
C_{CLK}	Clock Input Capacitance		5	5	5	pF
$C_{I/O}$	Input/Output Capacitance		5	7	7	pF

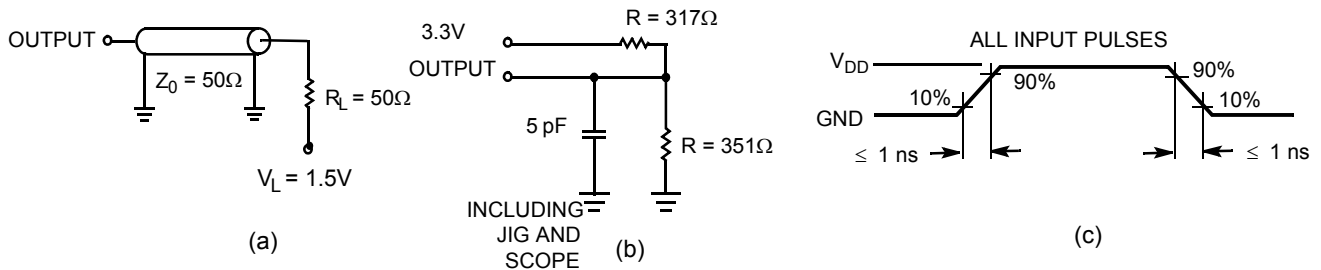
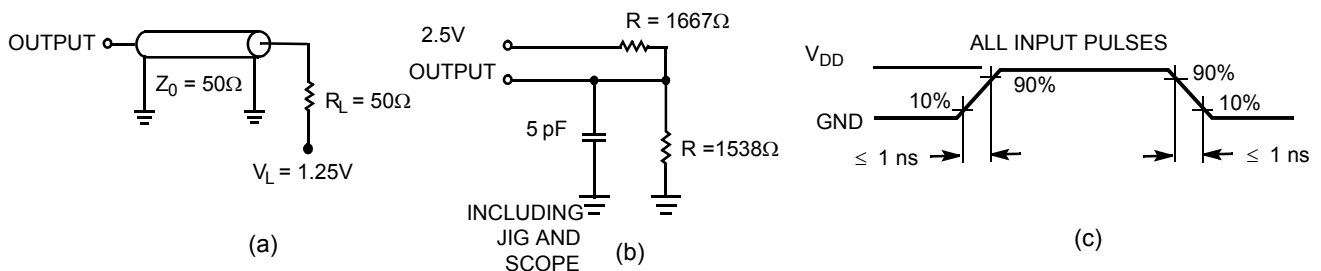
AC Test Loads and Waveforms
3.3V I/O Test Load

2.5V I/O Test Load

Note:

15. Tested initially and after any design or process change that may affect these parameters.

Switching Characteristics Over the Operating Range^[16, 17]

Parameter	Description	225 MHz		200 MHz		166 MHz		Unit
		Min.	Max	Min.	Max	Min.	Max	
t _{POWER}	V _{DD} (Typical) to the First Access ^[18]	1		1		1		ms
Clock								
t _{CYC}	Clock Cycle Time	4.4		5.0		6.0		ns
t _{CH}	Clock HIGH	1.8		2.0		2.4		ns
t _{CL}	Clock LOW	1.8		2.0		2.4		ns
Output Times								
t _{CO}	Data Output Valid after CLK Rise		2.8		3.0		3.5	ns
t _{DOH}	Data Output Hold after CLK Rise	1.25		1.25		1.25		ns
t _{CLZ}	Clock to Low-Z ^[19, 20, 21]	1.25		1.25		1.25		ns
t _{CHZ}	Clock to High-Z ^[19, 20, 21]	1.25	2.8	1.25	3.0	1.25	3.5	ns
t _{OEV}	\overline{OE} LOW to Output Valid		2.8		3.0		3.5	ns
t _{OELZ}	\overline{OE} LOW to Output Low-Z ^[19, 20, 21]	0		0		0		ns
t _{OEHZ}	\overline{OE} HIGH to Output High-Z ^[19, 20, 21]		2.8		3.0		3.5	ns
Set-up Times								
t _{AS}	Address Set-up before CLK Rise	1.4		1.5		1.5		ns
t _{ADS}	\overline{ADSC} , \overline{ADSP} Set-up before CLK Rise	1.4		1.5		1.5		ns
t _{ADVS}	\overline{ADV} Set-up before CLK Rise	1.4		1.5		1.5		ns
t _{WES}	\overline{GW} , \overline{BWE} , \overline{BW}_X Set-up before CLK Rise	1.4		1.5		1.5		ns
t _{DS}	Data Input Set-up before CLK Rise	1.4		1.5		1.5		ns
t _{CES}	Chip Enable Set-Up before CLK Rise	1.4		1.5		1.5		ns
Hold Times								
t _{AH}	Address Hold after CLK Rise	0.4		0.5		0.5		ns
t _{ADH}	\overline{ADSP} , \overline{ADSC} Hold after CLK Rise	0.4		0.5		0.5		ns
t _{ADVH}	\overline{ADV} Hold after CLK Rise	0.4		0.5		0.5		ns
t _{WEH}	\overline{GW} , \overline{BWE} , \overline{BW}_X Hold after CLK Rise	0.4		0.5		0.5		ns
t _{DH}	Data Input Hold after CLK Rise	0.4		0.5		0.5		ns
t _{CEH}	Chip Enable Hold after CLK Rise	0.4		0.5		0.5		ns

Shaded areas contain advance information.

Notes:

16. Timing reference level is 1.5V when V_{DDQ} = 3.3V and is 1.25V when V_{DDQ} = 2.5V.

17. Test conditions shown in (a) of AC Test Loads unless otherwise noted.

18. This part has a voltage regulator internally; t_{POWER} is the time that the power needs to be supplied above V_{DD}(minimum) initially before a Read or Write operation can be initiated.

19. t_{CHZ}, t_{CLZ}, t_{OELZ}, and t_{OEHZ} are specified with AC test conditions shown in part (b) of AC Test Loads. Transition is measured ± 200 mV from steady-state voltage.

20. At any given voltage and temperature, t_{OEHZ} is less than t_{OELZ} and t_{CHZ} is less than t_{CLZ} to eliminate bus contention between SRAMs when sharing the same data bus. These specifications do not imply a bus contention condition, but reflect parameters guaranteed over worst case user conditions. Device is designed to achieve High-Z prior to Low-Z under the same system conditions

21. This parameter is sampled and not 100% tested.

Switching Waveforms

Read Cycle Timing^[22]

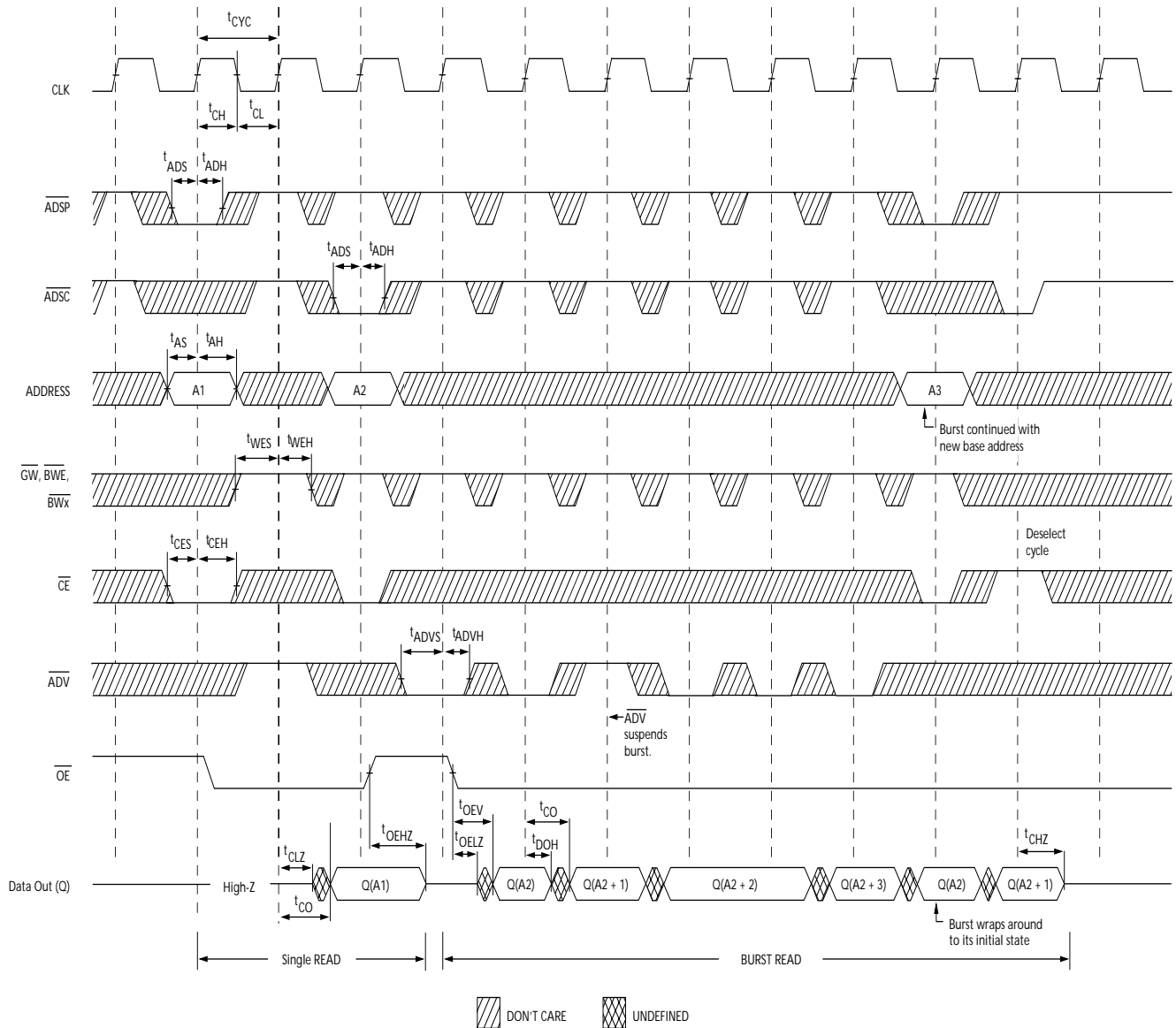

Note:

22. On this diagram, when \overline{CE} is LOW: \overline{CE}_1 is LOW, CE_2 is HIGH and \overline{CE}_3 is LOW. When \overline{CE} is HIGH: \overline{CE}_1 is HIGH or CE_2 is LOW or \overline{CE}_3 is HIGH.

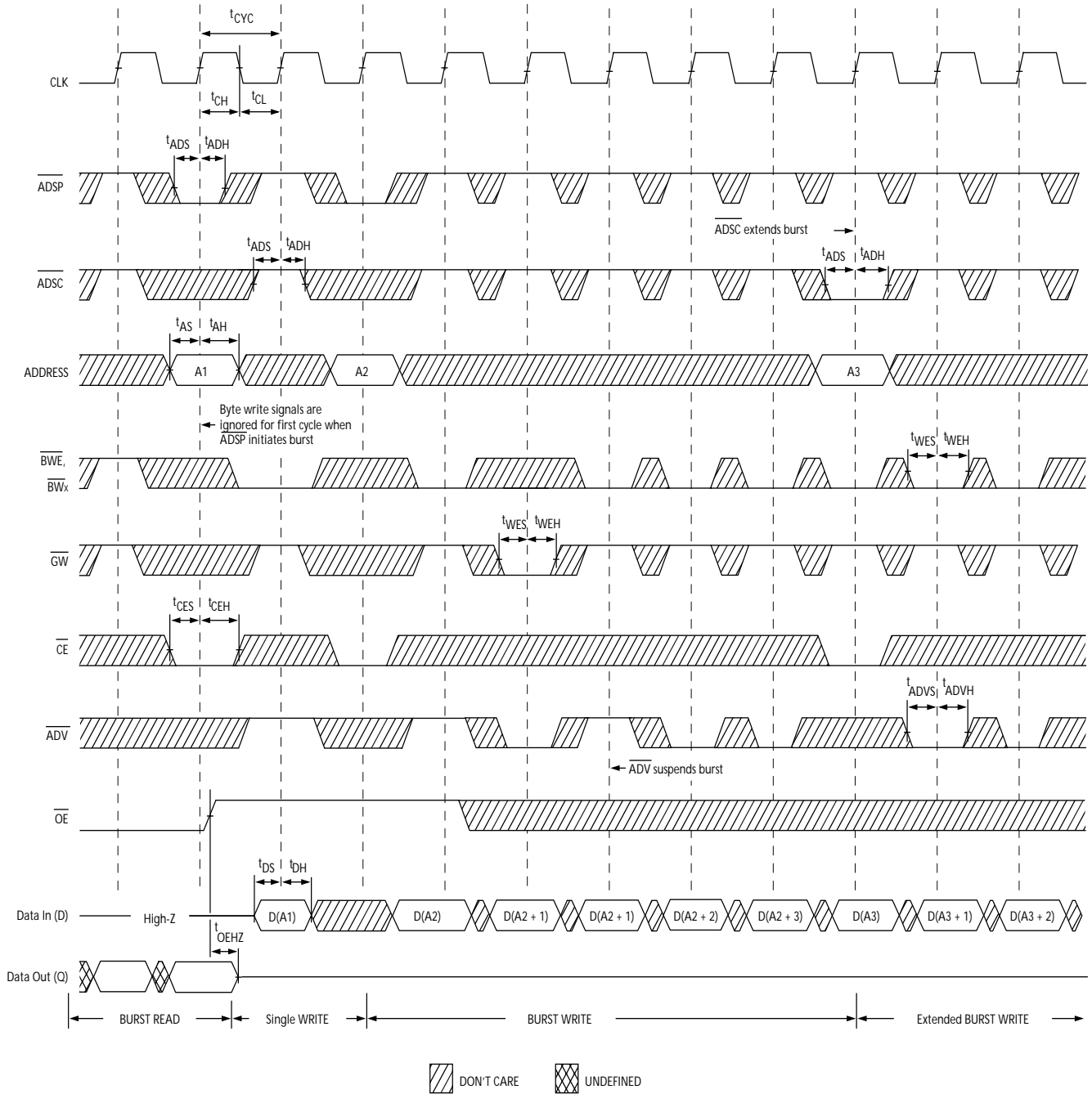
Switching Waveforms(continued)
Write Cycle Timing^[22, 23]

Note:

 23. Full width Write can be initiated by either \overline{GW} LOW; or by \overline{GW} HIGH, \overline{BWE} LOW and \overline{BW}_x LOW.

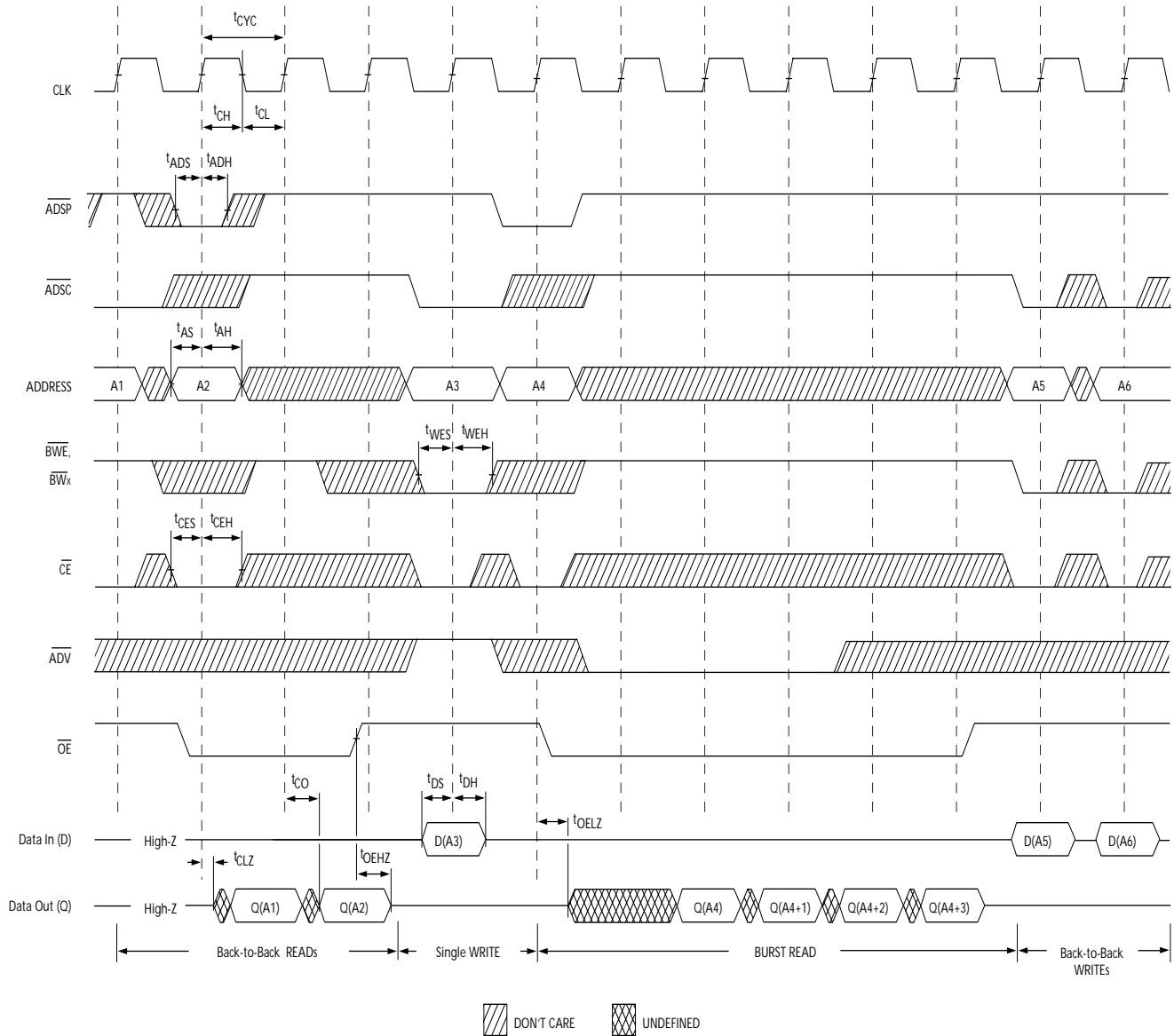
Switching Waveforms(continued)
Read/Write Cycle Timing^[22, 24, 25]



Notes:

- 24. The data bus (Q) remains in high-Z following a Write cycle, unless a new Read access is initiated by \overline{ADSP} or \overline{ADSC} .
- 25. GW is HIGH.

Switching Waveforms(continued)

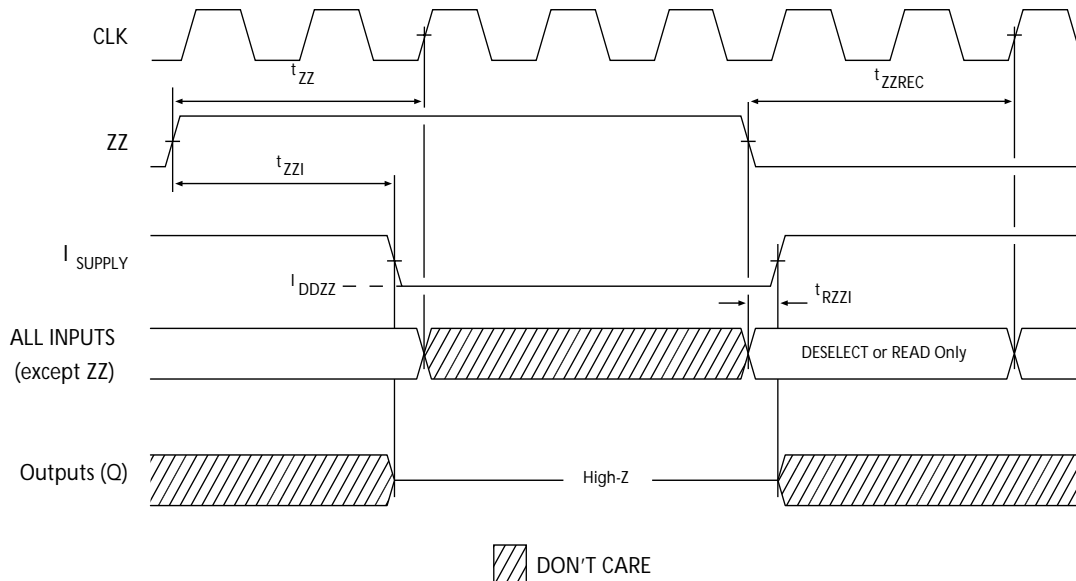
ZZ Mode Timing [26, 27]

Notes:

26. Device must be deselected when entering ZZ mode. See Cycle Descriptions table for all possible signal conditions to deselect the device.
 27. DQs are in High-Z when exiting ZZ sleep mode.

Ordering Information

Speed (MHz)	Ordering Code	Package Name	Part and Package Type	Operating Range
225	CY7C1360B-225AC CY7C1362B-225AC	A101	100-lead Thin Quad Flat Pack (14 x 20 x 1.4mm) 3 Chip Enables	Commercial
	CY7C1360B-225AI CY7C1362B-225AI			Industrial
	CY7C1360B-225AJC CY7C1362B-225AJC	A101	100-lead Thin Quad Flat Pack (14 x 20 x 1.4mm) 2 Chip Enables	Commercial
	CY7C1360B-225AJI CY7C1362B-225AJI			Industrial
	CY7C1360B-225BGC CY7C1362B-225BGC			BG119
	CY7C1360B-225BGI CY7C1362B-225BGI	Industrial		
	CY7C1360B-225BZC CY7C1362B-225BZC	BB165A	165-ball Fine-Pitch Ball Grid Array (13 x 15 x 1.2mm) 3 Chip Enables and JTAG	Commercial
	CY7C1360B-225BZI CY7C1362B-225BZI			Industrial

Shaded areas contain advance information. Please contact your local sales representative for availability of these parts.

Ordering Information (continued)

Speed (MHz)	Ordering Code	Package Name	Part and Package Type	Operating Range		
200	CY7C1360B-200AC CY7C1362B-200AC	A101	100-lead Thin Quad Flat Pack (14 x 20 x 1.4mm) 3 Chip Enables	Commercial		
	CY7C1360B-200AI CY7C1362B-200AI			Industrial		
	CY7C1360B-200AJC CY7C1362B-200AJC	A101	100-lead Thin Quad Flat Pack (14 x 20 x 1.4mm) 2 Chip Enables	Commercial		
	CY7C1360B-200AJI CY7C1362B-200AJI			Industrial		
	CY7C1360B-200BGC CY7C1362B-200BGC			BG119	119-ball (14 x 22 x 2.4 mm) BGA 2 Chip Enables and JTAG	Commercial
	CY7C1360B-200BGI CY7C1362B-200BGI	Industrial				
	CY7C1360B-200BZC CY7C1362B-200BZC	BB165A	165-ball Fine-Pitch Ball Grid Array (13 x 15 x 1.2mm) 3 Chip Enables and JTAG	Commercial		
	CY7C1360B-200BZI CY7C1362B-200BZI			Industrial		
	166	CY7C1360B-166AC CY7C1362B-166AC	A101	100-lead Thin Quad Flat Pack (14 x 20 x 1.4mm) 3 Chip Enables	Commercial	
		CY7C1360B-166AI CY7C1362B-166AI			Industrial	
		CY7C1360B-166AJC CY7C1362B-166AJC			A101	100-lead Thin Quad Flat Pack (14 x 20 x 1.4mm) 2 Chip Enables
CY7C1360B-166AJI CY7C1362B-166AJI		Industrial				
CY7C1360B-166BGC CY7C1362B-166BGC		BG119	119-ball (14 x 22 x 2.4 mm) BGA 2 Chip Enables and JTAG	Commercial		
CY7C1360B-166BGI CY7C1362B-166BGI				Industrial		
CY7C1360B-166BZC CY7C1362B-166BZC		BB165A	165-ball Fine-Pitch Ball Grid Array (13 x 15 x 1.2mm) 3 Chip Enables and JTAG	Commercial		
CY7C1360B-166BZI CY7C1362B-166BZI				Industrial		

Shaded areas contain advance information. Please contact your local sales representative for availability of these parts.

Package Diagrams (continued)

119-Lead PBGA (14 x 22 x 2.4 mm) BG119

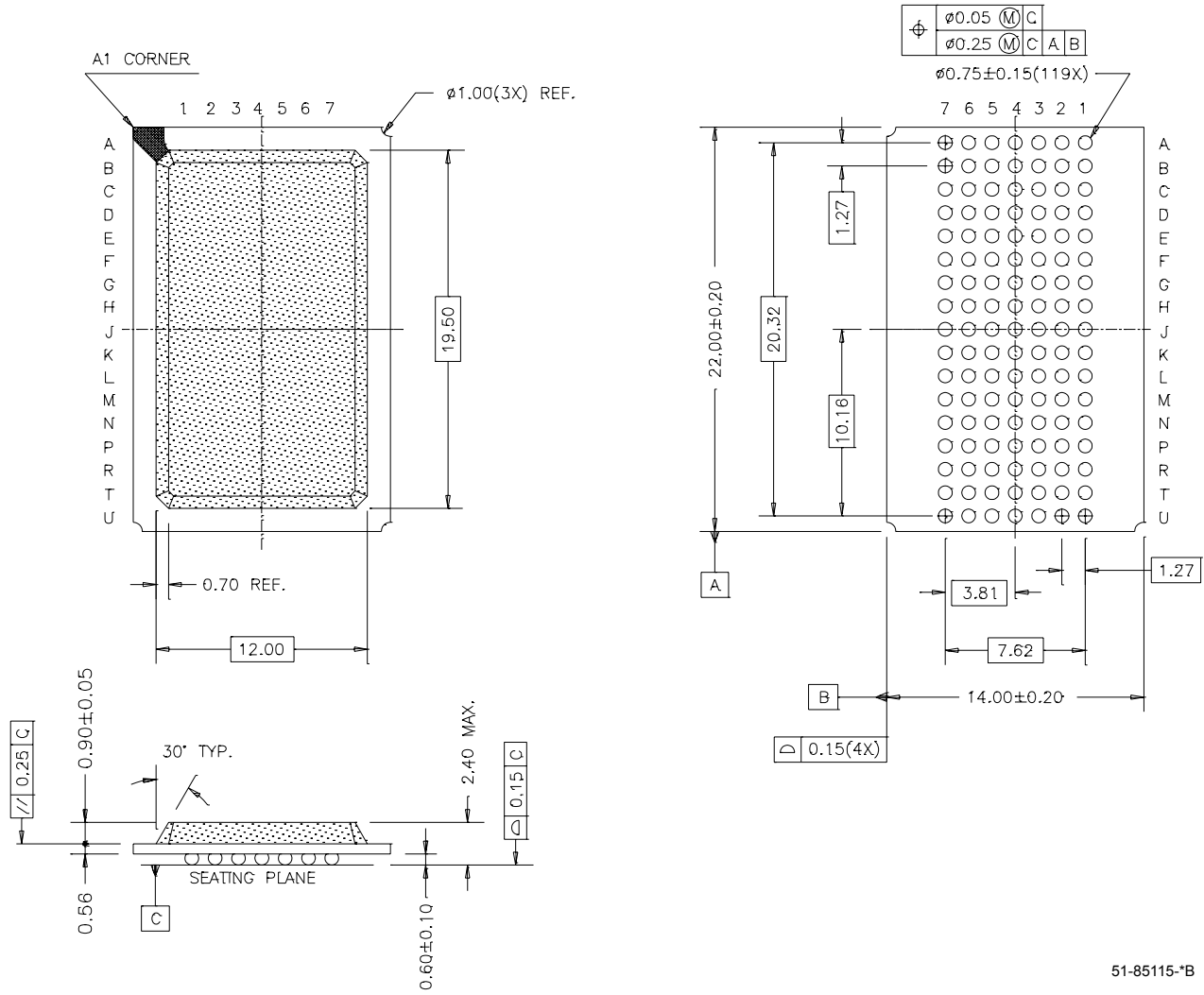

51-85115-B

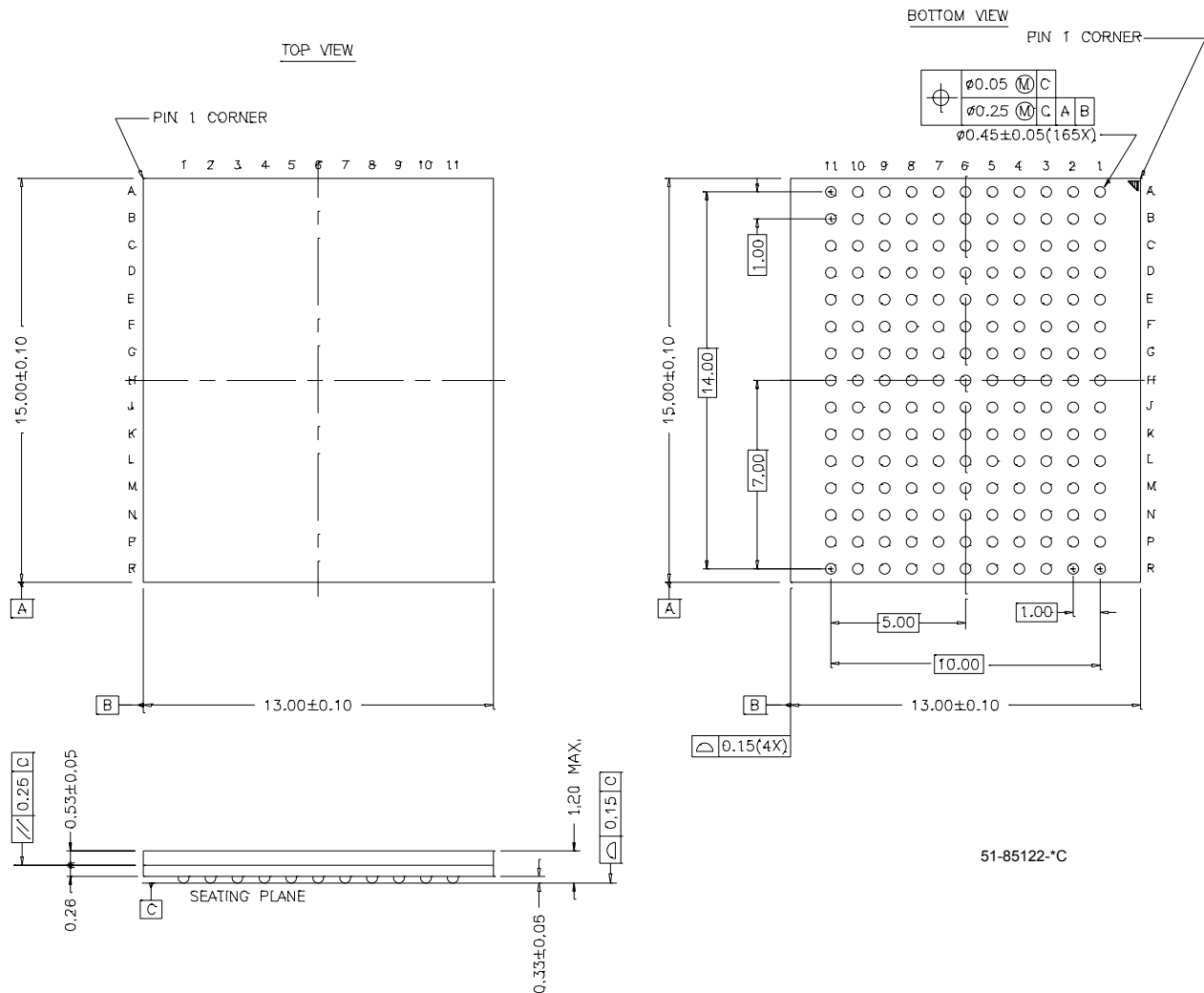
Package Diagrams (continued)
165-Ball FBGA (13 x 15 x 1.2 mm) BB165A

51-85122-*C

i486 is a trademark, and Intel and Pentium are registered trademarks of Intel Corporation. PowerPC is a trademark of IBM Corporation. All product and company names mentioned in this document are the trademarks of their respective holders.

Document History Page

Document Title: CY7C1360B/CY7C1362B 9-Mbit (256K x 36/512K x 18) Pipelined SRAM				
Document #: 38-05291 Rev. *C				
REV.	ECN NO.	Issue Date	Orig. of Change	Description of Change
**	114766	08/08/02	RCS	New Data Sheet
*A	117939	08/20/02	RCS	Added A0 and A1 to 165 fBGA pinout
*B	205060	See ECN	NJY	Final Data Sheet
*C	225181	See ECN	VBL	Update Ordering Info section: shade S,E part numbers