



Features

- Automatic power-down when deselected
- CMOS for optimum speed/power
- High speed
— 20 ns
- Low active power
— 550 mW
- Low standby power
— 110 mW
- TTL-compatible inputs and outputs
- Capable of withstanding greater than 2001V electrostatic discharge

Functional Description

The CY6116A and CY6117A are high-performance CMOS static RAMs organized as 2048 words by 8 bits. Easy memory expansion is provided by an active LOW chip enable (\overline{CE}) and active LOW output enable (\overline{OE}), and three-state drivers. The CY6116A and CY6117A have an automatic power-down feature, reducing the power consumption by 83% when deselected.

Writing to the device is accomplished when the chip enable (\overline{CE}) and write enable (\overline{WE}) inputs are both LOW. Data on the I/O pins (I/O_0 through I/O_7) is written into the memory location specified on the address pins (A_0 through A_{10}).

Reading the device is accomplished by taking chip enable (\overline{CE}) and output enable (\overline{OE}) LOW while write enable (\overline{WE}) remains HIGH. Under these conditions, the contents of the memory location specified on the address pins will appear on the I/O pins.

The I/O pins remain in high-impedance state when chip enable (\overline{CE}) is HIGH or write enable (\overline{WE}) is LOW.

The CY6116A and CY6117A utilize a die coat to insure alpha immunity.

2
SRAMS

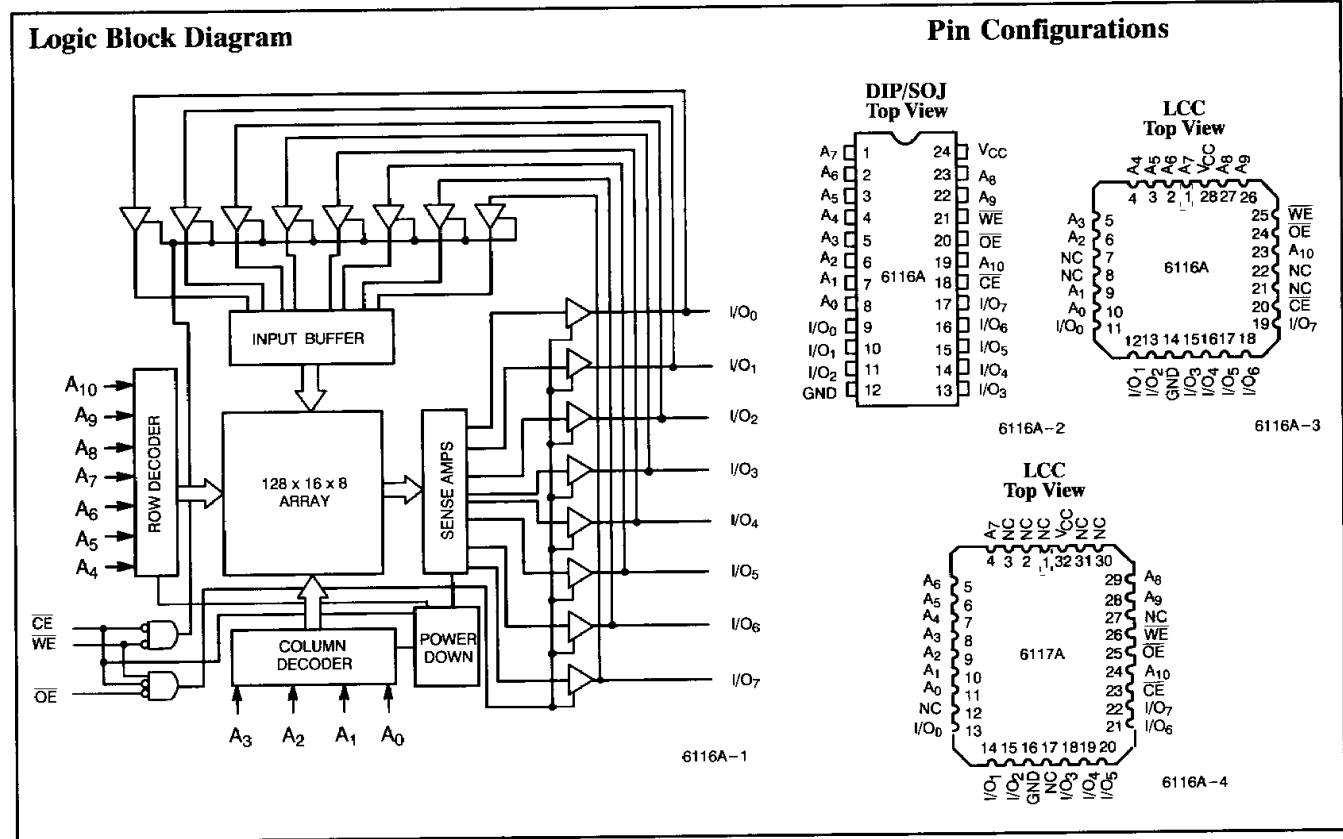

Selection Guide

		6116A-20 6117A-20	6116A-25 6117A-25	6116A-35 6117A-35	6116A-45 6117A-45	6116A-55 6117A-55
Maximum Access Time (ns)		20	25	35	45	55
Maximum Operating Current (mA)	Commercial	100	100	100	100	80
	Military		125	100	100	100
Maximum Standby Current (mA)	Commercial	40/20	20	20	20	20
	Military		40	20	20	20

Maximum Ratings

(Above which the useful life may be impaired. For user guidelines, not tested.)

Storage Temperature	- 65°C to + 150°C
Ambient Temperature with Power Applied	- 55°C to + 125°C
Supply Voltage to Ground Potential (Pin 24 to Pin 12)	- 0.5V to + 7.0V
DC Voltage Applied to Outputs in High Z State	- 0.5V to + 7.0V
DC Input Voltage	- 3.0V to + 7.0V
Output Current into Outputs (Low)	20 mA

Static Discharge Voltage >2001V
(per MIL-STD-883, Method 3015)

Latch-Up Current >200 mA

Operating Range

Range	Ambient Temperature	V _{CC}
Commercial	0°C to + 70°C	5V ± 10%
Military ^[1]	- 55°C to + 125°C	5V ± 10%

Electrical Characteristics Over the Operating Range^[2]

Parameters	Description	Test Conditions	6116A-20 6117A-20		6116A-25, 35, 45 6117A-25, 35, 45		6116A-55 6117A-55		Units	
			Min.	Max.	Min.	Max.	Min.	Max.		
V _{OH}	Output HIGH Voltage	V _{CC} = Min., I _{OH} = - 4.0 mA	2.4		2.4		2.4		V	
V _{OL}	Output LOW Voltage	V _{CC} = Min., I _{OL} = 8.0 mA		0.4		0.4		0.4	V	
V _{IH}	Input HIGH Voltage		2.2	V _{CC}	2.2	V _{CC}	2.2	V _{CC}	V	
V _{IL}	Input LOW Voltage ^[3]		-0.5	0.8	-0.5	0.8	-0.5	0.8	V	
I _{IX}	Input Load Current	GND ≤ V _I ≤ V _{CC}	-10	+10	-10	+10	-10	+10	μA	
I _{OZ}	Output Leakage Current	GND ≤ V _I ≤ V _{CC} , Output Disabled	-10	+10	-10	+10	-10	+10	μA	
I _{OS}	Output Short Circuit Current ^[4]	V _{CC} = Max., V _{OUT} = GND		-300		-300		-300	mA	
I _{CC}	V _{CC} Operating Supply Current	V _{CC} = Max. I _{OUT} = 0 mA f = f _{MAX} = 1/trc	Com'l			100		100	80	mA
			Mil	25			125		100	
				35, 45			100			
I _{SB1}	Automatic CE Power-Down Current - TTL Inputs	Max. V _{CC} , CE ≥ V _{IH} f = f _{MAX}	Com'l			40		20	20	mA
			Mil	25			40		20	
				35, 45, 55			20			
I _{SB2}	Automatic CE Power-Down Current - CMOS Inputs	Max. V _{CC} , CE ≥ V _{IH} - 0.3V, V _{IN} ≥ V _{CC} - 0.3V or V _{IN} ≤ 0.3V, f = 0	Com'l			20		20	20	mA
			Mil					20	20	

Capacitance^[5]

Parameters	Description	Test Conditions	Max.	Units
C _{IN}	Input Capacitance	T _A = 25°C, f = 1 MHz, V _{CC} = 5.0V	10	pF
C _{OUT}	Output Capacitance		10	pF

Notes:

1. T_A is the "instant on" case temperature.
2. See the last page of this specification for Group A subgroup testing information.
3. V_{IL} (min.) = -3.0V for pulse durations less than 30 ns.
4. Not more than 1 output should be shorted at one time. Duration of the short circuit should not exceed 30 seconds.
5. Tested initially and after any design or process changes that may affect these parameters.

AC Test Loads and Waveforms

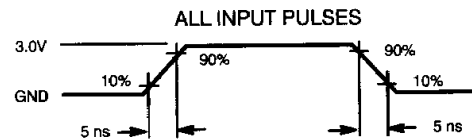
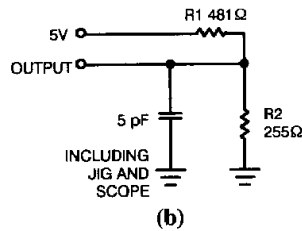
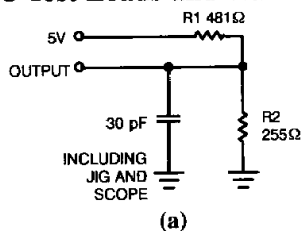

Equivalent to: THEVENIN EQUIVALENT
 167Ω
 OUTPUT \rightarrow 1.73V

6116A-5

6116A-6

Switching Characteristics Over the Operating Range^[2, 6]

Parameters	Description	6116A-20		6116A-25		6116A-35		6116A-45		6116A-55		Units
		Min.	Max.	Min.	Max.	Min.	Max.	Min.	Max.	Min.	Max.	
READ CYCLE												
t_{RC}	Read Cycle Time	20		25		35		45		55		ns
t_{AA}	Address to Data Valid		20		25		35		45		55	ns
t_{OHA}	Data Hold from Address Change	5		5		5		5		5		ns
t_{ACE}	\overline{CE} LOW to Data Valid		20		25		35		45		55	ns
t_{DOE}	\overline{OE} LOW to Data Valid		10		12		15		20		25	ns
t_{LZOE}	\overline{OE} LOW to Low Z	3		3		3		3		3		ns
t_{HZOE}	\overline{OE} HIGH to High Z ^[7]		8		10		12		15		20	ns
t_{LZCE}	\overline{CE} LOW to Low Z ^[8]	5		5		5		5		5		ns
t_{HZCE}	\overline{CE} HIGH to High Z ^[7, 8]		8		10		15		15		20	ns
t_{PU}	\overline{CE} LOW to Power-Up	0		0		0		0		0		ns
t_{PD}	\overline{CE} HIGH to Power-Down		20		20		20		25		25	ns
WRITE CYCLE^[9]												
t_{WC}	Write Cycle Time	20		20		25		40		50		ns
t_{SCE}	\overline{CE} LOW to Write End	15		20		25		30		40		ns
t_{AW}	Address Set-Up to Write End	15		20		25		30		40		ns
t_{HA}	Address Hold from Write End	0		0		0		0		0		ns
t_{SA}	Address Set-Up to Write Start	0		0		0		0		0		ns
t_{PWE}	\overline{WE} Pulse Width	15		15		20		20		25		ns
t_{SD}	Data Set-Up to Write End	10		10		15		15		25		ns
t_{HD}	Data Hold from Write End	0		0		0		0		0		ns
t_{HZWE}	\overline{WE} LOW to High Z		7		7		10		15		20	ns
t_{LZWE}	\overline{WE} HIGH to Low Z	5		5		5		5		5		ns

Notes:

- Test conditions assume signal transition time of 5 ns or less, timing reference levels of 1.5V, input pulse levels of 0 to 3.0V, and output loading of the specified I_{OL}/I_{OH} and 30-pF load capacitance.
- t_{HZOE} , t_{HZCE} , and t_{HZWE} are specified with $C_L = 5$ pF as in part (b) of AC Test Loads. Transition is measured ± 500 mV from steady state voltage.
- At any given temperature and voltage condition, t_{HZCE} is less than t_{LZCE} for any given device.
- The internal write time of the memory is defined by the overlap of \overline{CE} LOW and \overline{WE} LOW. Both signals must be LOW to initiate a write and either signal can terminate a write by going HIGH. The data input set-up and hold timing should be referenced to the rising edge of the signal that terminates the write.
- \overline{WE} is HIGH for read cycle.
- Device is continuously selected. \overline{OE} , $\overline{CE} = V_{IL}$.
- Address valid prior to or coincident with \overline{CE} transition LOW.
- Data I/O pins enter high-impedance state, as shown, when \overline{OE} is held LOW during write.
- If \overline{CE} goes HIGH simultaneously with \overline{WE} HIGH, the output remains in a high-impedance state.

Switching Waveforms

Read Cycle No. 1^[10, 11]

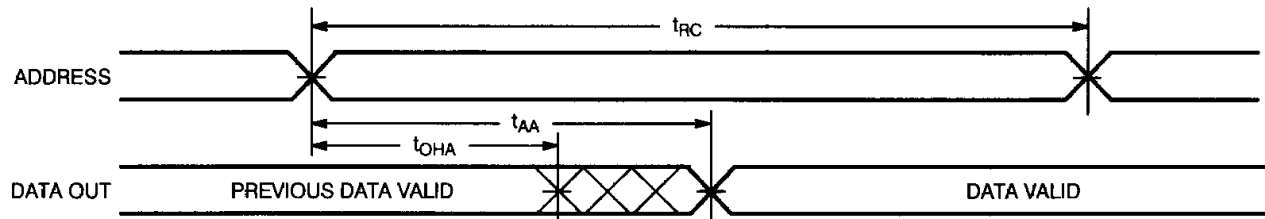

6116A-7

Read Cycle No. 2^[10, 12]

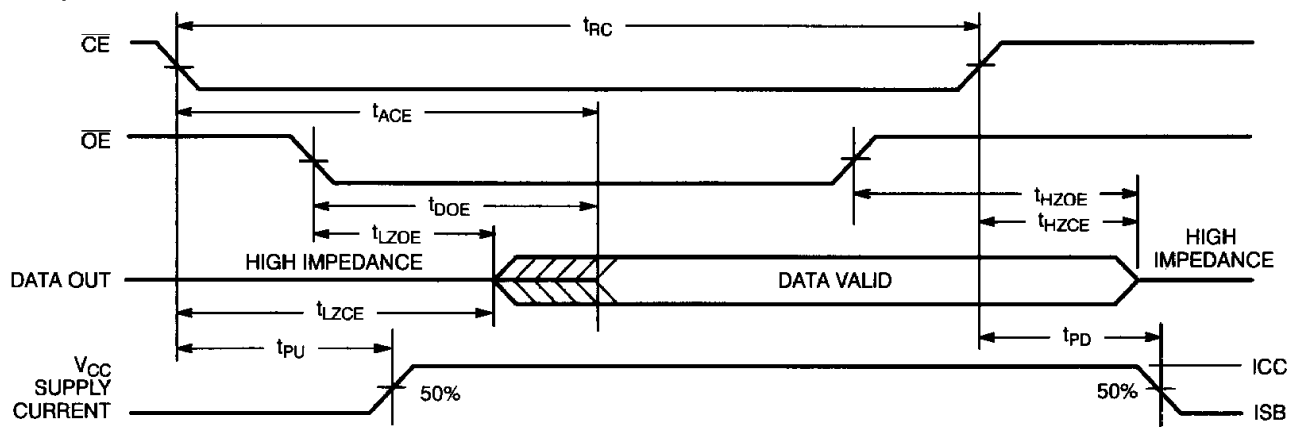

6116A-8

Write Cycle No. 1 (\overline{WE} Controlled)^[9, 13]

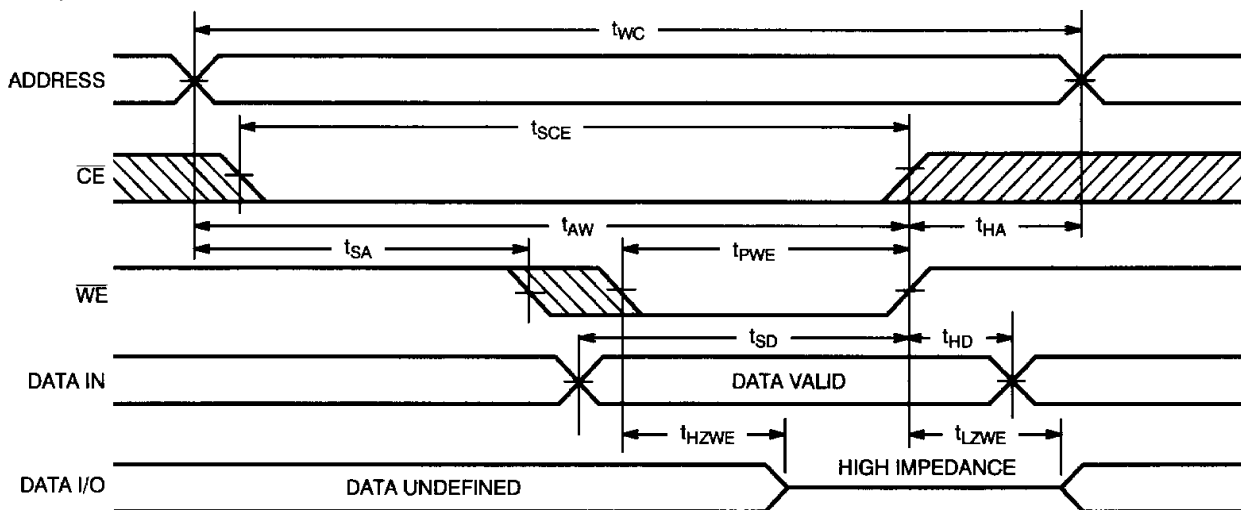

6116A-9

Switching Waveforms (continued)

Write Cycle No. 2 (\overline{CE} Controlled)^[9, 13, 14]

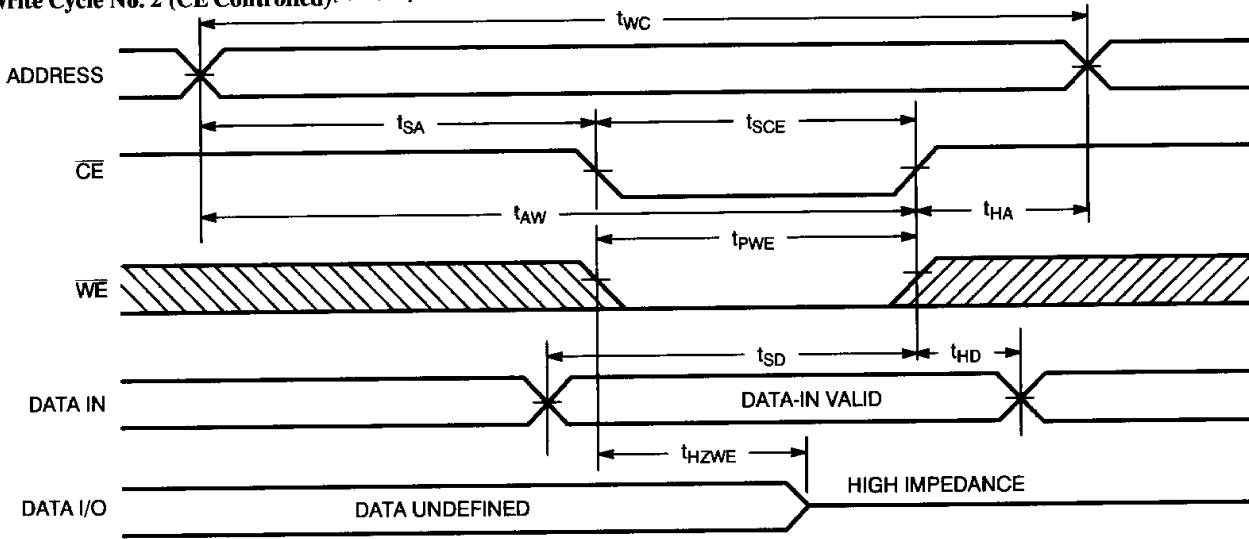

6116A-10

2
SRAMS

Typical DC and AC Characteristics

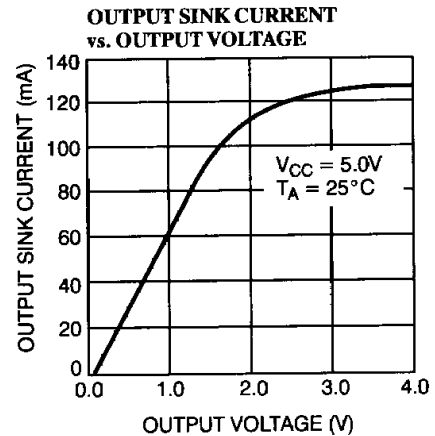
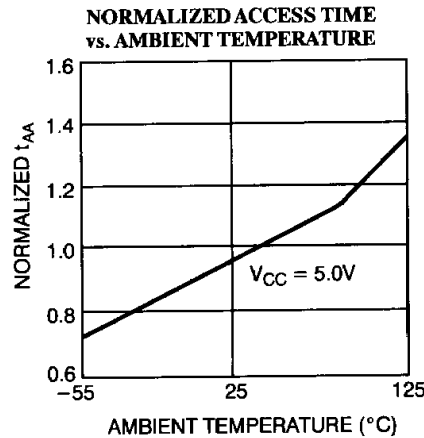
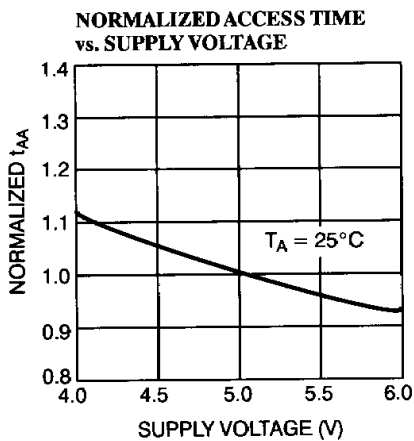
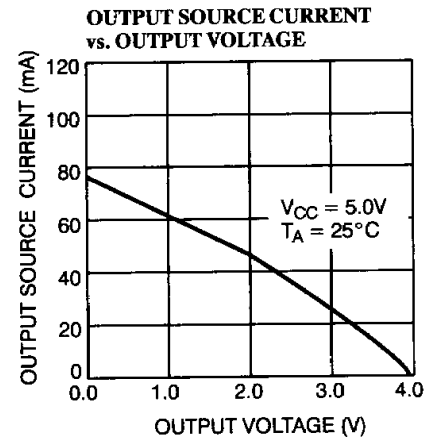
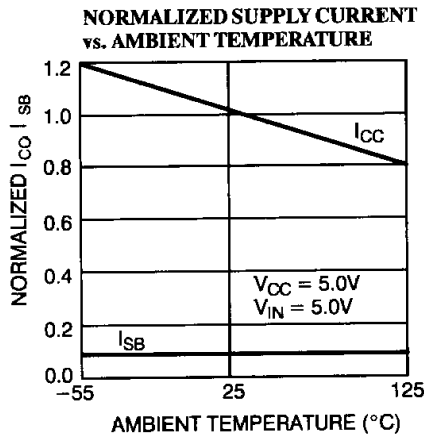
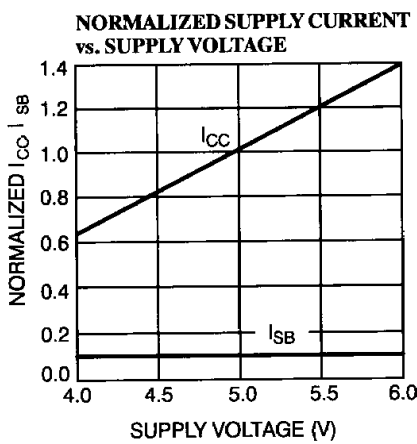

Typical DC and AC Characteristics (continued)

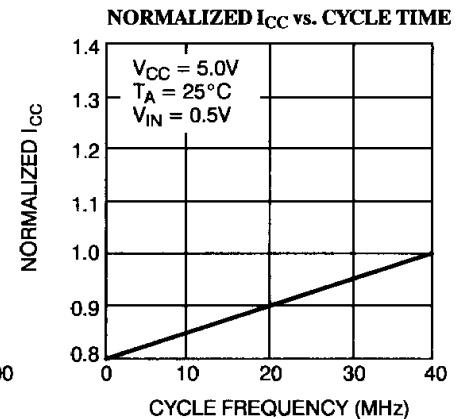
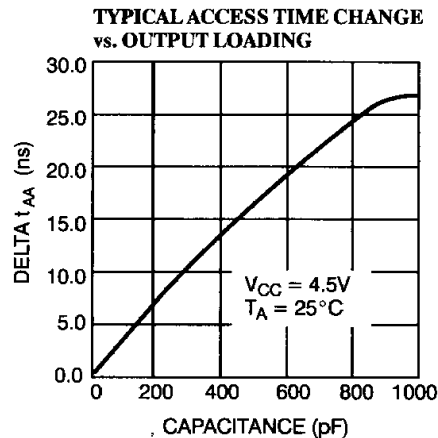
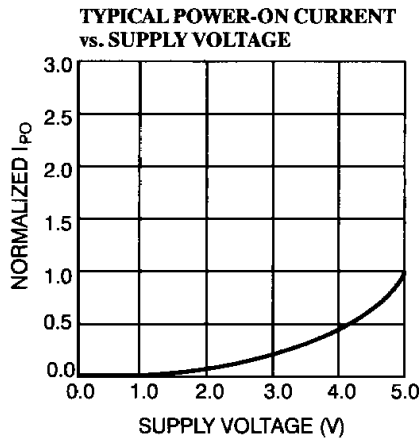

Ordering Information

Speed (ns)	Ordering Code	Package Type	Operating Range
20	CY6116A-20PC	P11	Commercial
	CY6116A-20DC	D12	
25	CY6116A-25PC	P11	Commercial
	CY6116A-25DC	D12	
	CY6116A-25LC	L64	
	CY6116A-25DMB	D12	Military
	CY6116A-25LMB	L64	
35	CY6116A-35PC	P11	Commercial
	CY6116A-35DC	D12	
	CY6116A-35LC	L64	
	CY6116A-35DMB	D12	Military
	CY6116A-35LMB	L64	
45	CY6116A-45PC	P11	Commercial
	CY6116A-45DC	D12	
	CY6116A-45LC	L64	
	CY6116A-45DMB	D12	Military
	CY6116A-45LMB	L64	
55	CY6116A-55PC	P11	Commercial
	CY6116A-55DC	D12	
	CY6116A-55LC	L64	
	CY6116A-55DMB	D12	Military
	CY6116A-55LMB	L64	

Speed (ns)	Ordering Code	Package Type	Operating Range
25	CY6117A-25LMB	L55	Military
35	CY6117A-35LMB	L55	Military
45	CY6117A-45LMB	L55	Military
55	CY6117A-55LMB	L55	Military

MILITARY SPECIFICATIONS
Group A Subgroup Testing

DC Characteristics

Parameters	Subgroups
V _{OH}	1, 2, 3
V _{OL}	1, 2, 3
V _{IH}	1, 2, 3
V _{IL Max.}	1, 2, 3
I _{IX}	1, 2, 3
I _{OZ}	1, 2, 3
I _{CC}	1, 2, 3
I _{SB}	1, 2, 3

Switching Characteristics

Parameters	Subgroups
READ CYCLE	
t _{RC}	7, 8, 9, 10, 11
t _{AA}	7, 8, 9, 10, 11
t _{OHA}	7, 8, 9, 10, 11
t _{ACE}	7, 8, 9, 10, 11
t _{DOE}	7, 8, 9, 10, 11
WRITE CYCLE	
t _{WC}	7, 8, 9, 10, 11
t _{SCE}	7, 8, 9, 10, 11
t _{AW}	7, 8, 9, 10, 11
t _{HA}	7, 8, 9, 10, 11
t _{SA}	7, 8, 9, 10, 11
t _{PWE}	7, 8, 9, 10, 11
t _{SD}	7, 8, 9, 10, 11
t _{HD}	7, 8, 9, 10, 11

Document #: 38-00105-A