

LH5116/H

CMOS 16K (2K × 8) Static RAM

FEATURES

- 2,048 × 8 bit organization
- Access time: 100 ns (MAX.)
- Power consumption:
 - Operating: 220 mW (MAX.)
 - Standby: 5.5 μW (MAX.)
- Single +5 V power supply
- Fully-static operation
- TTL compatible I/O
- Three-state outputs
- Wide temperature range available
 - LH5116H: -40 to +85°C
- Packages:
 - 24-pin, 600-mil DIP
 - 24-pin, 300-mil SK-DIP
 - 24-pin, 450-mil SOP

DESCRIPTION

The LH5116/H are static RAMs organized as 2,048 × 8 bits. It is fabricated using silicon-gate CMOS process technology. It features high speed access in read mode using output enable (t_{OE}).

PIN CONNECTIONS

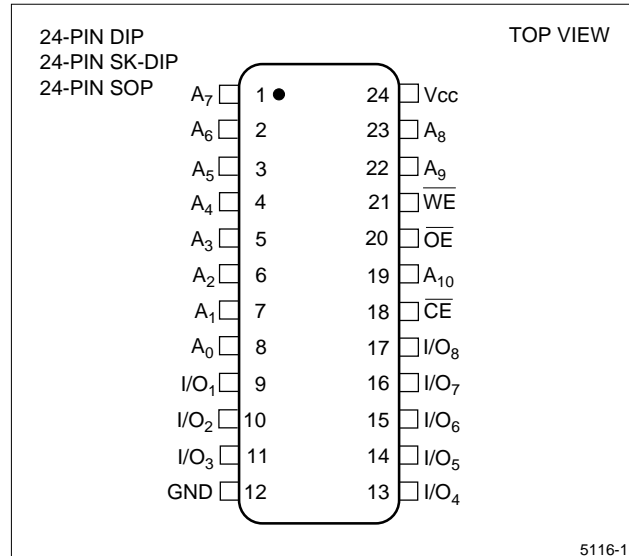

Figure 1. Pin Connections for DIP, SK-DIP, and SOP Packages

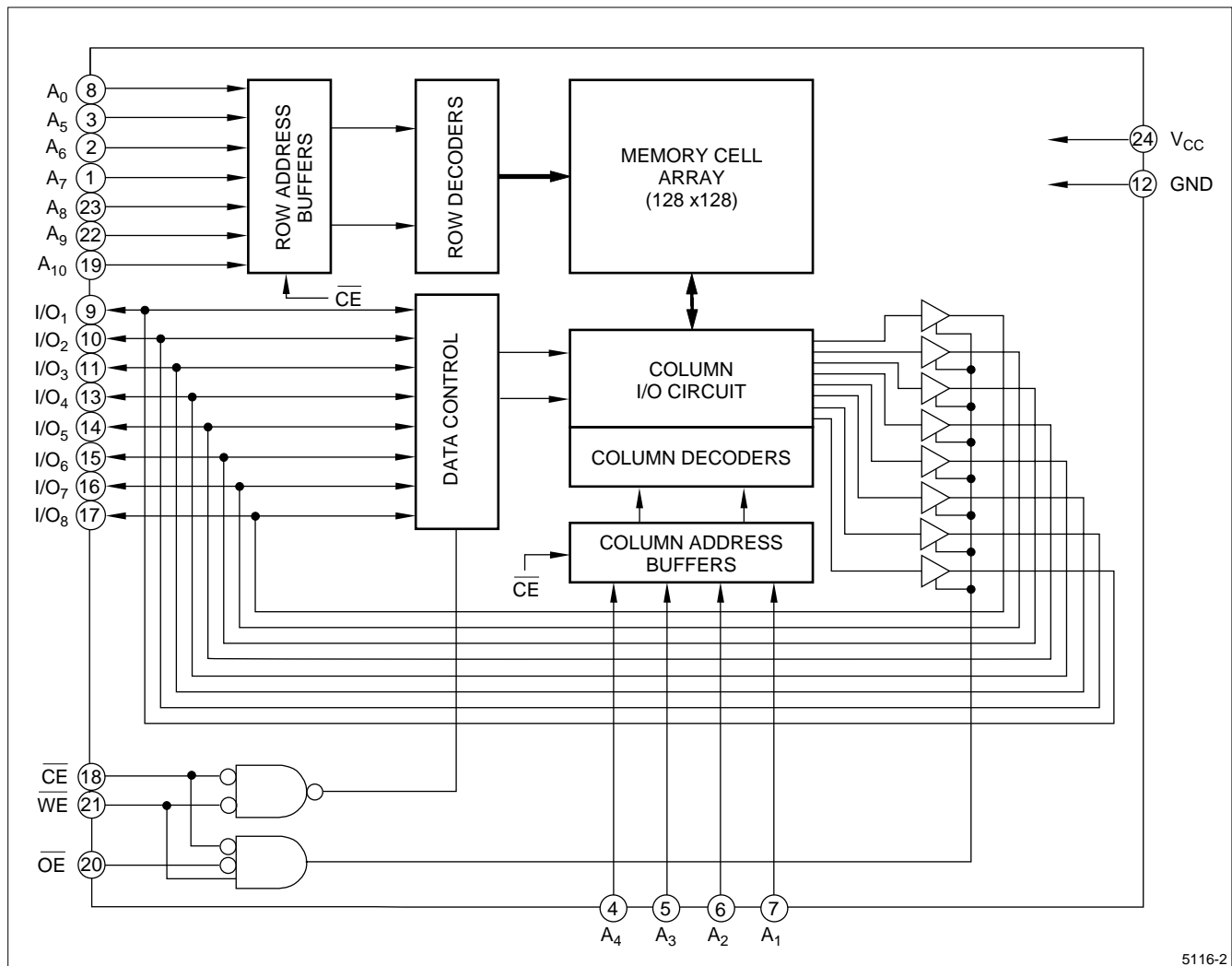

Figure 2. LH5116/H Block Diagram

PIN DESCRIPTION

SIGNAL	PIN NAME
A ₀ - A ₁₀	Address input
CE	Chip Enable input
OE	Output Enable input
WE	Write Enable input

SIGNAL	PIN NAME
I/O ₁ - I/O ₈	Data input/output
V _{CC}	Power supply
GND	Ground

TRUTH TABLE

CE	OE	WE	MODE	I/O ₁ - I/O ₈	SUPPLY CURRENT	NOTE
L	X	L	Write	D _{IN}	Operating (I _{CC})	1
L	L	H	Read	D _{OUT}	Operating (I _{CC})	
H	X	X	Deselect	High-Z	Standby (I _{SB})	1
L	H	X	Outputs disable	High-Z	Operating (I _{CC})	1

NOTE:

- X = H or L

ABSOLUTE MAXIMUM RATINGS

PARAMETER	SYMBOL	RATING	UNIT	NOTE
Supply voltage	V _{CC}	-0.3 to +7.0	V	1
Input voltage	V _{IN}	-0.3 to V _{CC} + 0.3	V	1
Operating temperature	T _{opr}	0 to +70	°C	2
		-40 to +85		3
Storage temperature	T _{stg}	-55 to +150	°C	

NOTES:

1. The maximum applicable voltage on any pin with respect to GND.
2. Applied to the LH5116/D/NA
3. Applied to the LH5116H/HD/HN

RECOMMENDED OPERATING CONDITIONS ¹

PARAMETER	SYMBOL	MIN.	TYP.	MAX.	UNIT
Supply voltage	V _{CC}	4.5	5.0	5.5	V
Input voltage	V _{IH}	2.2		V _{CC} + 0.3	V
	V _{IL}	-0.3		0.8	V

NOTE:

1. T_A = 0 to 70°C (LH5116/D/NA), T_A = -40 to +85°C (LH5116H/HD/HN)

DC CHARACTERISTICS ¹ (V_{CC} = 5 V ±10%)

PARAMETER	SYMBOL	CONDITIONS	MIN.	TYP.	MAX.	UNIT	NOTE
Output 'LOW' voltage	V _{OL}	I _{OL} = 2.1 mA			0.4	V	
Output 'HIGH' voltage	V _{OH}	I _{OH} = -1.0 mA	2.4			V	
Input leakage current	I _{LI}	V _{IN} = 0 V to V _{CC}	-1.0		1.0	μA	
Output leakage current	I _{LO}	CE = V _{IH} , V _{I/O} = 0 V to V _{CC}	-1.0		1.0	μA	
Operating current	I _{CC1}	Outputs open (OE = V _{CC})		25	30	mA	2
	I _{CC2}	Outputs open (OE = V _{IH})		30	40	mA	3
Standby current	I _{SB}	CE ≥ V _{CC} - 0.2 V All other input pins = 0 V to V _{CC}			1.0	μA	4
					0.2		

NOTES:

1. T_A = 0 to 70°C (LH5116/D/NA), T_A = -40 to +85°C (LH5116H/HD/HN)
2. CE = 0 V; all other input pins = 0 V to V_{CC}
3. CE = V_{IL}; all other input pins = V_{IL} to V_{IH}
4. T_A = 25°C

AC CHARACTERISTICS ¹**(1) READ CYCLE (V_{CC} = 5 V ±10%)**

PARAMETER	SYMBOL	MIN.	TYP.	MAX.	UNIT	NOTE
Read cycle time	t _{RC}	100			ns	
Address access time	t _{AA}			100	ns	
Chip enable access time	t _{ACE}			100	ns	
Chip enable Low to output in Low-Z	t _{CLZ}	10			ns	2
Output enable access time	t _{OE}			40	ns	
Output enable Low to output in Low-Z	t _{OLZ}	10			ns	2
Chip disable to output in High-Z	t _{CHZ}	0		40	ns	2
Output disable to output in High-Z	t _{OHZ}	0		40	ns	2
Output hold time	t _{OH}	10			ns	

NOTES:

1. T_A = 0 to 70°C (LH5116/NA/D), T_A = -40 to 85°C (LH5116H/HD/HN).
2. Active output to high-impedance and high-impedance to output active tests specified for a ±200 mV transition from steady state levels into the test load.

(2) WRITE CYCLE ¹ ($V_{CC} = 5\text{ V} \pm 10\%$)

PARAMETER	SYMBOL	MIN.	TYP.	MAX.	UNIT	NOTE
Write cycle time	t_{WC}	100			ns	
Chip enable to end of write	t_{CW}	80			ns	
Address valid time	t_{AW}	80			ns	
Address setup time	t_{AS}	0			ns	
Write pulse width	t_{WP}	60			ns	
Write recovery time	t_{WR}	10			ns	
Output active from end of write	t_{OW}	10			ns	2
WE Low to output in High-Z	t_{WHZ}	0		30	ns	2
Data valid to end of write	t_{DW}	30			ns	
Data hold time	t_{DH}	10			ns	
Output enable to output in High-Z	t_{OHZ}	0		40	ns	2
Output active from end of write	t_{OW}	10			ns	2

NOTES:

- $T_A = 0$ to $+70^\circ\text{C}$ (LH5116/D/NA), $T_A = -40$ to $+85^\circ\text{C}$ (LH5116H/HD/HN)
- Active output to high-impedance and high-impedance to output active tests specified for a ± 200 mV transition from steady state levels into the test load.

AC TEST CONDITIONS

PARAMETER	MODE	NOTE
Input voltage amplitude	0.8 V to 2.2 V	
Input rise/fall time	10 ns	
Timing reference level	1.5 V	
Output load condition	1TTL + C_L (100 pF)	1

NOTE:

- Includes scope and jig capacitance.

DATA RETENTION CHARACTERISTICS ¹

PARAMETER	SYMBOL	CONDITIONS	MIN.	TYP.	MAX.	UNIT	NOTE
Data retention voltage	V_{CCDR}	$CE \geq V_{CCRC} - 0.2\text{ V}$	2.0		5.5	V	
Data retention current	I_{CCDR}	$CE \geq V_{CCDR} - 0.2\text{ V}$, $V_{CCDR} = 2.0\text{ V}$			1.0 0.2	μA	2
Chip disable to data retention	t_{CDR}		0			ns	
Recovery time	t_R		t_{RC}			ns	3

NOTES:

- $T_A = 0$ to $+70^\circ\text{C}$ (LH5116/D/NA), $T_A = -40$ to $+85^\circ\text{C}$ (LH5116H/HD/HN)
- $T_A = 25^\circ\text{C}$
- t_{RC} = Read cycle time

CAPACITANCE ¹ ($f = 1\text{ MHz}$, $T_A = 25^\circ\text{C}$)

PARAMETER	SYMBOL	CONDITIONS	MIN.	TYP.	MAX.	UNIT
Input capacitance	C_{IN}	$V_{IN} = 0\text{ V}$			7	pF
Input/output capacitance	$C_{I/O}$	$V_{I/O} = 0\text{ V}$			10	pF

NOTE:

- This parameter is sampled and not production tested.

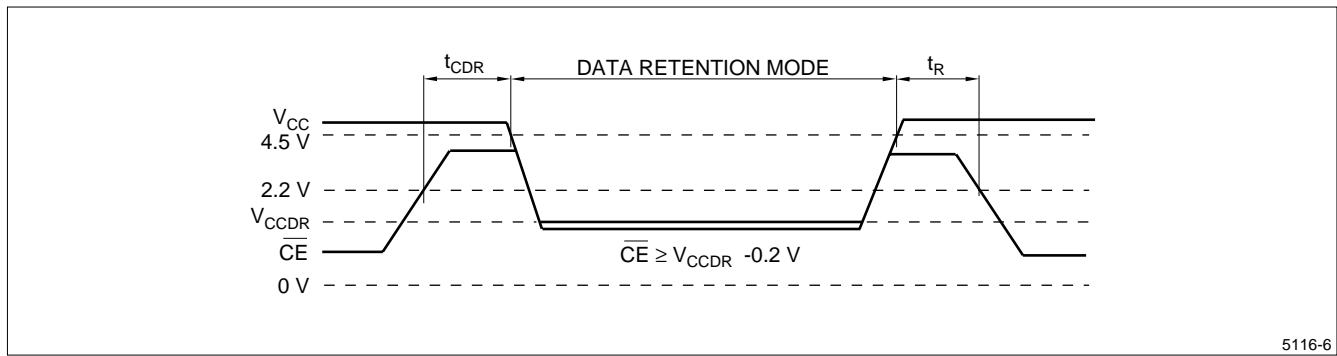

Figure 3. Low Voltage Data Retention

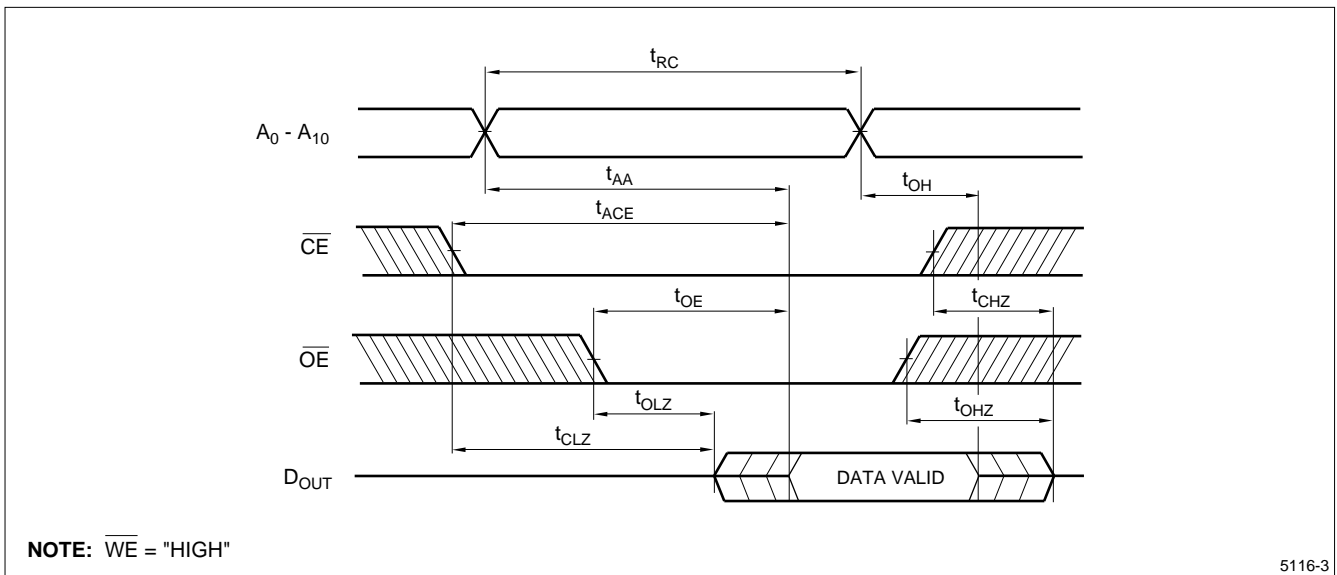
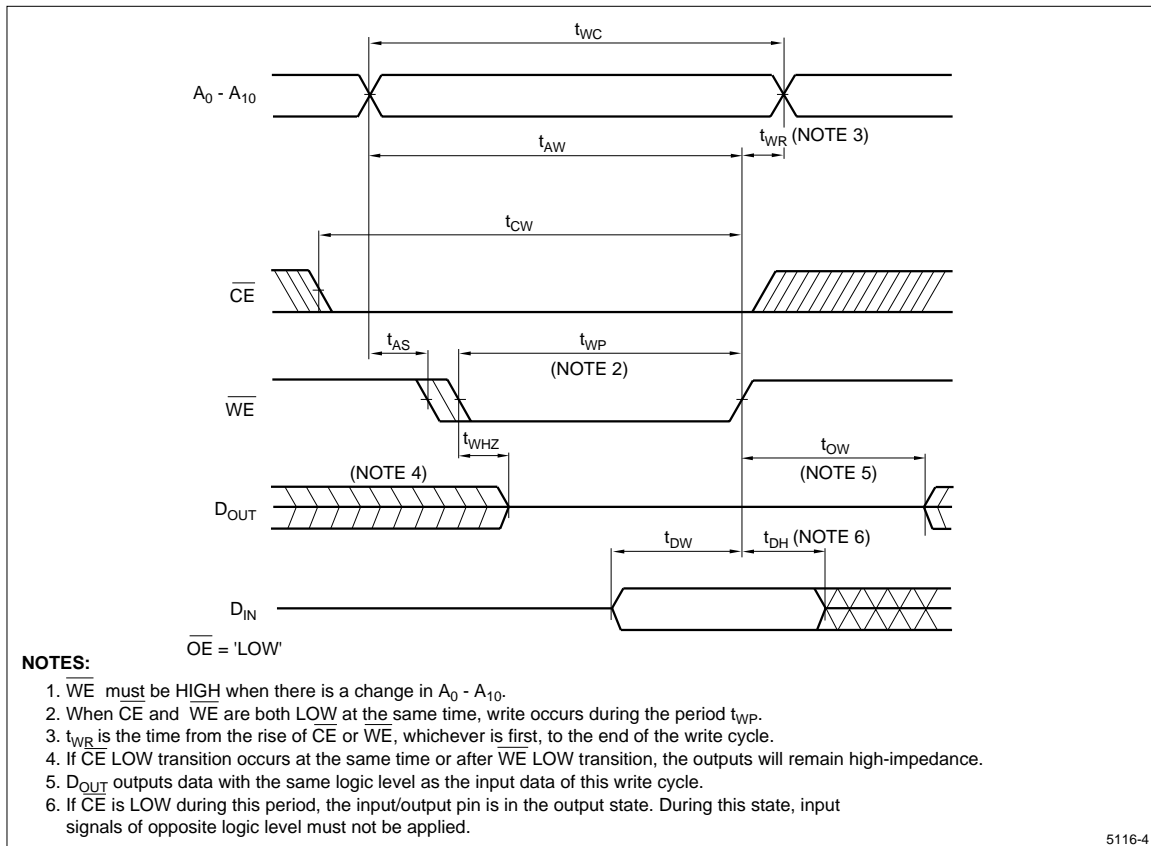
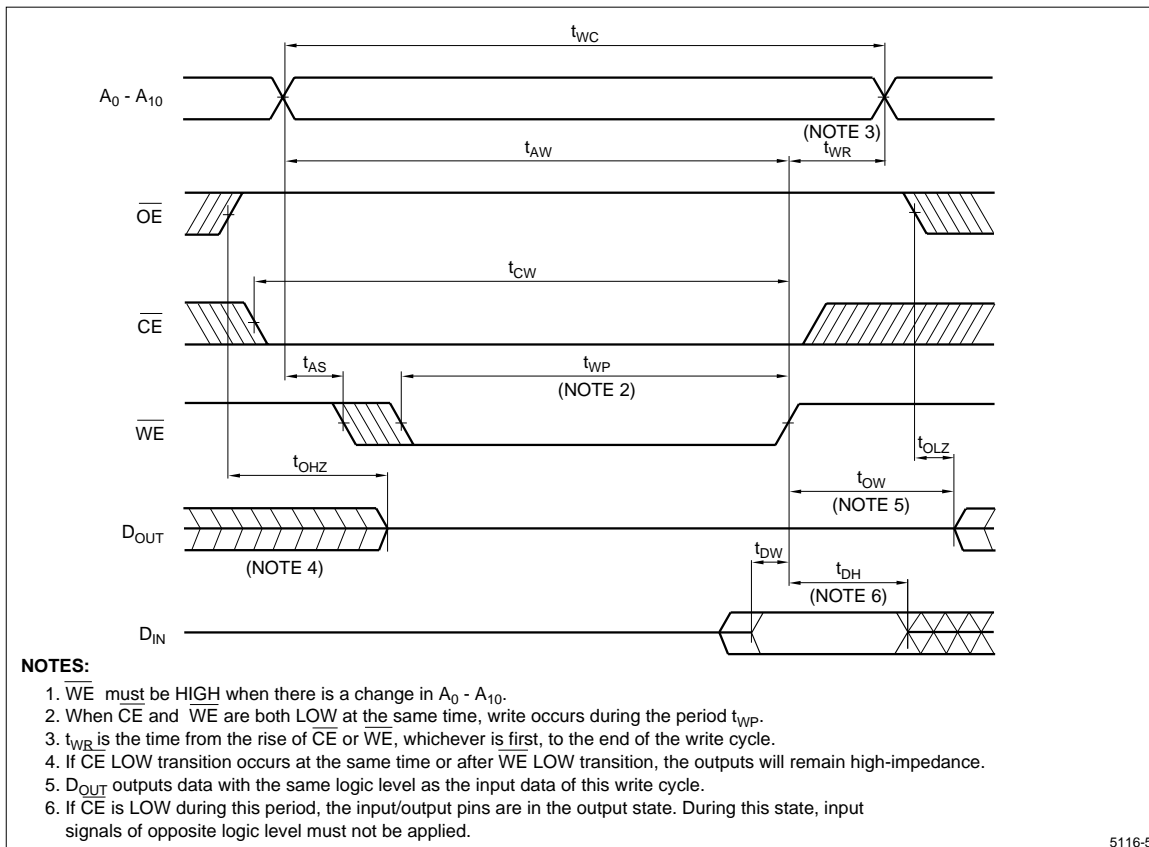

Figure 4. Read Cycle



5116-4

Figure 5. Write Cycle 1



5116-5

Figure 6. Write Cycle 2

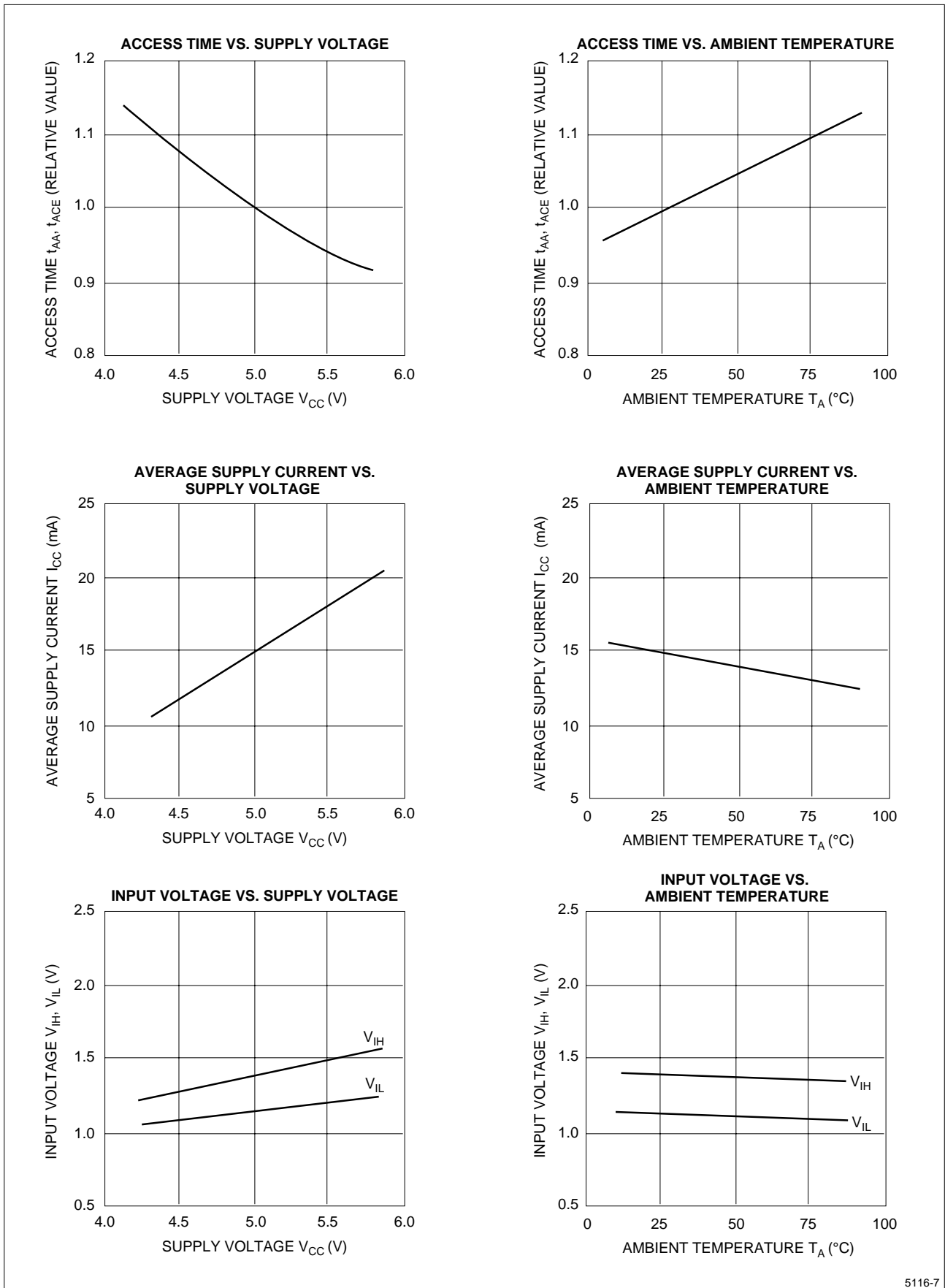

5116-7

Figure 7. Electrical Characteristic Curves
 ($V_{CC} = 5\text{ V}$, $T_A = 25^\circ\text{C}$ unless otherwise specified)

PACKAGE DIAGRAMS

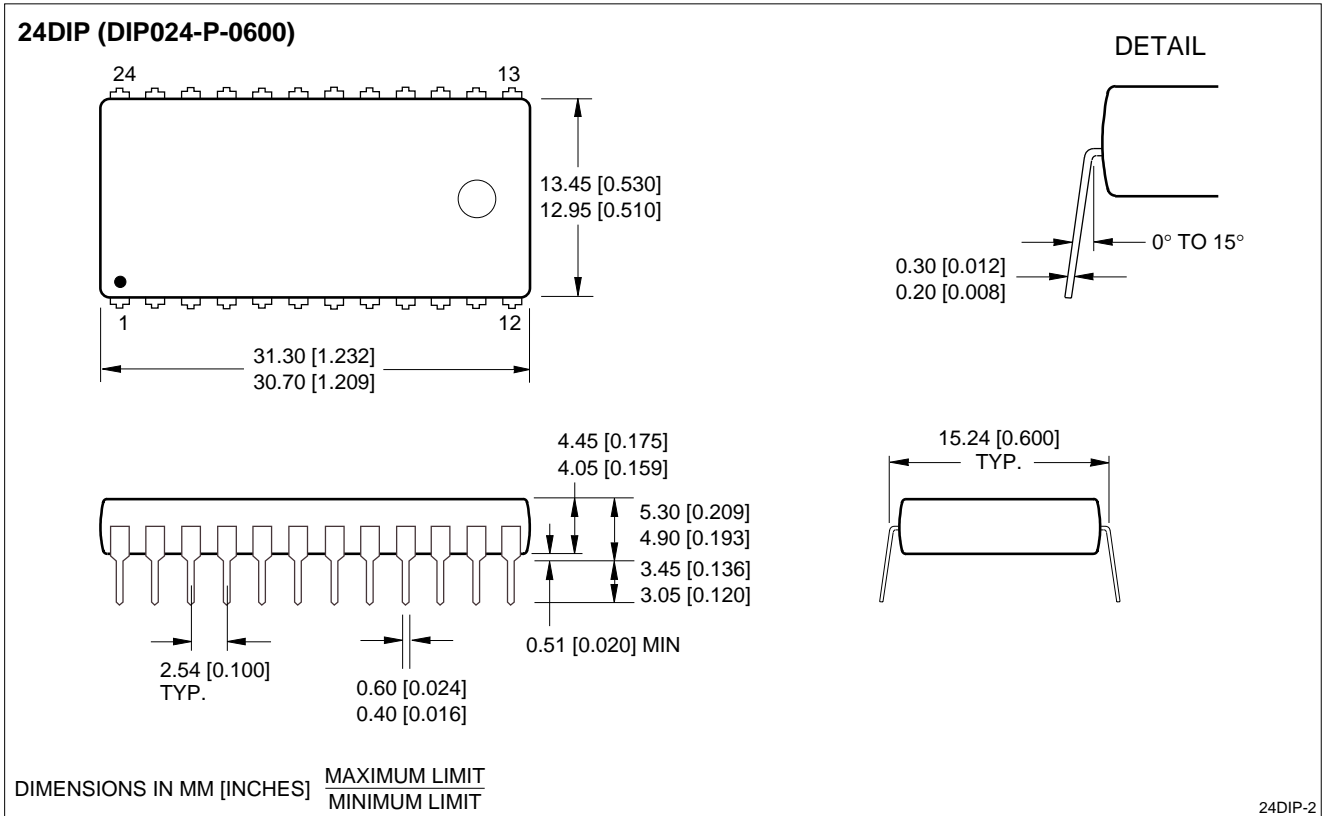

24-pin, 600-mil DIP

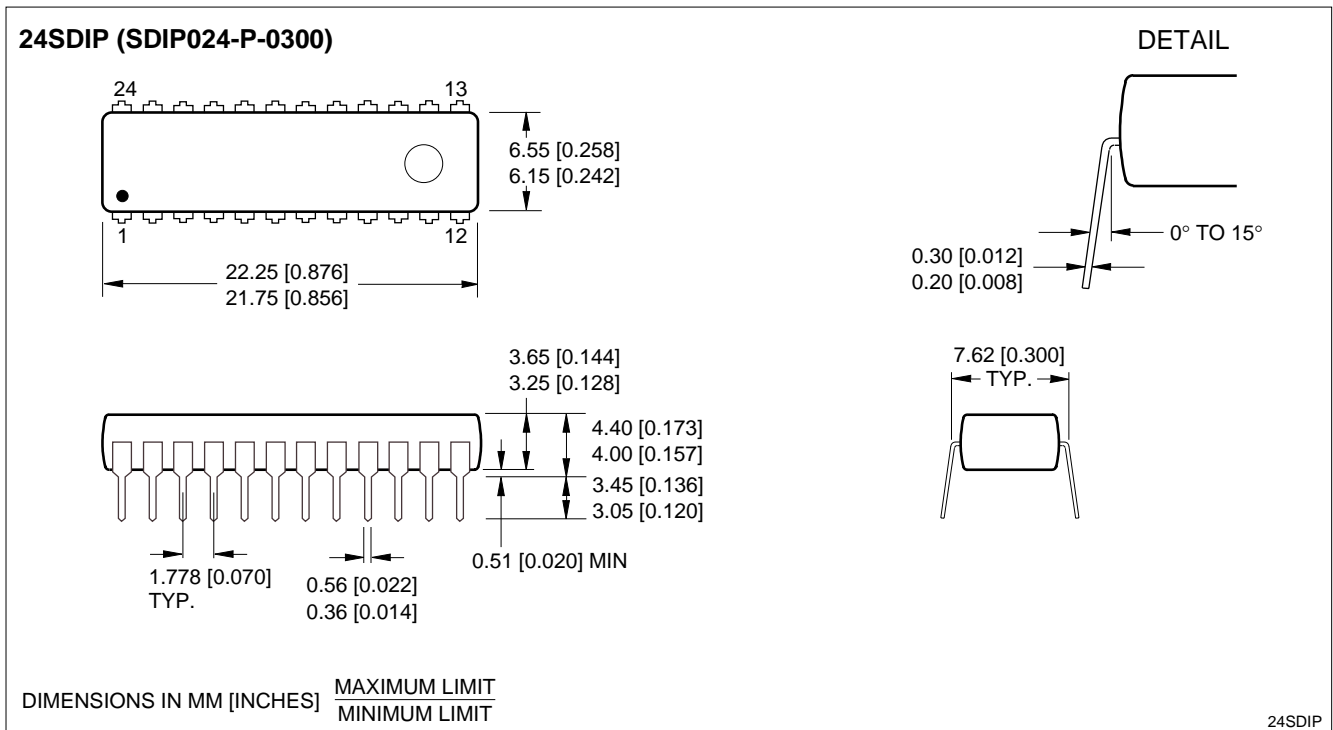

24-pin, 300-mil SK-DIP

24SOP (SOP024-P-0450B)

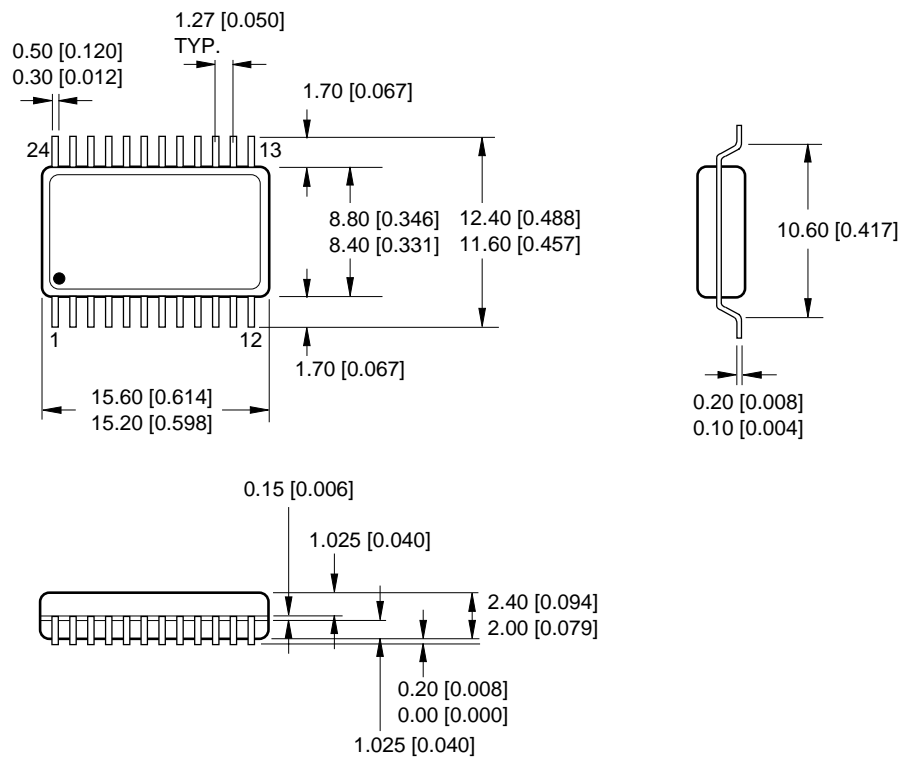

DIMENSIONS IN MM [INCHES] MAXIMUM LIMIT
 MINIMUM LIMIT

24SOP

24-pin, 450-mil SOP

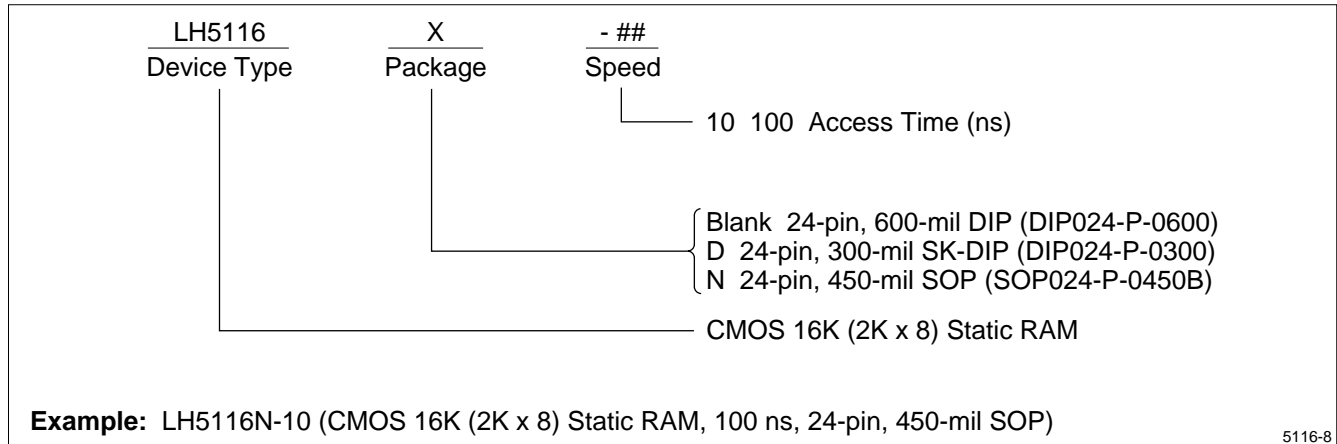
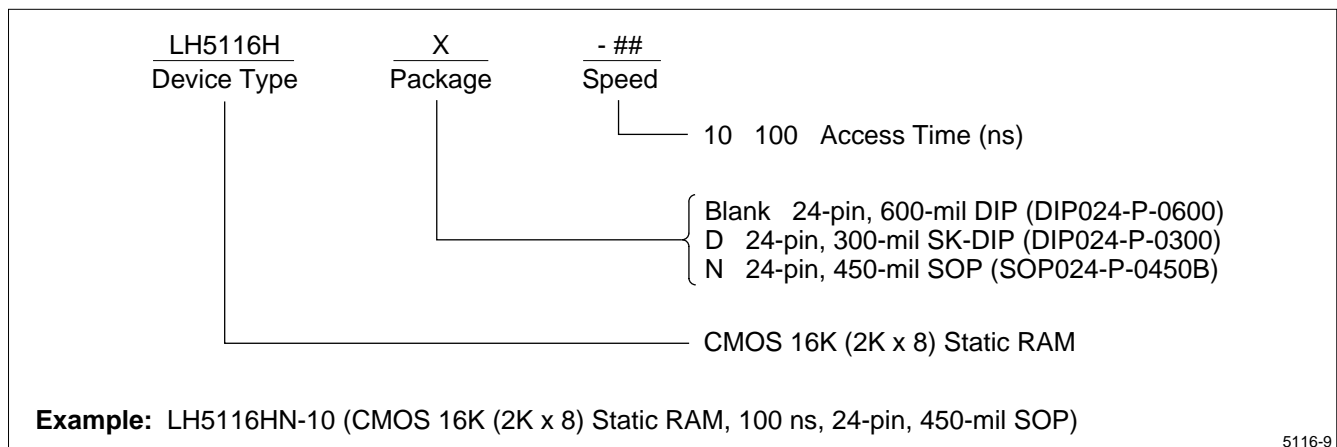
ORDERING INFORMATION ($T_A = 0^\circ\text{C}$ to 70°C)ORDERING INFORMATION ($T_A = -40^\circ\text{C}$ to $+85^\circ\text{C}$)

SPECIFICATIONS ARE SUBJECT TO CHANGE WITHOUT NOTICE.

Suggested applications (if any) are for standard use; See Important Restrictions for limitations on special applications. See Limited Warranty for SHARP's product warranty. The Limited Warranty is in lieu, and exclusive of, all other warranties, express or implied. ALL EXPRESS AND IMPLIED WARRANTIES, INCLUDING THE WARRANTIES OF MERCHANTABILITY, FITNESS FOR USE AND FITNESS FOR A PARTICULAR PURPOSE, ARE SPECIFICALLY EXCLUDED. In no event will SHARP be liable, or in any way responsible, for any incidental or consequential economic or property damage.

SHARP®

NORTH AMERICA

SHARP Microelectronics
of the Americas
5700 NW Pacific Rim Blvd.
Camas, WA 98607, U.S.A.
Phone: (360) 834-2500
Fax: (360) 834-8903
<http://www.sharpsma.com>

EUROPE

SHARP Microelectronics Europe
Sonninstraße 3
20097 Hamburg, Germany
Phone: (49) 40 2376-2286
Fax: (49) 40 2376-2232
<http://www.sharpsme.com>

ASIA

SHARP Corporation
Integrated Circuits Group
2613-1 Ichinomoto-Cho
Tenri-City, Nara, 632, Japan
Phone: +81-743-65-1321
Fax: +81-743-65-1532
<http://www.sharp.co.jp>