

HIGH VOLTAGE MEDIUM CURRENT DRIVER ARRAYS

DESCRIPTION

The SG2800 series integrates eight NPN Darlington pairs with internal suppression diodes to drive lamps, relays, and solenoids in many military, aerospace, and industrial applications that require severe environments. All units feature open collector outputs with greater than 50V breakdown voltages combined with 500mA current carrying capabilities. Five different input configurations provide optimized designs for interfacing with DTL, TTL, PMOS, or CMOS drive signals. These devices are designed to operate from -55°C to 125°C ambient temperature in a 18-pin dual in-line ceramic (J) package and 20-pin leadless chip carrier (LCC).

FEATURES

- Eight NPN Darlington pairs
- Collector currents to 600mA
- Output voltages from 50V to 95V
- Internal clamping diodes for inductive loads
- DTL, TTL, PMOS, or CMOS compatible inputs
- Hermetic ceramic package

HIGH RELIABILITY FEATURES

- ◆ Available to MIL-STD-883 and DESC SMD
- ◆ MIL-M38510/14106BVA - JAN2801J
- ◆ MIL-M38510/14107BVA - JAN2802J
- ◆ MIL-M38510/14108BVA - JAN2803J
- ◆ MIL-M38510/14109BVA - JAN2804J
- ◆ Radiation data available
- ◆ LMI level "S" processing available

PARTIAL SCHEMATICS

SG2801/2811/2821

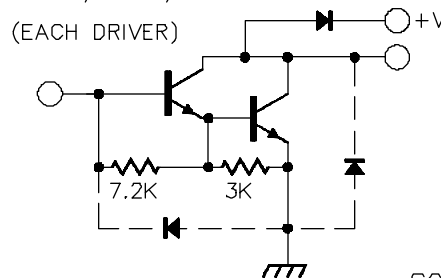

SG2802/2812

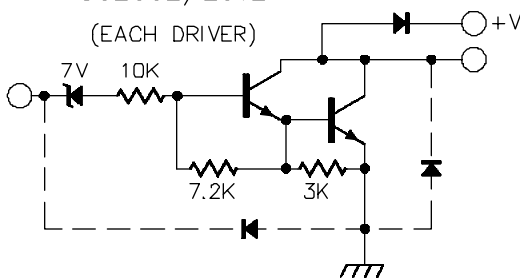

SG2803/2813/2823

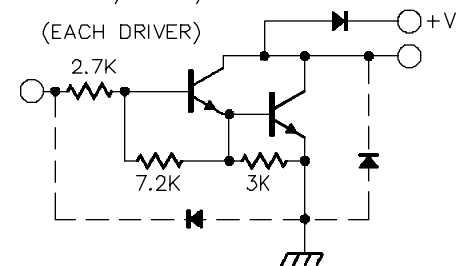

SG2804/2814/2824

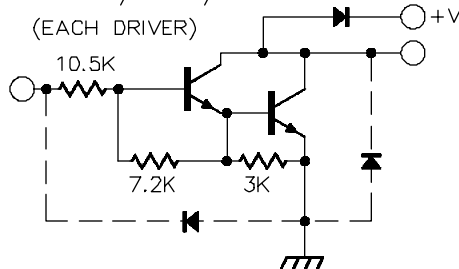

SG2805/2815

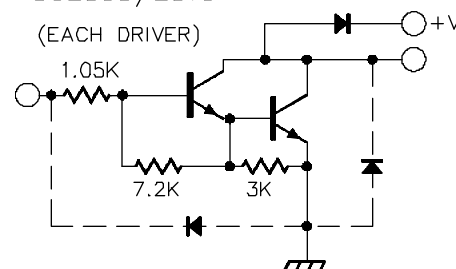

ABSOLUTE MAXIMUM RATINGS (Note 1)

| | |
|---|------|
| Output Voltage, V_{CE} (SG2800, 2810 series) | 50V |
| (SG2820 series) | 95V |
| Input Voltage, V_{IN} (SG2802,3,4 series) | 30V |
| Continuous Input Current, I_{IN} | 25mA |

Note 1. Values beyond which damage may occur.

THERMAL DATA

J Package:

| | |
|---|--------|
| Thermal Resistance-Junction to Case, θ_{JC} | 25°C/W |
| Thermal Resistance-Junction to Ambient, θ_{JA} | 70°C/W |

N Package:

| | |
|---|--------|
| Thermal Resistance-Junction to Case, θ_{JC} | 30°C/W |
| Thermal Resistance-Junction to Ambient, θ_{JA} | 60°C/W |

L Package:

| | |
|---|---------|
| Thermal Resistance-Junction to Case, θ_{JC} | 35°C/W |
| Thermal Resistance-Junction to Ambient, θ_{JA} | 120°C/W |

DW Package:

| | |
|---|--------|
| Thermal Resistance-Junction to Ambient, θ_{JA} | 90°C/W |
|---|--------|

| | |
|--|----------------|
| Continuous Collector Current, I_C (SG2800, 2820) | 500mA |
| (SG2810) | 600mA |
| Operating Junction Temperature Hermetic (J, L Packages) | 150°C |
| Plastic (N, DW Package) | 150°C |
| Storage Temperature Range | -65°C to 150°C |
| Lead Temperature (Soldering 10 sec.) | 300°C |
| RoHS Peak Package Solder Reflow Temp. (40 sec. max. exp.)..... | 260°C (+0, -5) |

Note A. Junction Temperature Calculation: $T_J = T_A + (P_D \times \theta_{JA})$.

Note B. The above numbers for θ_{JC} are maximums for the limiting thermal resistance of the package in a standard mounting configuration. The θ_{JA} numbers are meant to be guidelines for the thermal performance of the device/pc-board system. All of the above assume no ambient airflow.

RECOMMENDED OPERATING CONDITIONS (Note 2)

| | |
|---|-----|
| Output Voltage, V_{CE} SG2800, SG2820 series | 50V |
| SG2810 series | 95V |

Note 2. Range over which the device is functional.

| | |
|--|----------------|
| Peak Collector Current, I_C SG2800, SG2820 series | 350mA |
| SG2810 series | 500mA |
| Operating Ambient Temperature Range | -55°C to 125°C |

SELECTION GUIDE

| Device | V_{CE} Max | I_C Max | Logic Inputs |
|--------|--------------|-----------|-------------------------------|
| SG2801 | 50V | 500mA | General Purpose PMOS, CMOS |
| SG2802 | 50V | 500mA | 14V-25V PMOS |
| SG2803 | 50V | 500mA | 5V TTL, CMOS |
| SG2804 | 50V | 500mA | 6V-15V CMOS, PMOS |
| SG2811 | 50V | 600mA | General Purpose PMOS, CMOS |
| SG2812 | 50V | 600mA | 14V-25V PMOS |

| Device | V_{CE} Max | I_C Max | Logic Inputs |
|--------|--------------|-----------|-------------------------------|
| SG2813 | 50V | 600mA | 5V TTL, CMOS |
| SG2814 | 50V | 600mA | 6V-15V CMOS, PMOS |
| SG2815 | 50V | 600mA | High Output TTL |
| SG2821 | 95V | 500mA | General Purpose PMOS, CMOS |
| SG2823 | 95V | 500mA | 5V TTL, CMOS |
| SG2824 | 95V | 500mA | 6V-15V CMOS, PMOS |

ELECTRICAL CHARACTERISTICS

(Unless otherwise specified, these specifications apply over the operating ambient temperatures of $-55^{\circ}\text{C} \leq T_A \leq 125^{\circ}\text{C}$. Low duty cycle pulse testing techniques are used which maintains junction and case temperatures equal to the ambient temperature.)

SG2801 thru SG2804

| Parameter | Applicable Devices | Temp. | Test Conditions | Limits | | | Units |
|---|--------------------|--|--|--------|------|------|---------------|
| | | | | Min. | Typ. | Max. | |
| Output Leakage Current (I_{CEX}) | All | | $V_{CE} = 50\text{V}$ | | | 100 | μA |
| | SG2802 | | $V_{CE} = 50\text{V}, V_{IN} = 6\text{V}$ | | | 500 | μA |
| | SG2804 | | $V_{CE} = 50\text{V}, V_{IN} = 1\text{V}$ | | | 500 | μA |
| Collector - Emitter ($V_{CE(SAT)}$) | All | $T_A = T_{MIN}$ | $I_C = 350\text{mA}, I_B = 850\mu\text{A}$ | | 1.6 | 1.8 | V |
| | | $T_A = T_{MIN}$ | $I_C = 200\text{mA}, I_B = 550\mu\text{A}$ | | 1.3 | 1.5 | V |
| | | $T_A = T_{MIN}$ | $I_C = 100\text{mA}, I_B = 350\mu\text{A}$ | | 1.1 | 1.3 | V |
| | | $T_A = 25^{\circ}\text{C}$ | $I_C = 350\text{mA}, I_B = 500\mu\text{A}$ | | 1.25 | 1.6 | V |
| | | $T_A = 25^{\circ}\text{C}$ | $I_C = 200\text{mA}, I_B = 350\mu\text{A}$ | | 1.1 | 1.3 | V |
| | | $T_A = 25^{\circ}\text{C}$ | $I_C = 100\text{mA}, I_B = 250\mu\text{A}$ | | 0.9 | 1.1 | V |
| | | $T_A = T_{MAX}$ | $I_C = 350\text{mA}, I_B = 500\mu\text{A}$ | | 1.6 | 1.8 | V |
| | | $T_A = T_{MAX}$ | $I_C = 200\text{mA}, I_B = 350\mu\text{A}$ | | 1.3 | 1.5 | V |
| | | $T_A = T_{MAX}$ | $I_C = 100\text{mA}, I_B = 250\mu\text{A}$ | | 1.1 | 1.3 | V |
| Input Current ($I_{IN(ON)}$) | SG2802 | | $V_{IN} = 17\text{V}$ | 480 | 850 | 1300 | μA |
| | SG2803 | | $V_{IN} = 3.85\text{V}$ | 650 | 930 | 1350 | μA |
| | SG2804 | | $V_{IN} = 5\text{V}$ | 240 | 350 | 500 | μA |
| | | | $V_{IN} = 12\text{V}$ | 650 | 1000 | 1450 | μA |
| Input Voltage ($V_{IN(ON)}$) ($I_{IN(OFF)}$) | All | $T_A = T_{MAX}$ | $I_C = 500\mu\text{A}$ | 25 | 50 | | μA |
| | | $T_A = T_{MIN}$ | $V_{CE} = 2\text{V}, I_C = 300\text{mA}$ | | | 18 | V |
| | SG2802 | $T_A = T_{MIN}$ | $V_{CE} = 2\text{V}, I_C = 300\text{mA}$ | | | 13 | V |
| | | $T_A = T_{MAX}$ | $V_{CE} = 2\text{V}, I_C = 200\text{mA}$ | | | 3.3 | V |
| | | $T_A = T_{MIN}$ | $V_{CE} = 2\text{V}, I_C = 250\text{mA}$ | | | 3.6 | V |
| | | $T_A = T_{MIN}$ | $V_{CE} = 2\text{V}, I_C = 300\text{mA}$ | | | 3.9 | V |
| | | $T_A = T_{MAX}$ | $V_{CE} = 2\text{V}, I_C = 200\text{mA}$ | | | 2.4 | V |
| | | $T_A = T_{MAX}$ | $V_{CE} = 2\text{V}, I_C = 250\text{mA}$ | | | 2.7 | V |
| | | $T_A = T_{MAX}$ | $V_{CE} = 2\text{V}, I_C = 300\text{mA}$ | | | 3.0 | V |
| | | $T_A = T_{MIN}$ | $V_{CE} = 2\text{V}, I_C = 125\text{mA}$ | | | 6.0 | V |
| | SG2803 | $T_A = T_{MIN}$ | $V_{CE} = 2\text{V}, I_C = 200\text{mA}$ | | | 8.0 | V |
| | | $T_A = T_{MIN}$ | $V_{CE} = 2\text{V}, I_C = 275\text{mA}$ | | | 10 | V |
| | | $T_A = T_{MIN}$ | $V_{CE} = 2\text{V}, I_C = 350\text{mA}$ | | | 12 | V |
| | | $T_A = T_{MIN}$ | $V_{CE} = 2\text{V}, I_C = 125\text{mA}$ | | | 5.0 | V |
| | | $T_A = T_{MAX}$ | $V_{CE} = 2\text{V}, I_C = 200\text{mA}$ | | | 6.0 | V |
| | | $T_A = T_{MAX}$ | $V_{CE} = 2\text{V}, I_C = 275\text{mA}$ | | | 7.0 | V |
| $T_A = T_{MAX}$ | | $V_{CE} = 2\text{V}, I_C = 350\text{mA}$ | | | 8.0 | V | |
| $T_A = T_{MAX}$ | | $V_{CE} = 2\text{V}, I_C = 350\text{mA}$ | | | | | |
| D-C Forward Current Transfer Ratio (h_{FE}) | SG2801 | $T_A = T_{MIN}$ | $V_{CE} = 2\text{V}, I_C = 350\text{mA}$ | 500 | | | |
| | | $T_A = 25^{\circ}\text{C}$ | $V_{CE} = 2\text{V}, I_C = 350\text{mA}$ | 1000 | | | |
| Input Capacitance (C_{IN}) (Note 3) | All | $T_A = 25^{\circ}\text{C}$ | | | 15 | 25 | pF |
| Turn-On Delay (TPLH) | All | $T_A = 25^{\circ}\text{C}$ | $0.5 E_{IN}$ to $0.5 E_{OUT}$ | 250 | 1000 | | ns |
| Turn-Off Delay (TPHL) | All | $T_A = 25^{\circ}\text{C}$ | $0.5 E_{IN}$ to $0.5 E_{OUT}$ | 250 | 1000 | | ns |
| Clamp Diode Leakage Current (I_R) | All | | $V_R = 50\text{V}$ | | | 50 | μA |
| Clamp Diode Forward Voltage (V_F) | All | | $I_F = 350\text{mA}$ | | 1.7 | 2.0 | V |

Note 3. These parameters, although guaranteed, are not tested in production.

ELECTRICAL CHARACTERISTICS (continued)

SG2811 thru SG2815

| Parameter | Applicable Devices | Temp. | Test Conditions | Limits | | | Units | |
|--|--------------------|--------------------|--------------------------------|----------------------------|------|------|---------|---|
| | | | | Min. | Typ. | Max. | | |
| Output Leakage Current (I_{CEX}) | All | | $V_{CE} = 50V$ | | | 100 | μA | |
| | SG2812 | | $V_{CE} = 50V, V_{IN} = 6V$ | | | 500 | μA | |
| | SG2814 | | $V_{CE} = 50V, V_{IN} = 1V$ | | | 500 | μA | |
| Collector - Emitter ($V_{CE(SAT)}$) | All | $T_A = T_{MIN}$ | $I_C = 500mA, I_B = 1100\mu A$ | | 1.8 | 2.1 | V | |
| | | $T_A = T_{MIN}$ | $I_C = 350mA, I_B = 850\mu A$ | | 1.6 | 1.8 | V | |
| | | $T_A = T_{MIN}$ | $I_C = 200mA, I_B = 550\mu A$ | | 1.3 | 1.5 | V | |
| | | $T_A = 25^\circ C$ | $I_C = 500mA, I_B = 600\mu A$ | | 1.7 | 1.9 | V | |
| | | $T_A = 25^\circ C$ | $I_C = 350mA, I_B = 500\mu A$ | | 1.25 | 1.6 | V | |
| | | $T_A = 25^\circ C$ | $I_C = 200mA, I_B = 350\mu A$ | | 1.1 | 1.3 | V | |
| | | $T_A = T_{MAX}$ | $I_C = 500mA, I_B = 600\mu A$ | | 1.8 | 2.1 | V | |
| | | $T_A = T_{MAX}$ | $I_C = 350mA, I_B = 500\mu A$ | | 1.6 | 1.8 | V | |
| | | $T_A = T_{MAX}$ | $I_C = 200mA, I_B = 350\mu A$ | | 1.3 | 1.5 | V | |
| Input Current ($I_{IN(ON)}$) | SG2812 | | $V_{IN} = 17V$ | 480 | 850 | 1300 | μA | |
| | SG2813 | | $V_{IN} = 3.85V$ | 650 | 930 | 1350 | μA | |
| | SG2814 | | $V_{IN} = 5V$ | 240 | 350 | 500 | μA | |
| | SG2815 | | $V_{IN} = 12V$ | 650 | 1000 | 1450 | μA | |
| | | | $V_{IN} = 3V$ | 1180 | 1500 | 2400 | μA | |
| Input Voltage ($V_{IN(OFF)}$) ($I_{IN(OFF)}$) | All | $T_A = T_{MAX}$ | $I_C = 500\mu A$ | 25 | 50 | | μA | |
| | SG2812 | $T_A = T_{MIN}$ | $V_{CE} = 2V, I_C = 500mA$ | | | 23.5 | V | |
| | | $T_A = T_{MAX}$ | $V_{CE} = 2V, I_C = 500mA$ | | | 17 | V | |
| | | SG2813 | $T_A = T_{MIN}$ | $V_{CE} = 2V, I_C = 250mA$ | | | 3.6 | V |
| | | | $T_A = T_{MIN}$ | $V_{CE} = 2V, I_C = 300mA$ | | | 3.9 | V |
| | SG2814 | $T_A = T_{MIN}$ | $V_{CE} = 2V, I_C = 500mA$ | | | 6.0 | V | |
| | | $T_A = T_{MAX}$ | $V_{CE} = 2V, I_C = 250mA$ | | | 2.7 | V | |
| | | $T_A = T_{MAX}$ | $V_{CE} = 2V, I_C = 300mA$ | | | 3.0 | V | |
| | | $T_A = T_{MAX}$ | $V_{CE} = 2V, I_C = 500mA$ | | | 3.5 | V | |
| | | $T_A = T_{MIN}$ | $V_{CE} = 2V, I_C = 275mA$ | | | 10 | V | |
| | | $T_A = T_{MIN}$ | $V_{CE} = 2V, I_C = 350mA$ | | | 12 | V | |
| | | $T_A = T_{MIN}$ | $V_{CE} = 2V, I_C = 500mA$ | | | 17 | V | |
| | | $T_A = T_{MAX}$ | $V_{CE} = 2V, I_C = 275mA$ | | | 7.0 | V | |
| | SG2815 | $T_A = T_{MAX}$ | $V_{CE} = 2V, I_C = 350mA$ | | | 8.0 | V | |
| | | $T_A = T_{MAX}$ | $V_{CE} = 2V, I_C = 500mA$ | | | 9.5 | V | |
| | | $T_A = T_{MIN}$ | $V_{CE} = 2V, I_C = 350mA$ | | | 3.0 | V | |
| | | $T_A = T_{MIN}$ | $V_{CE} = 2V, I_C = 500mA$ | | | 3.5 | V | |
| | | $T_A = T_{MAX}$ | $V_{CE} = 2V, I_C = 350mA$ | | | 2.4 | V | |
| | | $T_A = T_{MAX}$ | $V_{CE} = 2V, I_C = 500mA$ | | | 2.6 | V | |
| | | SG2811 | $T_A = T_{MIN}$ | $V_{CE} = 2V, I_C = 500mA$ | | 450 | | |
| $T_A = 25^\circ C$ | | | $V_{CE} = 2V, I_C = 500mA$ | | 900 | | | |
| Transfer Ratio (h_{FE}) | All | $T_A = 25^\circ C$ | | | | | | |
| Input Capacitance (C_{IN}) (Note 3) | All | $T_A = 25^\circ C$ | | 15 | 25 | pF | | |
| Turn-On Delay (TPLH) | All | $T_A = 25^\circ C$ | $0.5 E_{IN}$ to $0.5 E_{OUT}$ | 250 | 1000 | ns | | |
| Turn-Off Delay (TPHL) | All | $T_A = 25^\circ C$ | $0.5 E_{IN}$ to $0.5 E_{OUT}$ | 250 | 1000 | ns | | |
| Clamp Diode Leakage Current (I_R) | All | | $V_R = 50V$ | | | 50 | μA | |
| Clamp Diode Forward Voltage (V_F) | All | | $I_F = 350mA$ | | 1.7 | 2.0 | V | |
| | | | $I_F = 500mA$ | | | 2.5 | V | |

Note 3. These parameters, although guaranteed, are not tested in production.

ELECTRICAL CHARACTERISTICS (continued)

SG2821 thru SG2824

| Parameter | Applicable Devices | Temp. | Test Conditions | Limits | | | Units |
|---|---------------------|--------------------------------|-------------------------------|----------------------------|------------------|------|---------|
| | | | | Min. | Typ. | Max. | |
| Output Leakage Current (I_{CEX}) | All | | $V_{CE} = 95V$ | | | 100 | μA |
| | SG2824 | | $V_{CE} = 95V, V_{IN} = 1V$ | | | 500 | μA |
| Collector - Emitter ($V_{CE(SAT)}$) | All | $T_A = T_{MIN}$ | $I_C = 350mA, I_B = 850\mu A$ | | 1.6 | 1.8 | V |
| | | $T_A = T_{MIN}$ | $I_C = 200mA, I_B = 550\mu A$ | | 1.3 | 1.5 | V |
| | | $T_A = T_{MIN}$ | $I_C = 100mA, I_B = 350\mu A$ | | 1.1 | 1.3 | V |
| | | $T_A = 25^\circ C$ | $I_C = 350mA, I_B = 500\mu A$ | | 1.25 | 1.6 | V |
| | | $T_A = 25^\circ C$ | $I_C = 200mA, I_B = 350\mu A$ | | 1.1 | 1.3 | V |
| | | $T_A = 25^\circ C$ | $I_C = 100mA, I_B = 250\mu A$ | | 0.9 | 1.1 | V |
| | | $T_A = T_{MAX}$ | $I_C = 350mA, I_B = 500\mu A$ | | 1.6 | 1.8 | V |
| | | $T_A = T_{MAX}$ | $I_C = 200mA, I_B = 350\mu A$ | | 1.3 | 1.5 | V |
| | | $T_A = T_{MAX}$ | $I_C = 100mA, I_B = 250\mu A$ | | 1.1 | 1.3 | V |
| | | Input Current ($I_{IN(ON)}$) | SG2823 | | $V_{IN} = 3.85V$ | 650 | 930 |
| SG2824 | | | $V_{IN} = 5V$ | 240 | 350 | 500 | μA |
| | | | $V_{IN} = 12V$ | 650 | 1000 | 1450 | μA |
| $I_{IN(OFF)}$ | All | $T_A = T_{MAX}$ | $I_C = 500\mu A$ | 25 | 50 | | μA |
| Input Voltage ($V_{IN(ON)}$) | SG2823 | $T_A = T_{MAX}$ | $V_{CE} = 2V, I_C = 300mA$ | | | 13 | V |
| | | $T_A = T_{MIN}$ | $V_{CE} = 2V, I_C = 200mA$ | | | 3.3 | V |
| | | $T_A = T_{MIN}$ | $V_{CE} = 2V, I_C = 250mA$ | | | 3.6 | V |
| | | $T_A = T_{MIN}$ | $V_{CE} = 2V, I_C = 300mA$ | | | 3.9 | V |
| | | $T_A = T_{MAX}$ | $V_{CE} = 2V, I_C = 200mA$ | | | 2.4 | V |
| | | $T_A = T_{MAX}$ | $V_{CE} = 2V, I_C = 250mA$ | | | 2.7 | V |
| | | $T_A = T_{MAX}$ | $V_{CE} = 2V, I_C = 300mA$ | | | 3.0 | V |
| | | SG2824 | $T_A = T_{MIN}$ | $V_{CE} = 2V, I_C = 125mA$ | | | 6.0 |
| | $T_A = T_{MIN}$ | | $V_{CE} = 2V, I_C = 200mA$ | | | 8.0 | V |
| | $T_A = T_{MIN}$ | | $V_{CE} = 2V, I_C = 275mA$ | | | 10 | V |
| | $T_A = T_{MIN}$ | | $V_{CE} = 2V, I_C = 350mA$ | | | 12 | V |
| | $T_A = T_{MAX}$ | | $V_{CE} = 2V, I_C = 125mA$ | | | 5.0 | V |
| | $T_A = T_{MAX}$ | | $V_{CE} = 2V, I_C = 200mA$ | | | 6.0 | V |
| | $T_A = T_{MAX}$ | | $V_{CE} = 2V, I_C = 275mA$ | | | 7.0 | V |
| | $T_A = T_{MAX}$ | | $V_{CE} = 2V, I_C = 350mA$ | | | 8.0 | V |
| | D-C Forward Current | SG2821 | $T_A = T_{MIN}$ | $V_{CE} = 2V, I_C = 350mA$ | 500 | | |
| Transfer Ratio (h_{FE}) | | $T_A = 25^\circ C$ | $V_{CE} = 2V, I_C = 350mA$ | 1000 | | | |
| Input Capacitance (C_{IN}) (Note 3) | All | $T_A = 25^\circ C$ | | | 15 | 25 | pF |
| Turn-On Delay (TPLH) | All | $T_A = 25^\circ C$ | $0.5 E_{IN}$ to $0.5 E_{OUT}$ | | 250 | 1000 | ns |
| Turn-Off Delay (TPHL) | All | $T_A = 25^\circ C$ | $0.5 E_{IN}$ to $0.5 E_{OUT}$ | | 250 | 1000 | ns |
| Clamp Diode Leakage Current (I_R) | All | | $V_R = 95V$ | | | 50 | μA |
| Clamp Diode Forward Voltage (V_F) | All | | $I_F = 350mA$ | | 1.7 | 2.0 | V |

Note 3. These parameters, although guaranteed, are not tested in production.

CHARACTERISTIC CURVES

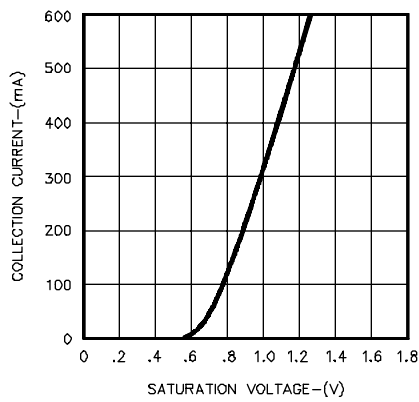

FIGURE 1.
OUTPUT CHARACTERISTICS

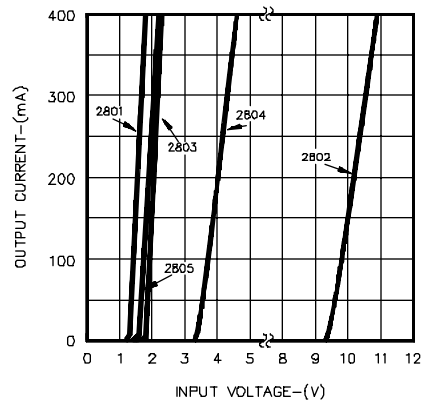

FIGURE 2.
OUTPUT CURRENT VS. INPUT VOLTAGE

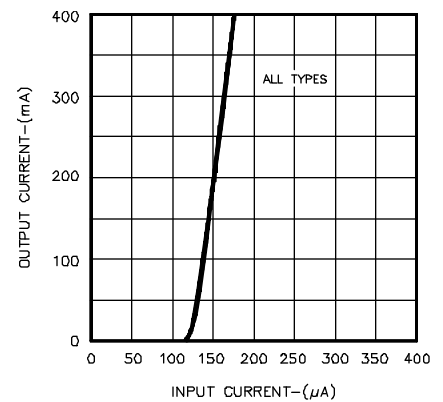

FIGURE 3.
OUTPUT CURRENT VS. INPUT CURRENT

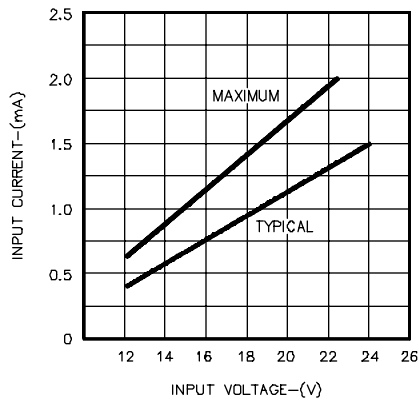

FIGURE 4.
INPUT CHARACTERISTICS - SG2802

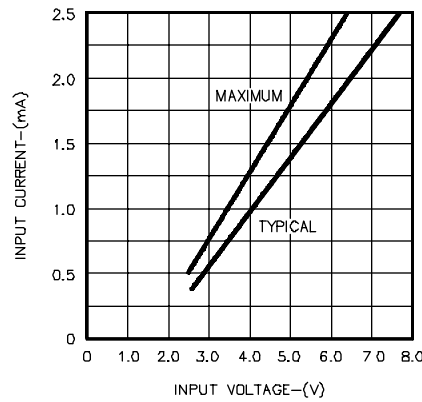

FIGURE 5.
INPUT CHARACTERISTICS - SG2803

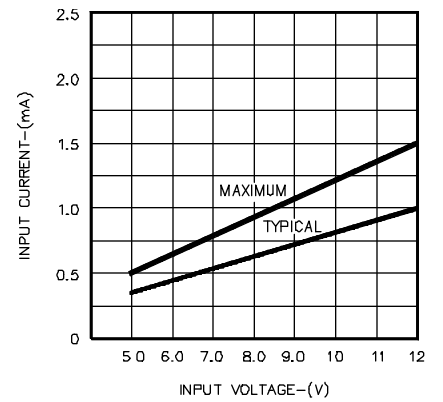

FIGURE 6.
INPUT CHARACTERISTICS - SG2804

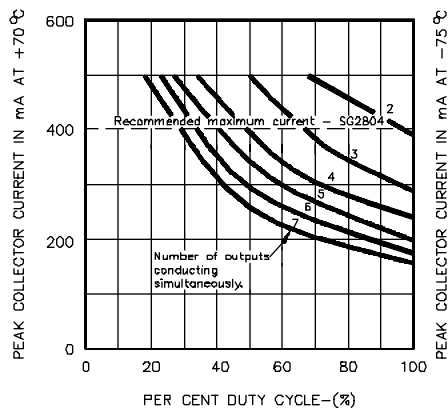
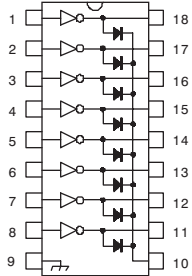
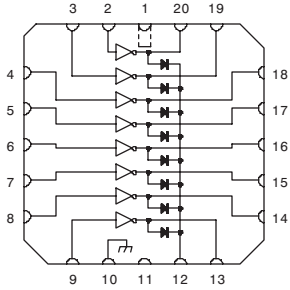

FIGURE 7.
PEAK COLLECTOR CURRENT VS. DUTY CYCLE

CONNECTION DIAGRAMS & ORDERING INFORMATION (See Notes Below)

| Package | Part No. (Note 3) | Ambient Temperature Range | Connection Diagram |
|---|---|--|---|
| 18-PIN CERAMIC DIP J - PACKAGE | SG28XXJ/883B JAN2801J JAN2802J JAN2803J JAN2804J SG2803J/DESC SG2821J/DESC SG2823J/DESC SG2824J/DESC SG28XXJ | -55°C to 125°C -55°C to 125°C -55°C to 125°C -55°C to 125°C -55°C to 125°C -55°C to 125°C -55°C to 125°C -55°C to 125°C -55°C to 125°C |  |
| 18-PIN PLASTIC DIP N - PACKAGE | SG2803N SG2823N | 0°C to 70°C 0°C to 70°C | N Package: RoHS Compliant / Pb-free Transition DC: 0503 N Package: RoHS / Pb-free 100% Matte Tin Lead Finish |
| 18-PIN PLASTIC DIP DW - PACKAGE | SG2803DW SG2823DW | 0°C to 70°C 0°C to 70°C | DW Package: RoHS Compliant / Pb-free Transition DC: 0516 DW Package: RoHS / Pb-free 100% Matte Tin Lead Finish |
| 20-PIN CERAMIC LEADLESS CHIP CARRIER L- PACKAGE | SG28XXL/883B SG2803L/DESC SG2821L/DESC SG2823L/DESC SG2824L/DESC SG28XXL | -55°C to 125°C -55°C to 125°C -55°C to 125°C -55°C to 125°C -55°C to 125°C -55°C to 125°C |  |

- Note**
1. Contact factory for JAN and DESC product availability.
 2. All parts are viewed from the top.
 3. See Selection Guide for specific device types.