

# 64K x 1 Static RAM

## Features

- **High speed**  
— 15 ns
- **CMOS for optimum speed/power**
- **Low active power**  
— 495 mW
- **Low standby power**  
— 110 mW
- **TTL compatible inputs and outputs**
- **Automatic power-down when deselected**
- **Available in Pb-free and non Pb-free 22-pin (300-Mil) Molded DIP and 24-pin (300-Mil) Molded SOJ**

## Functional Description

The CY7C187 is a high-performance CMOS static RAM organized as 65,536 words x 1 bit. Easy memory expansion is provided by an active LOW Chip Enable (CE) and tri-state drivers. The CY7C187 has an automatic power-down feature, reducing the power consumption by 56% when deselected.

Writing to the device is accomplished when the Chip Enable (CE) and Write Enable (WE) inputs are both LOW. Data on the input pin (D<sub>IN</sub>) is written into the memory location specified on the address pins (A<sub>0</sub> through A<sub>15</sub>).

Reading the device is accomplished by taking the Chip Enable (CE) LOW, while Write Enable (WE) remains HIGH. Under these conditions, the contents of the memory location specified on the address pin will appear on the data output (D<sub>OUT</sub>) pin.

The output pin stays in high-impedance state when Chip Enable (CE) is HIGH or Write Enable (WE) is LOW.

The CY7C187 utilizes a die coat to insure alpha immunity.

## Logic Block Diagram

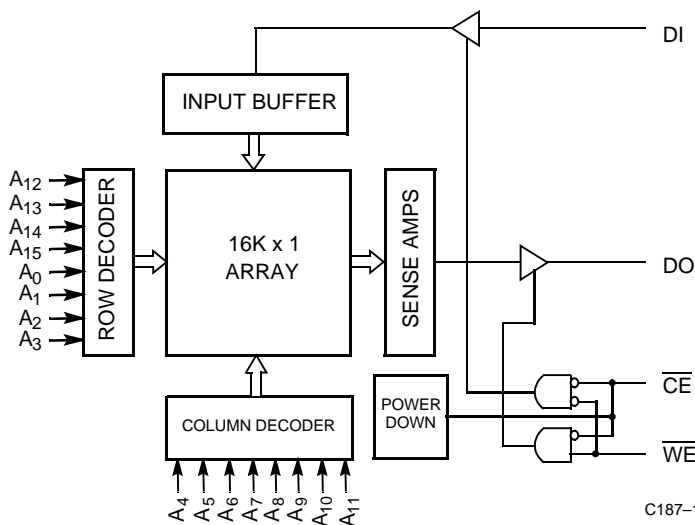

## Pin Configurations

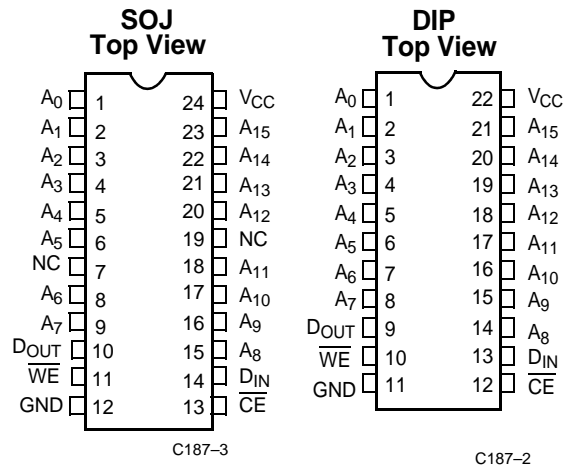

## Selection Guide

	-15	-25	-35
Maximum Access Time (ns)	15	25	35
Maximum Operating Current (mA)	90	70	70
Maximum CMOS Standby Current (mA)	20	20	20

**Maximum Ratings**

(Above which the useful life may be impaired. For user guidelines, not tested.)

- Storage Temperature .....-65°C to +150°C
- Ambient Temperature with Power Applied.....-55°C to +125°C
- Supply Voltage to Ground Potential (Pin 22 to Pin 11) ..... -0.5V to +7.0V
- DC Voltage Applied to Outputs in High Z State<sup>[1]</sup> ..... -0.5V to +7.0V

- DC Input Voltage<sup>[1]</sup> .....-0.5V to +7.0V
- Output Current into Outputs (LOW)..... 20 mA
- Static Discharge Voltage..... >2001V (per MIL-STD-883, Method 3015)
- Latch-Up Current..... >200 mA

**Operating Range**

Range	Ambient Temperature	V <sub>CC</sub>
Commercial	0°C to +70°C	5V ± 10%

**Electrical Characteristics Over the Operating Range**

Parameter	Description	Test Conditions	-15		-25 and -35		Unit
			Min.	Max.	Min.	Max.	
V <sub>OH</sub>	Output HIGH Voltage	V <sub>CC</sub> = Min., I <sub>OH</sub> = -4.0mA	2.4		2.4		V
V <sub>OL</sub>	Output LOW Voltage	V <sub>CC</sub> = Min., I <sub>OL</sub> = 12.0 mA		0.4		0.4	V
V <sub>IH</sub>	Input HIGH Voltage		2.2	V <sub>CC</sub>	2.2	V <sub>CC</sub>	V
V <sub>IL</sub>	Input LOW Voltage <sup>[1]</sup>		-0.5	0.8	-0.5	0.8	V
I <sub>IX</sub>	Input Leakage Current	GND ≤ V <sub>I</sub> ≤ V <sub>CC</sub>	-5	+5	-5	+5	μA
I <sub>OZ</sub>	Output Leakage Current	GND ≤ V <sub>O</sub> ≤ V <sub>CC</sub> , Output Disabled	-5	+5	-5	+5	μA
I <sub>CC</sub>	V <sub>CC</sub> Operating Supply Current	V <sub>CC</sub> = Max., I <sub>OUT</sub> = 0 mA		90		70	mA
I <sub>SB1</sub>	Automatic $\overline{CE}$ Power-Down Current <sup>[3]</sup>	Max. V <sub>CC</sub> , $\overline{CE} \geq V_{IH}$		40		20	mA
I <sub>SB2</sub>	Automatic $\overline{CE}$ Power-Down Current	Max. V <sub>CC</sub> , $\overline{CE} \geq V_{CC} - 0.3V$ , V <sub>IN</sub> ≥ V <sub>CC</sub> - 0.3V or V <sub>IN</sub> ≤ 0.3V		20		20	mA

**Capacitance<sup>[4]</sup>**

Parameter	Description	Test Conditions	Max.	Unit
C <sub>IN</sub>	Input Capacitance	T <sub>A</sub> = 25°C, f = 1 MHz, V <sub>CC</sub> = 5.0V	10	pF
C <sub>OUT</sub>	Output Capacitance		10	pF

**AC Test Loads and Waveforms**

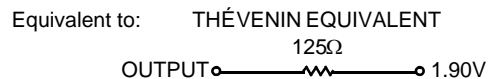
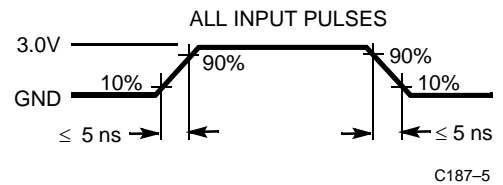
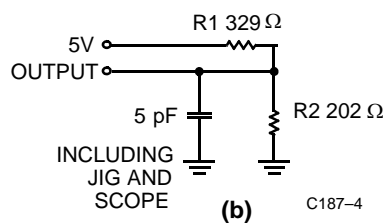
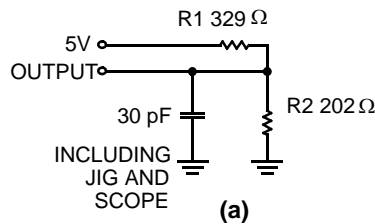

**Notes:**

1. V<sub>IL</sub> (min.) = -3.0V for pulse durations less than 30 ns.
2. Not more than 1 output should be shorted at one time. Duration of the short circuit should not exceed 30 seconds.
3. A pull-up resistor to V<sub>CC</sub> on the CE input is required to keep the device deselected during V<sub>CC</sub> power-up, otherwise I<sub>SB</sub> will exceed values given.
4. Tested initially and after any design or process changes that may affect these parameters.

**Switching Characteristics** Over the Operating Range<sup>[5]</sup>

Parameter	Description	-15		-25		-35		Unit
		Min.	Max.	Min.	Max.	Min.	Max.	
<b>READ CYCLE</b>								
$t_{RC}$	Read Cycle Time	15		25		35		ns
$t_{AA}$	Address to Data Valid		15		25		35	ns
$t_{OHA}$	Output Hold from Address Change	3		5		5		ns
$t_{ACE}$	$\overline{CE}$ LOW to Data Valid		15		25		35	ns
$t_{LZCE}$	$\overline{CE}$ LOW to Low Z <sup>[6]</sup>	3		5		5		ns
$t_{HZCE}$	$\overline{CE}$ HIGH to High Z <sup>[6, 7]</sup>		8		10		15	ns
$t_{PU}$	$\overline{CE}$ LOW to Power Up	0		0		0		ns
$t_{PD}$	$\overline{CE}$ HIGH to Power Down		15		20		20	ns
<b>WRITE CYCLE<sup>[8]</sup></b>								
$t_{WC}$	Write Cycle Time	15		20		25		ns
$t_{SCE}$	$\overline{CE}$ LOW to Write End	12		20		25		ns
$t_{AW}$	Address Set-Up to Write End	12		20		25		ns
$t_{HA}$	Address Hold from Write End	0		0		0		ns
$t_{SA}$	Address Set-Up to Write Start	0		0		0		ns
$t_{PWE}$	$\overline{WE}$ Pulse Width	12		15		20		ns
$t_{SD}$	Data Set-Up to Write End	10		10		15		ns
$t_{HD}$	Data Hold from Write End	0		0		0		ns
$t_{LZWE}$	$\overline{WE}$ HIGH to Low Z	5		5		5		ns
$t_{HZWE}$	$\overline{WE}$ LOW to High Z <sup>[7]</sup>		7		7		10	ns

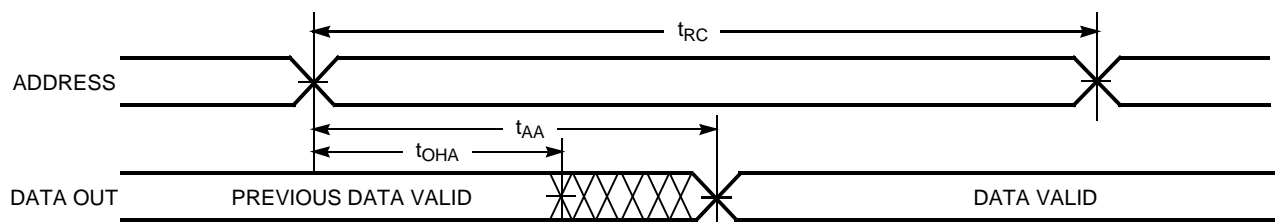
**Switching Waveforms**
**Read Cycle No. 1<sup>[9, 10]</sup>**

C187-6

**Notes:**

- Test conditions assume signal transition time of 5 ns or less, timing reference levels of 1.5V, input pulse levels of 0 to 3.0V, and output loading of the specified  $I_{OL}/I_{OH}$  and 30-pF load capacitance.
- At any given temperature and voltage condition,  $t_{HZCE}$  is less than  $t_{LZCE}$  for any given device.
- $t_{HZCE}$  and  $t_{HZWE}$  are specified with  $C_L = 5$  pF as in part (b) of AC Test Loads. Transition is measured  $\pm 500$  mV from steady-state voltage.
- The internal write time of the memory is defined by the overlap of  $\overline{CE}$  LOW and  $\overline{WE}$  LOW. Both signals must be LOW to initiate a write and either signal can terminate a write by going HIGH. The data input set-up and hold timing should be referenced to the rising edge of the signal that terminates the write.
- $\overline{WE}$  is HIGH for read cycle.
- Device is continuously selected,  $\overline{CE} = V_{IL}$ .

Switching Waveforms

Read Cycle No. 2<sup>[9, 11]</sup>

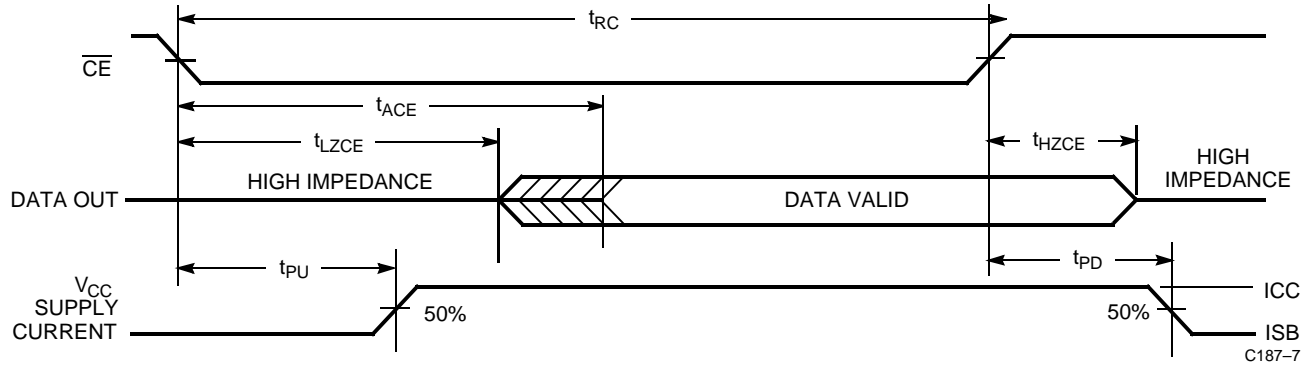

Write Cycle No. 1 (WE Controlled)<sup>[11]</sup>

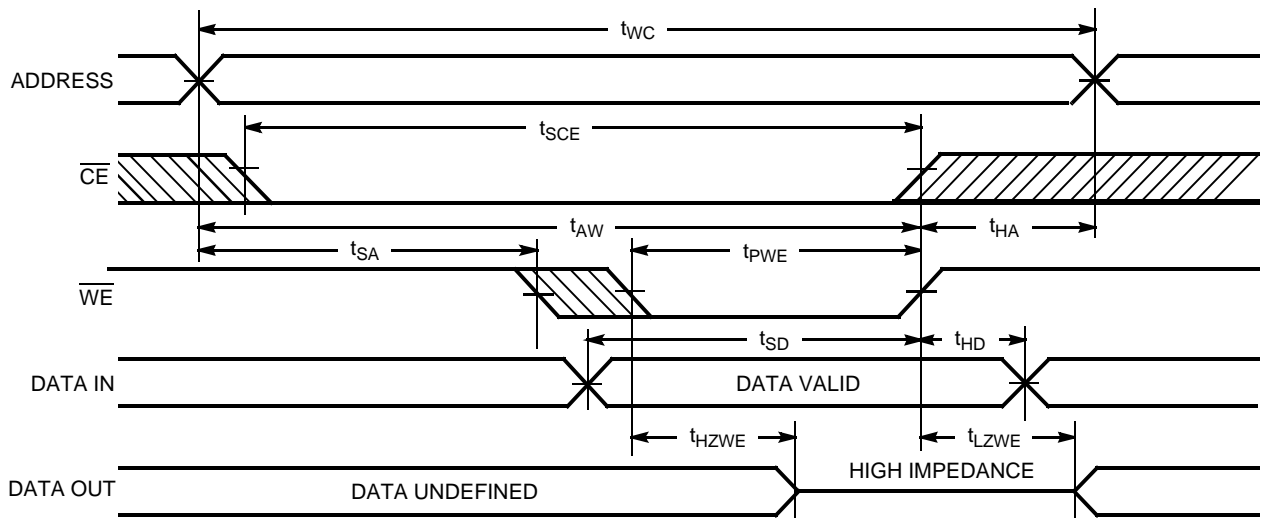

C187-8

Note:

11. Address valid prior to or coincident with  $\overline{CE}$  transition LOW.

### Switching Waveforms

Write Cycle No. 2(CE Controlled)<sup>[11,13]</sup>

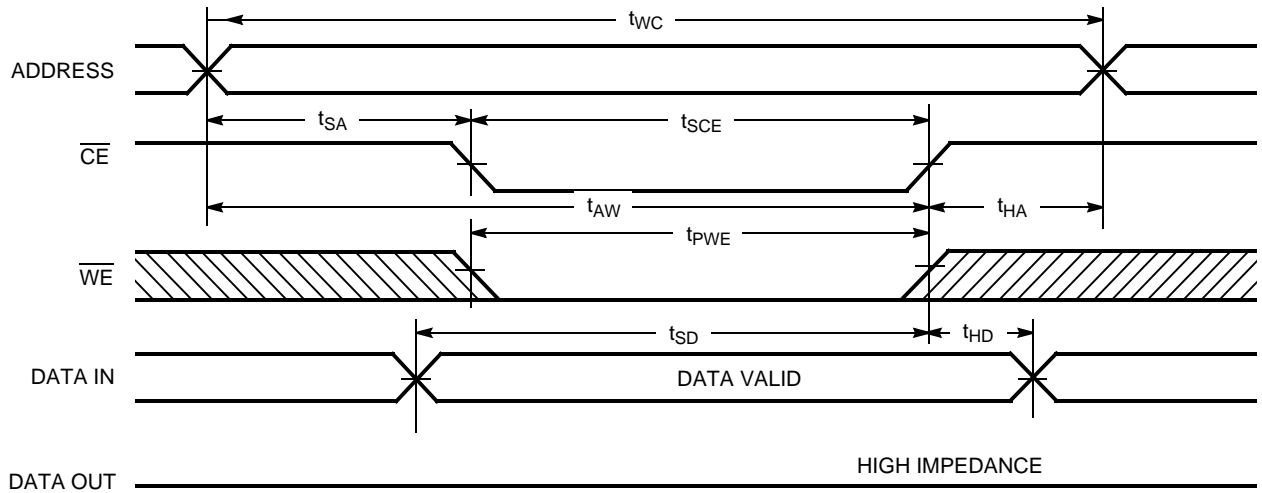

C187-9

### Typical DC and AC Characteristics

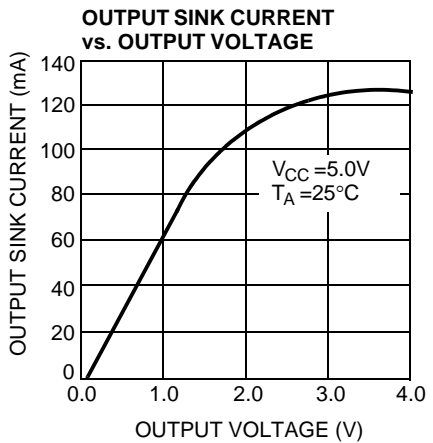
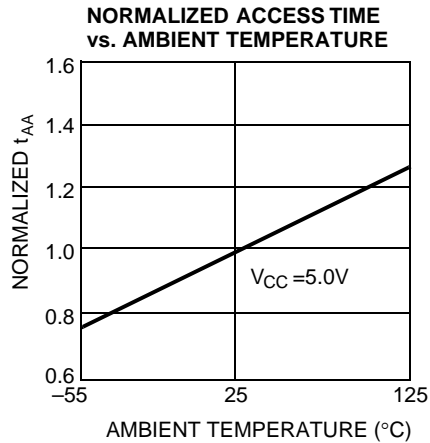
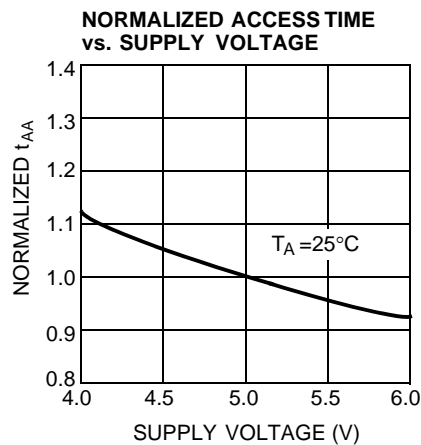
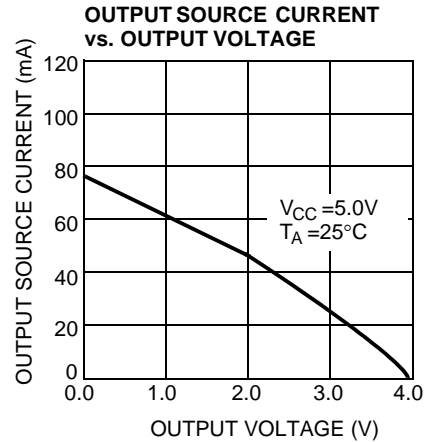
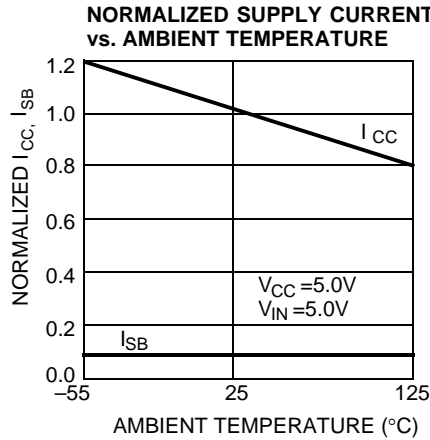
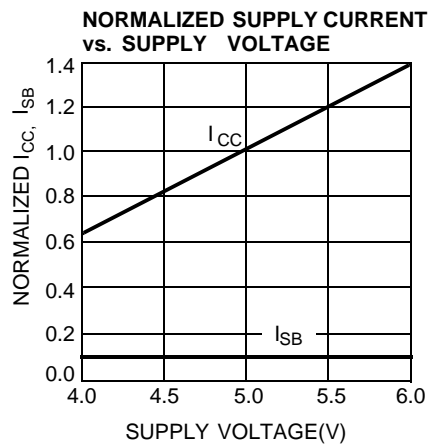

**Note:**

12. If CE goes HIGH simultaneously with WE HIGH, the output remains in a high-impedance state.

Typical DC and AC Characteristics (Continued)

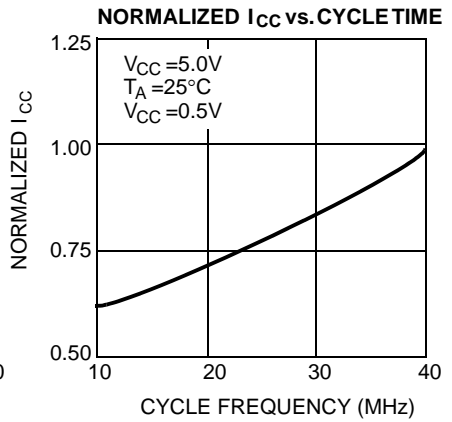
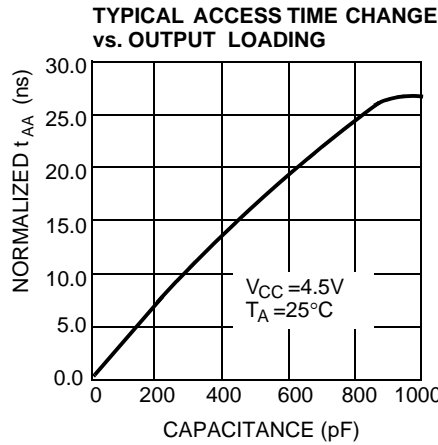
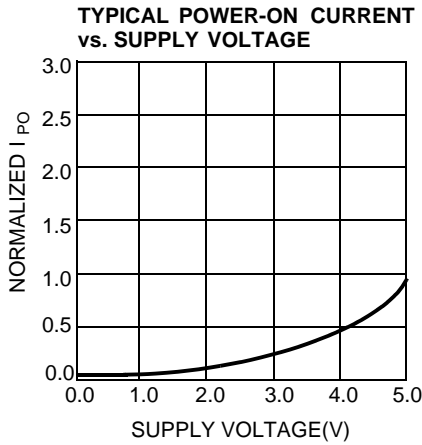

Address Designators

Address Name	Address Function	Pin Number
A0	X3	1
A1	X4	2
A2	X5	3
A3	X6	4
A4	X7	5
A5	Y7	6
A6	Y6	7
A7	Y2	8
A8	Y3	14
A9	Y1	15
A10	Y0	16
A11	Y4	17
A12	Y5	18
A13	X0	19
A14	X1	20
A15	X2	21

Truth Table

CE	WE	Input/Output	Mode
H	X	High Z	Deselect/Power-Down
L	H	Data Out	Read
L	L	Data In	Write

**Ordering Information**

Speed (ns)	Ordering Code	Package Diagram	Package Type	Operating Range
15	CY7C187-15PXC	51-85012	22-pin (300-Mil) Molded DIP (Pb-free)	Commercial
25	CY7C187-25PC	51-85012	22-pin (300-Mil) Molded DIP	Commercial
	CY7C187-25VC	51-85030	24-pin (300-Mil) Molded SOJ	
	CY7C187-25VXC		24-pin (300-Mil) Molded SOJ (Pb-free)	
35	CY7C187-35VXC	51-85030	24-pin (300-Mil) Molded SOJ (Pb-free)	Commercial

**Package Diagrams**

**22-pin (300-Mil) PDIP (51-85012)**

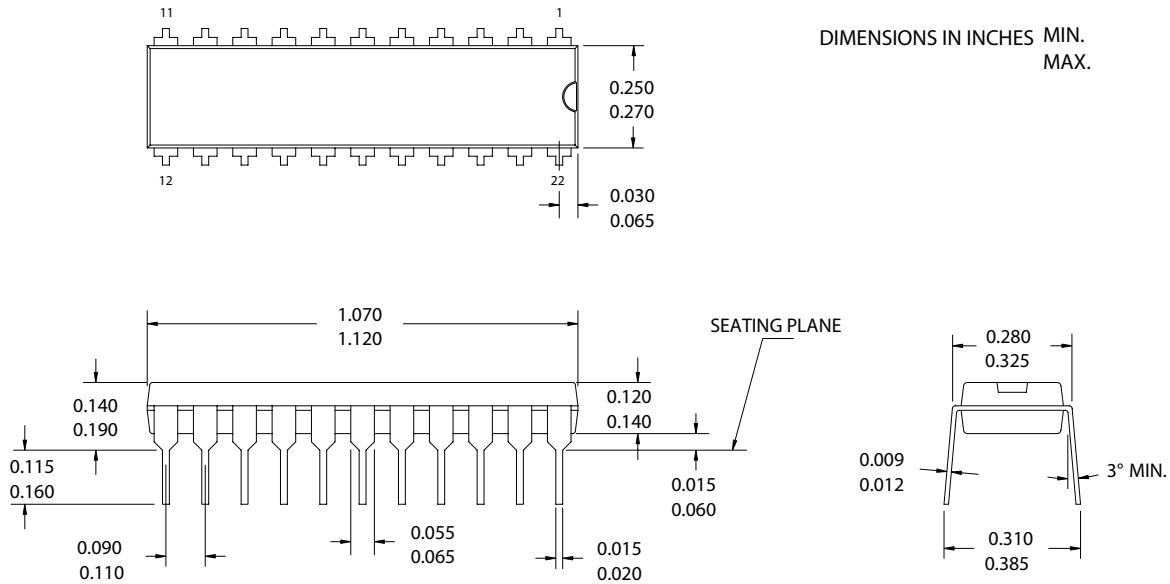

51-85012-\*A

**Package Diagrams (Continued)**

**24-pin (300-mil) SOJ (51-85030)**

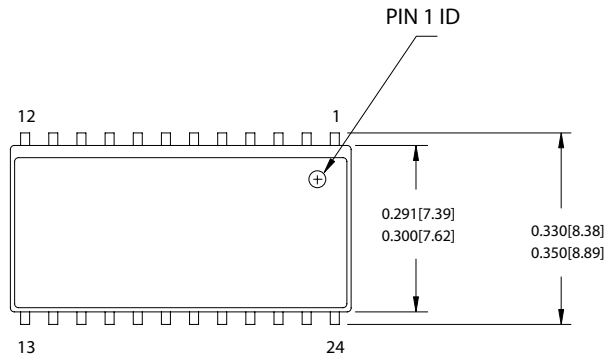

DIMENSIONS IN INCHES[MM]

MIN.  
MAX.

REFERENCE JEDEC MO-088

PACKAGE WEIGHT 0.75gms

PART #	
V24.3	STANDARD PKG.
VZ24.3	LEAD FREE PKG.

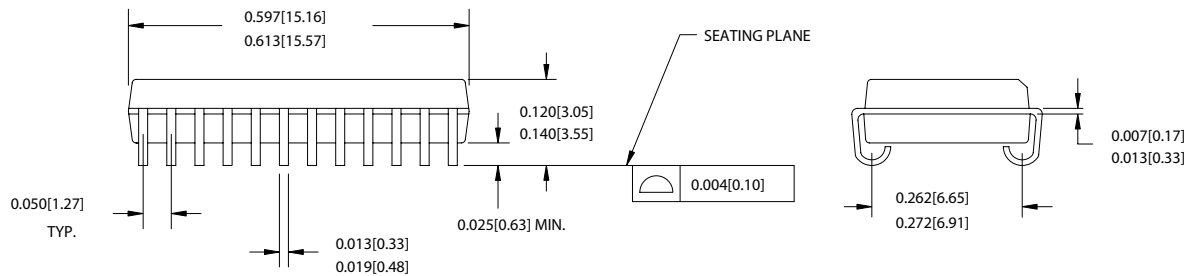

51-85030-B

All products and company names mentioned in this document may be the trademarks of their respective holders.



**Document History Page**

<b>Document Title: CY7C187 64K x 1 Static RAM</b> <b>Document Number: 38-05044</b>				
REV.	ECN NO.	Issue Date	Orig. of Change	Description of Change
**	107146	09/10/01	SZV	Change from Spec number: 38-00038 to 38-05044
*A	486744	See ECN	NXR	Removed 20 ns speed bin Changed Low standby power from 220mW to 110mW Changed the description of I <sub>IX</sub> from Input Load Current to Input Leakage Current in DC Electrical Characteristics table Updated the Ordering Information Table