

P-Channel 30-V (D-S) MOSFETs

PRODUCT SUMMARY				
Part Number	$V_{(BR)DSS}$ Min (V)	$r_{DS(on)}$ Max (Ω)	$V_{GS(th)}$ (V)	I_D (A)
VP0300L	-30	2.5 @ $V_{GS} = -12$ V	-2 to -4.5	-0.32
VP0300LS		2.5 @ $V_{GS} = -12$ V	-2 to -4.5	-0.5
VQ2001J		2 @ $V_{GS} = -12$ V	-2 to -4.5	-0.6
VQ2001P		2 @ $V_{GS} = -12$ V	-2 to -4.5	-0.6

FEATURES

- High-Side Switching
- Low On-Resistance: 1.5 Ω
- Moderate Threshold: -3.1 V
- Fast Switching Speed: 17 ns
- Low Input Capacitance: 60 pF

BENEFITS

- Ease in Driving Switches
- Low Offset (Error) Voltage
- Low-Voltage Operation
- High-Speed Switching
- Easily Driven Without Buffer

APPLICATIONS

- Drivers: Relays, Solenoids, Lamps, Hammers, Displays, Memories, Transistors, etc.
- Battery Operated Systems
- Power Supply, Converter Circuits
- Motor Control

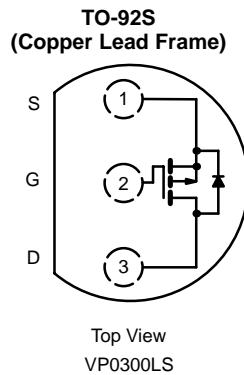
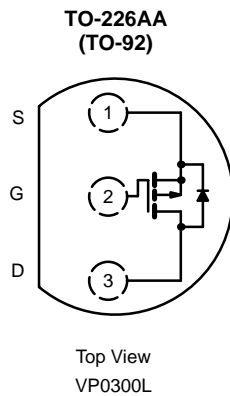

For device marking, see the last page of this data sheet.

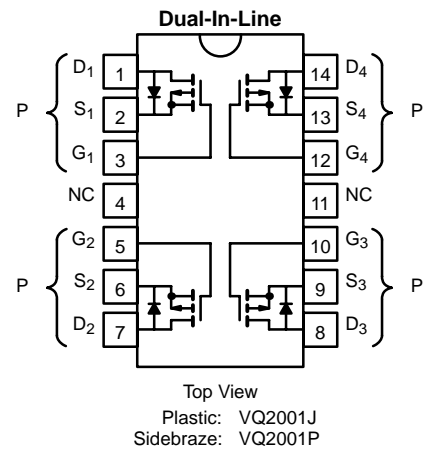

ABSOLUTE MAXIMUM RATINGS ($T_A = 25^\circ\text{C}$ UNLESS OTHERWISE NOTED)							
Parameter	Symbol	VP0300L	VP0300LS	VQ2001J/P		Unit	
				Single	Total Quad		
Drain-Source Voltage	V_{DS}	-30	-30	-30	-30	V	
Gate-Source Voltage	V_{GS}	± 20	± 20	± 20	± 20	V	
Continuous Drain Current ($T_J = 150^\circ\text{C}$)	$T_A = 25^\circ\text{C}$	I_D	-0.32	-0.5	-0.6	-0.6	A
	$T_A = 100^\circ\text{C}$		-0.2	-0.32	-0.37	-0.37	
Pulsed Drain Current ^a	I_{DM}	-2.4	-3	-2	-2	A	
Power Dissipation	$T_A = 25^\circ\text{C}$	P_D	0.8	0.9	1.3	2	W
	$T_A = 100^\circ\text{C}$		0.32	0.4	0.52	0.8	
Thermal Resistance, Junction-to-Ambient	R_{thJA}	156	139	96	62.5	$^\circ\text{C/W}$	
Operating Junction and Storage Temperature Range	T_J, T_{stg}	-55 to 150				$^\circ\text{C}$	

Notes

a. Pulse width limited by maximum junction temperature.

For applications information see AN804.

SPECIFICATIONS (T _A = 25 °C UNLESS OTHERWISE NOTED)								
Parameter	Symbol	Test Conditions	Typ ^a	Limits				Unit
				VP0300L/LS		VQ2001J/P		
				Min	Max	Min	Max	
Static								
Drain-Source Breakdown Voltage	V _{(BR)DSS}	V _{GS} = 0 V, I _D = -10 μA	-55	-30		-30		V
Gate-Threshold Voltage	V _{GS(th)}	V _{DS} = V _{GS} , I _D = -1 mA	-3.1	-2	-4.5	-2	-4.5	
Gate-Body Leakage	I _{GSS}	V _{DS} = 0 V, V _{GS} = ±16 V					±100	nA
		T _J = 125°C					±500	
		V _{DS} = 0 V, V _{GS} = ±20 V			±100			
Zero Gate Voltage Drain Current	I _{DSS}	V _{DS} = -24 V, V _{GS} = 0 V			-10			μA
		T _J = 125°C			-500		-500	
		V _{DS} = -30 V, V _{GS} = 0 V					-10	
On-State Drain Current ^b	I _{D(on)}	V _{DS} = -10 V, V _{GS} = -12 V	-2.8	-1.5		-1.5		A
Drain-Source On-Resistance ^b	r _{DS(on)}	V _{GS} = -12 V, I _D = -1 A	1.5		2.5		2	Ω
		T _J = 125°C	2.6		3.6		3.6	
Forward Transconductance ^b	g _{fs}	V _{DS} = -10 V, I _D = -0.5 A	370	200		200		mS
Common Source Output Conductance ^b	g _{os}	V _{DS} = -7.5 V, I _D = -0.05 A	0.25					
Dynamic								
Input Capacitance	C _{iss}	V _{DS} = -15 V, V _{GS} = 0 V f = 1 MHz	60		150		150	pF
Output Capacitance	C _{oss}		40		100		100	
Reverse Transfer Capacitance	C _{rss}		10		60		60	
Switching^c								
Turn-On Time	t _{ON}	V _{DD} = -25 V, R _L = 23 Ω I _D ≅ -1 A, V _{GEN} = -10 V R _G = 25 Ω	19		30			ns
Turn-Off Time	t _{OFF}		17		30			
Turn-On Time	t _{ON}	V _{DD} = -15 V, R _L = 23 Ω I _D ≅ -0.6 A, V _{GEN} = -10 V R _G = 25 Ω	19				30	
Turn-Off Time	t _{OFF}		16				30	

Notes

- a. For DESIGN AID ONLY, not subject to production testing.
- b. Pulse test: PW ≤ 300 μs duty cycle ≤ 2%.
- c. Switching time is essentially independent of operating temperature.

VPEA03



TYPICAL CHARACTERISTICS ($T_A = 25^\circ\text{C}$ UNLESS OTHERWISE NOTED)

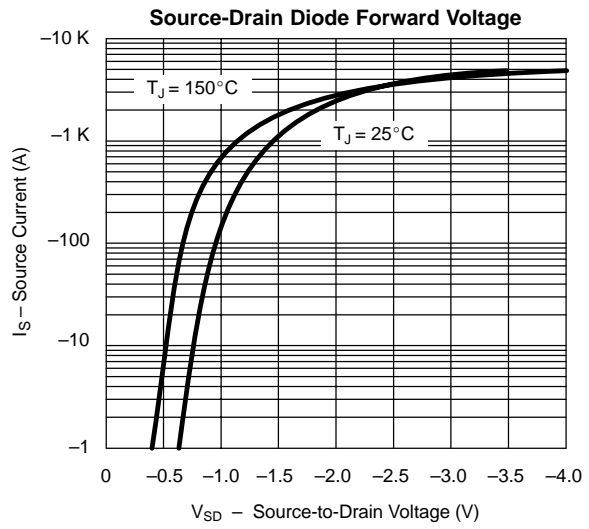
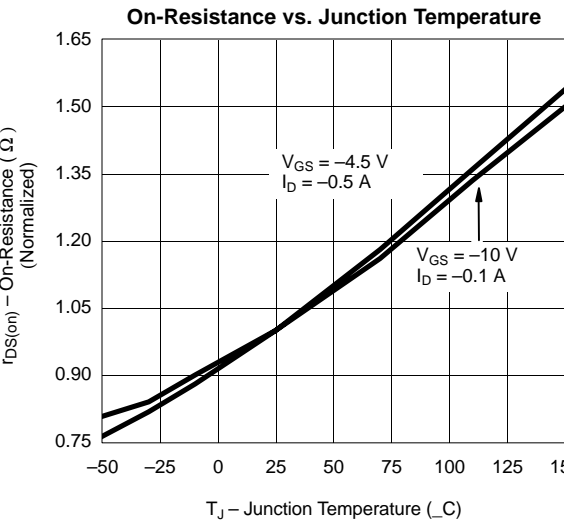
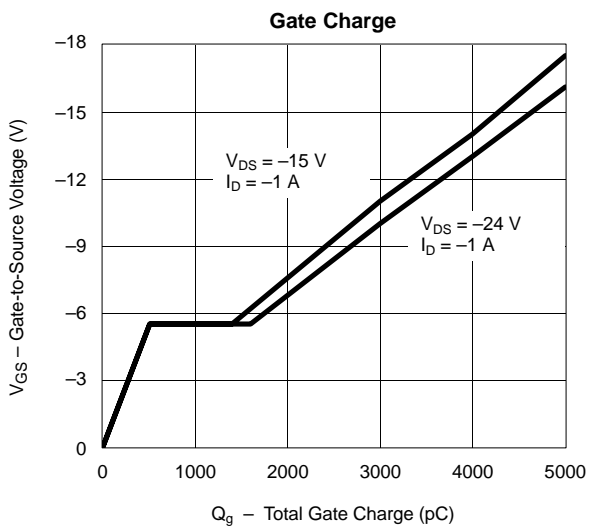
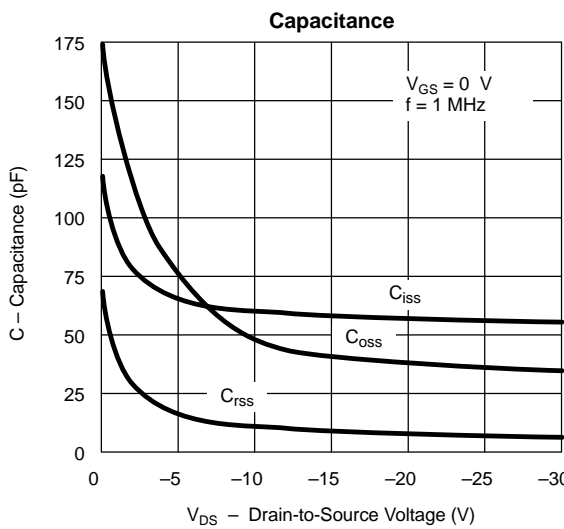
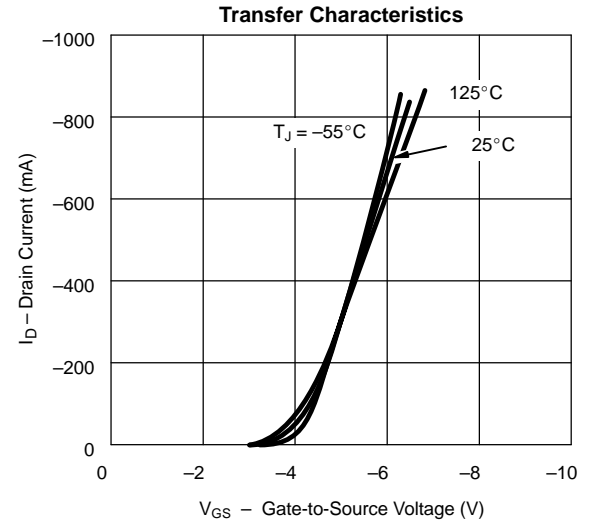
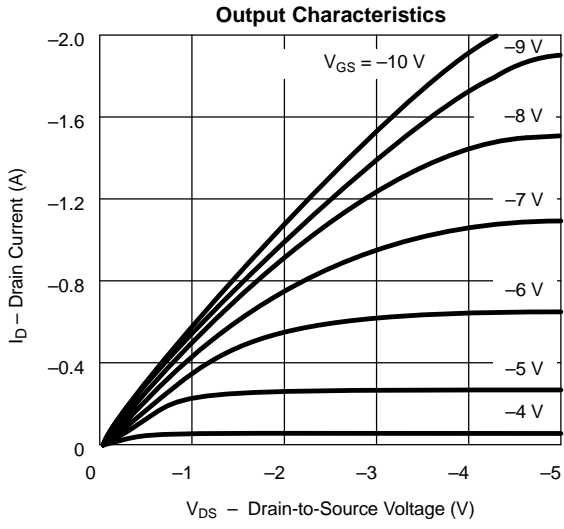

TYPICAL CHARACTERISTICS ($T_A = 25^\circ\text{C}$ UNLESS OTHERWISE NOTED)

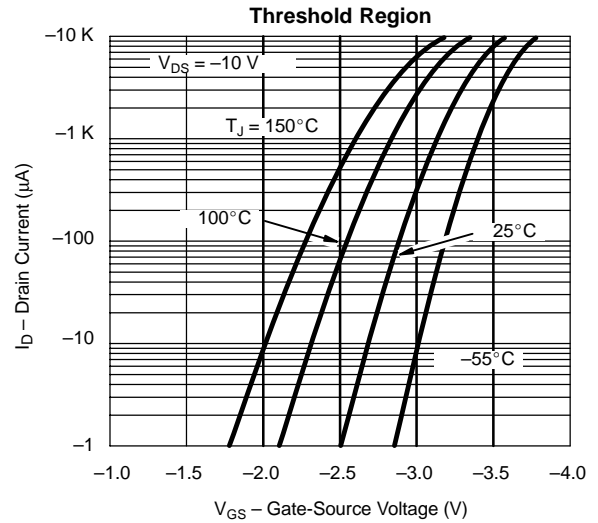
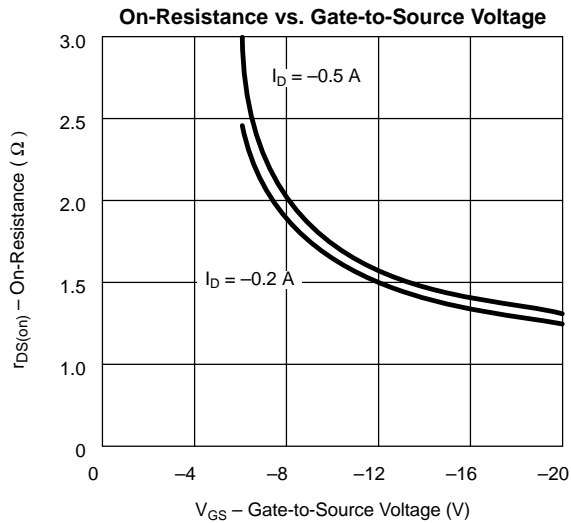

THERMAL RATINGS

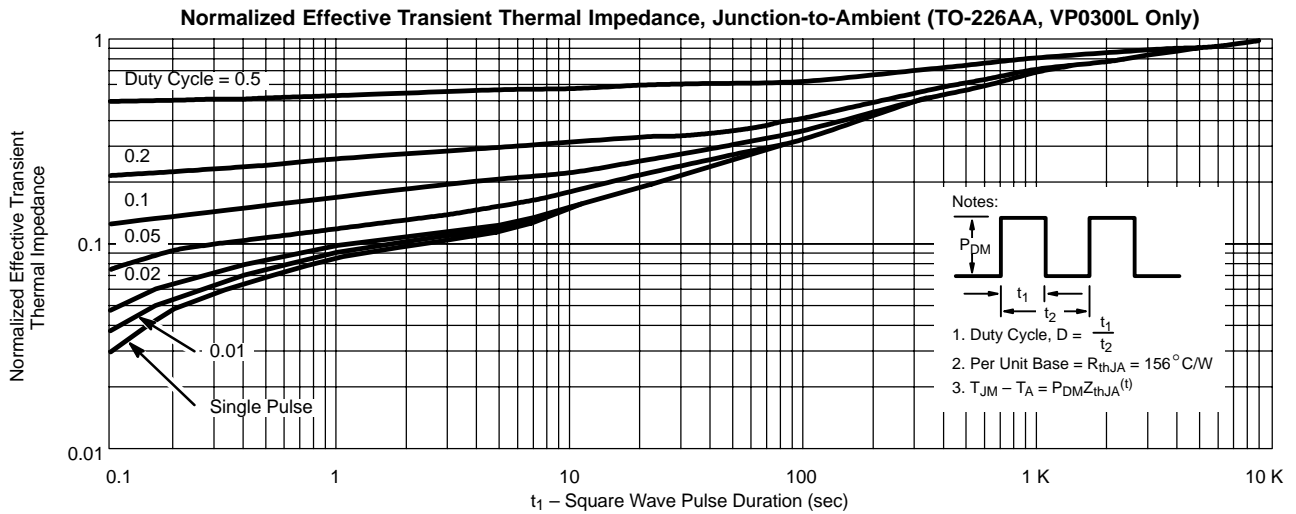

DEVICE MARKINGS

Front View:

VP0300L

"S" VP
0300L
xxyy

VP0300LS

"S" VP
0300LS
xxyy

Top View:

VQ2001J

VQ2001J
"S" f//xxyy

VP0300LS

VQ2001P
"S" f//xxyy

"S" = Siliconix Logo
f = Factory Code
// = Lot Traceability
xxyy = Date Code



Disclaimer

All product specifications and data are subject to change without notice.

Vishay Intertechnology, Inc., its affiliates, agents, and employees, and all persons acting on its or their behalf (collectively, "Vishay"), disclaim any and all liability for any errors, inaccuracies or incompleteness contained herein or in any other disclosure relating to any product.

Vishay disclaims any and all liability arising out of the use or application of any product described herein or of any information provided herein to the maximum extent permitted by law. The product specifications do not expand or otherwise modify Vishay's terms and conditions of purchase, including but not limited to the warranty expressed therein, which apply to these products.

No license, express or implied, by estoppel or otherwise, to any intellectual property rights is granted by this document or by any conduct of Vishay.

The products shown herein are not designed for use in medical, life-saving, or life-sustaining applications unless otherwise expressly indicated. Customers using or selling Vishay products not expressly indicated for use in such applications do so entirely at their own risk and agree to fully indemnify Vishay for any damages arising or resulting from such use or sale. Please contact authorized Vishay personnel to obtain written terms and conditions regarding products designed for such applications.

Product names and markings noted herein may be trademarks of their respective owners.