

DS2001/DS9665/DS2002/DS9666 DS2003/DS9667/DS2004/DS9668 High Current/Voltage Darlington Drivers

General Description

The DS2001/DS9665/DS2002/DS9666/DS2003/DS9667/DS2004/DS9668 are comprised of seven high voltage, high current NPN Darlington transistor pairs. All units feature common emitter, open collector outputs. To maximize their effectiveness, these units contain suppression diodes for inductive loads and appropriate emitter base resistors for leakage.

The DS2001/DS9665 is a general purpose array which may be used with DTL, TTL, PMOS, CMOS, etc. Input current limiting is done by connecting an appropriate discrete resistor to each input.

The DS2002/DS9666 version does away with the need for any external discrete resistors, since each unit has a resistor and a Zener diode in series with the input. The DS2002/DS9666 was specifically designed for direct interface from PMOS logic (operating at supply voltages from 14V to 25V) to solenoids or relays.

The DS2003/DS9667 has a series base resistor to each Darlington pair, thus allowing operation directly with TTL or CMOS operating at supply voltages of 5.0V.

The DS2004/DS9668 has an appropriate input resistor to allow direct operation from CMOS or PMOS outputs operating from supply voltages of 6.0V to 15V.

The DS2001/DS9665/DS2002/DS9666/DS2003/DS9667/DS2004/DS9668 offer solutions to a great many interface needs, including solenoids, relays, lamps, small motors, and LEDs. Applications requiring sink currents beyond the capability of a single output may be accommodated by paralleling the outputs.

Features

- Seven high gain Darlington pairs
- High output voltage ($V_{CE} = 50V$)
- High output current ($I_C = 350\text{ mA}$)
- DTL, TTL, PMOS, CMOS compatible
- Suppression diodes for inductive loads
- Extended temperature range

DS2001/DS9665/DS2002/DS9666/DS2003/DS9667/DS2004/DS9668

Connection Diagram

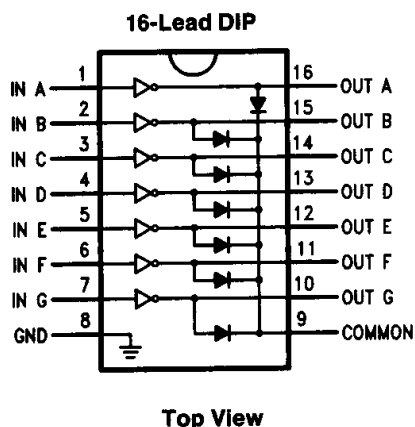

Order Numbers

	J Package Number J16A	N Package Number N16E	M Package Number M16A
DS2001 DS9665	DS2001MJ DS2001TJ DS2001CJ DS9665MJ DS9665TJ DS9665CJ	DS2001TN DS2001CN DS9665TN DS9665CN	DS2001TM DS2001CM
DS2002 DS9666	DS2002MJ DS2002TJ DS2002CJ DS9666MJ DS9666TJ DS9666CJ	DS2002TN DS2002CN DS9666TN DS9666CN	DS2002TM DS2002CM
DS2003 DS9667	DS2003MJ DS2003TJ DS2003CJ DS9667MJ DS9667TJ DS9667CJ	DS2003TN DS2003CN DS9667TN DS9667CN	DS2003TM DS2003CM
DS2004 DS9668	DS2004MJ DS2004TJ DS2004CJ DS9668MJ DS9668TJ DS9668CJ	DS2004TN DS2004CN DS9668TN DS9668CN	DS2004TM DS2004CM

Absolute Maximum Ratings (Note 1)

If Military/Aerospace specified devices are required, please contact the National Semiconductor Sales Office/Distributors for availability and specifications.

Storage Temperature Range	
Ceramic DIP	-65°C to +175°C
Molded DIP	-65°C to +150°C
Operating Temperature Range	
DS2001M/DS9665M	-55°C to +125°C
DS2002M/DS9666M	-55°C to +125°C
DS2003M/DS9667M	-55°C to +125°C
DS2004M/DS9668M	-55°C to +125°C
DS2001T/DS9665T	-40°C to +105°C
DS2002T/DS9666T	-40°C to +105°C
DS2003T/DS9667T	-40°C to +105°C
DS2004T/DS9668T	-40°C to +105°C

DS2001C/DS9665C	0°C to +85°C
DS2002C/DS9666C	0°C to +85°C
DS2003C/DS9667C	0°C to +85°C
DS2004C/DS9668C	0°C to +85°C

Lead Temperature	
Ceramic DIP (Soldering, 60 seconds)	300°C
Molded DIP (Soldering, 10 seconds)	265°C

Maximum Power Dissipation* at 25°C	
Cavity Package	2016 mW
Molded Package	1838 mW
S.O. Package	926 mW

*Derate cavity package 16.13 mW/°C above 25°C; derate molded DIP package 14.7 mW/°C above 25°C. Derate S.O. package 7.4 mW/°C.

Input Voltage	30V
Output Voltage	55V
Emitter-Base Voltage	6.0V
Continuous Collector Current	500 mA
Continuous Base Current	25 mA

Electrical Characteristics $T_A = 25^\circ\text{C}$, unless otherwise specified (Note 2)

Symbol	Parameter	Conditions	Min	Typ	Max	Units
I_{CEX}	Output Leakage Current	$T_A = 85^\circ\text{C}$ for Commercial $V_{CE} = 50\text{V}$ (Figure 1a)			100	μA
		$V_{CE} = 50\text{V}$, $V_I = 6.0\text{V}$ (Figure 1b)	DS2002/DS9666		500	
		$V_{CE} = 50\text{V}$, $V_I = 1.0\text{V}$ (Figure 1b)	DS2004/DS9668		500	
$V_{CE(Sat)}$	Collector-Emitter Saturation Voltage	$I_C = 350\text{ mA}$, $I_B = 500\ \mu\text{A}$ (Figure 2) (Note 3)		1.25	1.6	V
		$I_C = 200\text{ mA}$, $I_B = 350\ \mu\text{A}$ (Figure 2)		1.1	1.3	
		$I_C = 100\text{ mA}$, $I_B = 250\ \mu\text{A}$ (Figure 2)		0.9	1.1	
$I_{I(ON)}$	Input Current	$V_I = 17\text{V}$ (Figure 3)	DS2002/DS9666	0.85	1.3	mA
		$V_I = 3.85\text{V}$ (Figure 3)	DS2003/DS9667	0.93	1.35	
		$V_I = 5.0\text{V}$ (Figure 3)	DS2004/DS9668	0.35	0.5	
		$V_I = 12\text{V}$ (Figure 3)		1.0	1.45	
$I_{I(OFF)}$	Input Current (Note 4)	$T_A = 85^\circ\text{C}$ for Commercial $I_C = 500\ \mu\text{A}$ (Figure 4)	50	100		μA
$V_{I(ON)}$	Input Voltage (Note 5)	$V_{CE} = 2.0\text{V}$, $I_C = 300\text{ mA}$ (Figure 5)	DS2002/DS9666		13	V
		$V_{CE} = 2.0\text{V}$, $I_C = 200\text{ mA}$ (Figure 5)	DS2003/DS9667		2.4	
		$V_{CE} = 2.0\text{V}$, $I_C = 250\text{ mA}$ (Figure 5)			2.7	
		$V_{CE} = 2.0\text{V}$, $I_C = 300\text{ mA}$ (Figure 5)			3.0	
		$V_{CE} = 2.0\text{V}$, $I_C = 125\text{ mA}$ (Figure 5)	DS2004/DS9668		5.0	
		$V_{CE} = 2.0\text{V}$, $I_C = 200\text{ mA}$ (Figure 5)			6.0	
		$V_{CE} = 2.0\text{V}$, $I_C = 275\text{ mA}$ (Figure 5)			7.0	
		$V_{CE} = 2.0\text{V}$, $I_C = 350\text{ mA}$ (Figure 5)			8.0	
h_{FE}	DC Forward Current Transfer Ratio	$V_{CE} = 2.0\text{V}$, $I_C = 350\text{ mA}$ (Figure 2)	DS2001/DS9665	1000		
C_I	Input Capacitance			15	30	pF
t_{PLH}	Turn-On Delay	$0.5 V_I$ to $0.5 V_O$			1.0	μs
t_{PHL}	Turn-Off Delay	$0.5 V_I$ to $0.5 V_O$			1.0	μs
I_R	Clamp Diode Leakage Current	$V_R = 50\text{V}$ (Figure 6)	$T_A = 25^\circ\text{C}$		50	μA
			$T_A = 85^\circ\text{C}$		100	
V_F	Clamp Diode Forward Voltage	$I_F = 350\text{ mA}$ (Figure 7)		1.7	2.0	V

Note 1: "Absolute Maximum Ratings" are those values beyond which the safety of the device cannot be guaranteed. They are not meant to imply that the devices should be operated at these limits. The tables of "Electrical Characteristics" provide conditions for actual device operation.

Note 2: All limits apply to the complete Darlington series except as specified for a single device type.

Note 3: Under normal operating conditions these units will sustain 350 mA per output with $V_{CE(Sat)} = 1.6\text{V}$ at 70°C with a pulse width of 20 ms and a duty cycle of 30%.

Note 4: The $I_{I(OFF)}$ current limit guaranteed against partial turn-on of the output.

Note 5: The $V_{I(ON)}$ voltage limit guarantees a minimum output sink current per the specified test conditions.

Typical Performance Characteristics

DS2001/DS9665/DS2002/DS9666/DS2003/DS9667/DS2004/DS9668

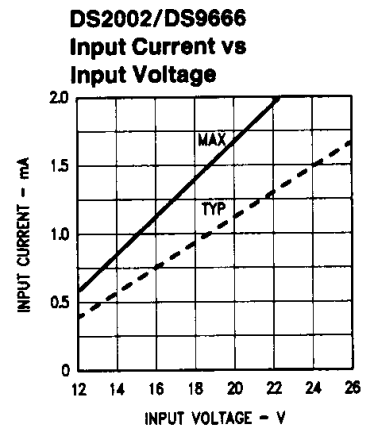
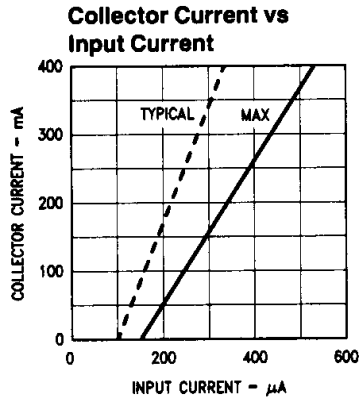
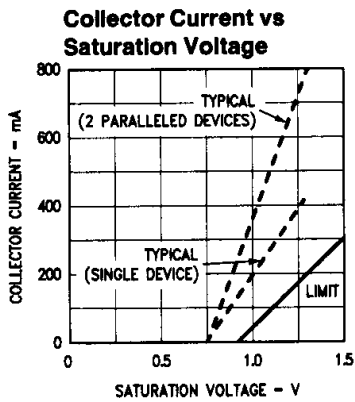

TL/F/9647-6

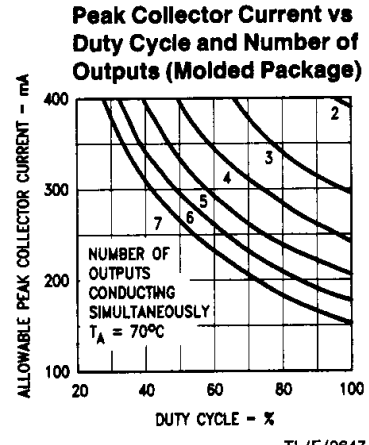
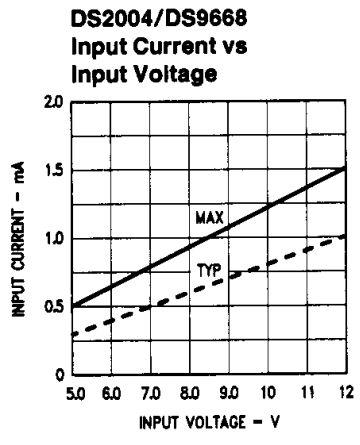
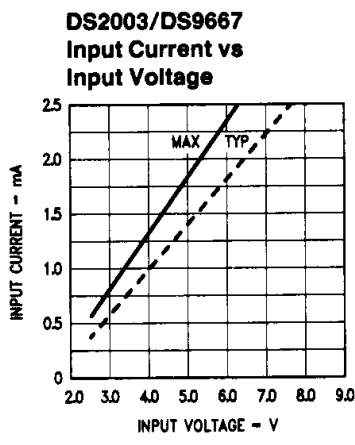

TL/F/9647-18

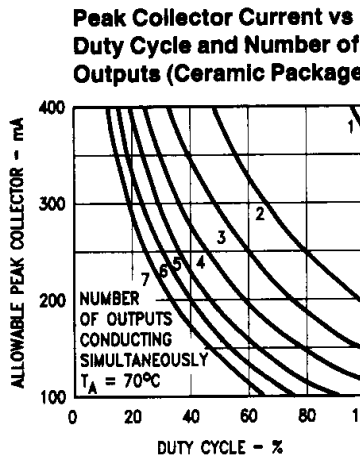

TL/F/9647-19

Equivalent Circuits

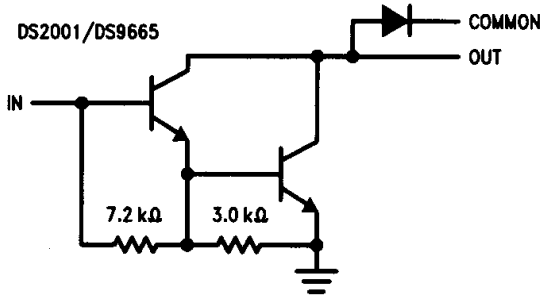

TL/F/9647-2

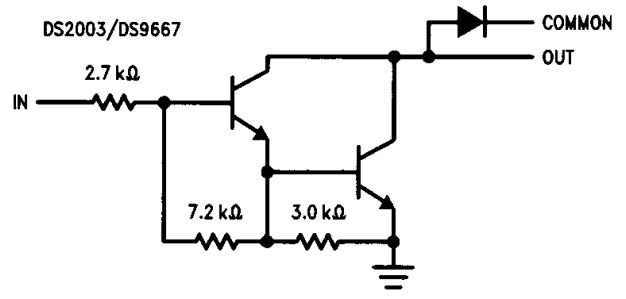

TL/F/9647-3

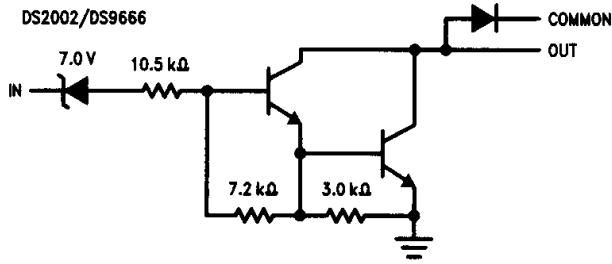

TL/F/9647-4

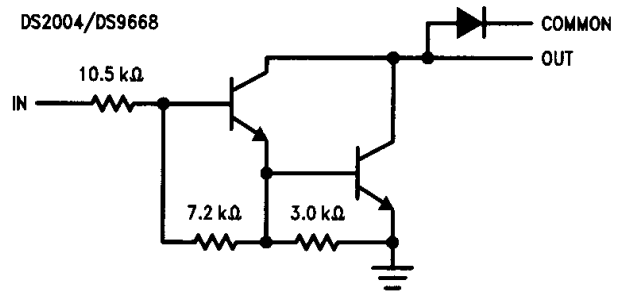

TL/F/9647-5

Test Circuits

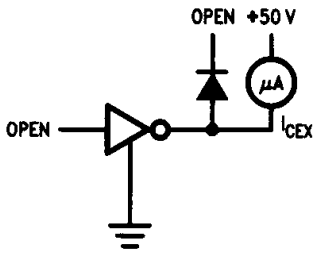

TL/F/9647-7

FIGURE 1a

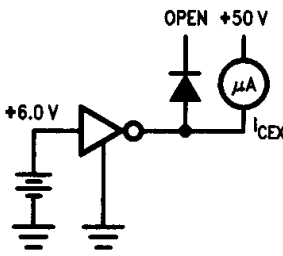

TL/F/9647-8

FIGURE 1b

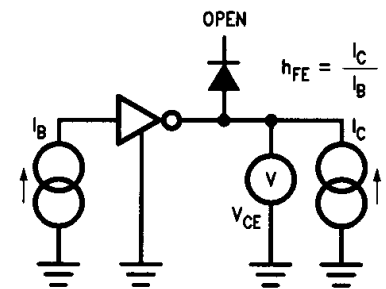

TL/F/9647-9

FIGURE 2

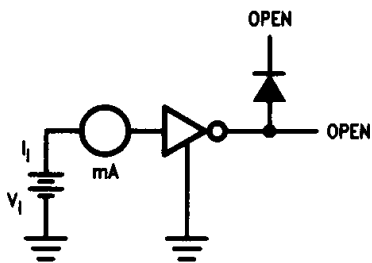

TL/F/9647-10

FIGURE 3

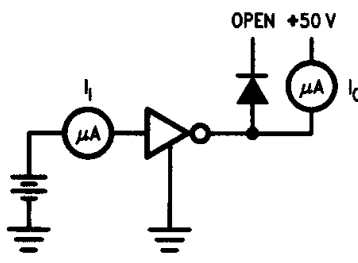

TL/F/9647-11

FIGURE 4

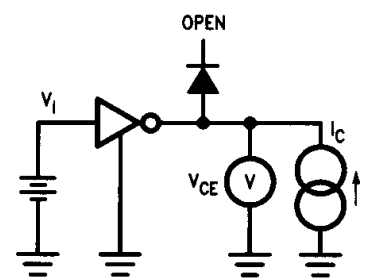

TL/F/9647-12

FIGURE 5

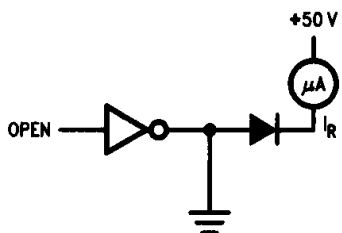

TL/F/9647-13

FIGURE 6

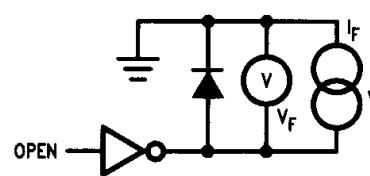

TL/F/9647-14

FIGURE 7

Typical Applications

DS2001/DS9665/DS2002/DS9666/DS2003/DS9667/DS2004/DS9668

