

SD5000/5400 Series

N-Channel Lateral DMOS FETs

SD5000I
SD5000N
SD5001N

SD5400CY
SD5401CY

Product Summary

Part Number	$V_{(BR)DS}$ Min (V)	$V_{GS(th)}$ Max (V)	$r_{DS(on)}$ Max (Ω)	C_{rss} Max (pF)	t_{ON} Max (ns)
SD5000I	20	1.5	70 @ $V_{GS} = 5$ V	0.5	2
SD5000N	20	1.5	70 @ $V_{GS} = 5$ V	0.5	2
SD5001N	10	1.5	70 @ $V_{GS} = 5$ V	0.5	2
SD5400CY	20	1.5	75 @ $V_{GS} = 5$ V	0.5	2
SD5401CY	10	1.5	75 @ $V_{GS} = 5$ V	0.5	2

Features

- Quad SPST Switch with Zener Input Protection
- Low Interelectrode Capacitance and Leakage
- Ultra-High Speed Switching— t_{ON} : 1 ns
- Ultra-Low Reverse Capacitance: 0.2 pF
- Low Guaranteed r_{DS} @ 5 V
- Low Turn-On Threshold Voltage

Benefits

- High-Speed System Performance
- Low Insertion Loss at High Frequencies
- Low Transfer Signal Loss
- Simple Driver Requirement
- Single Supply Operation

Applications

- Fast Analog Switch
- Fast Sample-and-Holds
- Pixel-Rate Switching
- Video Switch
- Multiplexer
- DAC Deglitchers
- High-Speed Driver

Description

The SD5000/5400 series of monolithic switches features four individual double-diffused enhancement-mode MOSFETs built on a common substrate. These bidirectional devices provide low on-resistance and low interelectrode capacitances to minimize insertion loss and crosstalk.

manufacturing reliability, these devices feature poly-silicon gates protected by Zener diodes.

The SD5000/5400 are rated to handle ± 10 -V analog signals, while the SD5001/5401 are rated for ± 5 -V signals.

Built on Siliconix' proprietary DMOS process, the SD5000/5400 series utilizes lateral construction to achieve low capacitance and ultra-fast switching speeds. For

For similar products packaged in TO-206AF (TO-72) and TO-253 (SOT-143) see the SD211DE/SST211 series.

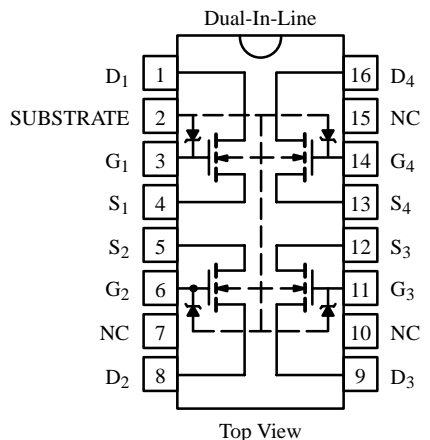

Plastic: SD5000N
SD5001N
Sidebrazed: SD5000I

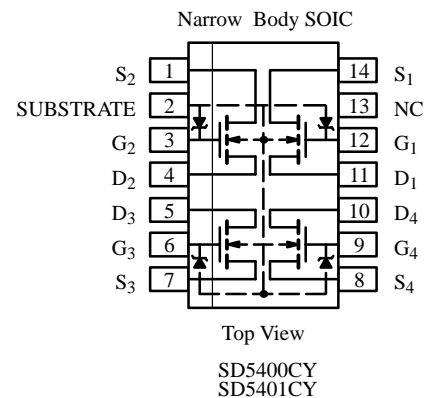

Updates to this data sheet may be obtained via facsimile by calling Siliconix FaxBack, 1-408-970-5600. Please request FaxBack document #70296. Applications information may also be obtained via FaxBack, request document #70607.

SD5000/5400 Series

Absolute Maximum Ratings ($T_A = 25^\circ\text{C}$ Unless Otherwise Noted)

Gate-Drain, Gate-Source Voltage (SD5000, SD5400) +30 V/–25 V (SD5001, SD5401) +25 V/–15 V	Drain Current 50 mA
Gate-Substrate Voltage (SD5000, SD5400) +30 V/–0.3 V (SD5001, SD5401) +25 V/–0.3 V	Lead Temperature ($1/16''$ from case for 10 seconds) 300°C
Drain-Source Voltage (SD5000, SD5400) 20 V (SD5001, SD5401) 10 V	Storage Temperature -65 to 150°C
Drain-Source-Substrate Voltage (SD5000, SD5400) 25 V (SD5001, SD5401) 15 V	Operating Junction Temperature -55 to 150°C
	Power Dissipation ^{a, b} : (Package) 500 mW (Each Device) 300 mW

Notes:
a. SD5000/SD5001 derate 5 mW/ $^\circ\text{C}$ above 25°C
b. SD5400/SD5401 derate 4 mW/ $^\circ\text{C}$ above 25°C

Specifications^a

Parameter	Symbol ^b	Test Conditions ^b	Typ ^c	Limits				Unit	
				SD5000 SD5400		SD5001 SD5401			
				Min	Max	Min	Max		
Static									
Drain-Source Breakdown Voltage	$V_{(BR)DS}$	$V_{GS} = V_{BS} = -5\text{ V}$, $I_D = 10\text{ nA}$	30	20		10		V	
Source-Drain Breakdown Voltage	$V_{(BR)SD}$	$V_{GD} = V_{BD} = -5\text{ V}$, $I_S = 10\text{ nA}$	22	20		10			
Drain-Substrate Breakdown Voltage	$V_{(BR)DBO}$	$V_{GB} = 0\text{ V}$, $I_D = 10\text{ nA}$, Source Open	35	25		15			
Source-Substrate Breakdown Voltage	$V_{(BR)SBO}$	$V_{GB} = 0\text{ V}$, $I_S = 10\text{ }\mu\text{A}$, Drain Open	35	25		15			
Drain-Source Leakage	$I_{DS(off)}$	$V_{GS} = V_{BS} = -5\text{ V}$	$V_{DS} = 10\text{ V}$	0.4			10	nA	
			$V_{DS} = 15\text{ V}$	0.7					
			$V_{DS} = 20\text{ V}$	0.9		10			
Source-Drain Leakage	$I_{SD(off)}$	$V_{GD} = V_{BD} = -5\text{ V}$	$V_{SD} = 10\text{ V}$	0.5			10		
			$V_{SD} = 15\text{ V}$	0.8					
			$V_{SD} = 20\text{ V}$	1		10			
Gate Leakage	I_{GBS}	$V_{DB} = V_{SB} = 0\text{ V}$, $V_{GB} = 30\text{ V}$	0.01		100		100		
Threshold Voltage	$V_{GS(th)}$	$V_{DS} = V_{GS}$, $I_D = 1\text{ }\mu\text{A}$, $V_{SB} = 0\text{ V}$	0.8	0.1	1.5	0.1	1.5	V	
Drain-Source On-Resistance	$r_{DS(on)}$	$V_{SB} = 0\text{ V}$ $I_D = 1\text{ mA}$	SD5000 Series $V_{GS} = 5\text{ V}$	58		70		70	Ω
			SD5400 Series $V_{GS} = 5\text{ V}$	60		75		75	
			$V_{GS} = 10\text{ V}$	38					
			$V_{GS} = 15\text{ V}$	30					
			$V_{GS} = 20\text{ V}$	26					
Resistance Match	$\Delta r_{DS(on)}$		$V_{GS} = 5\text{ V}$	1		5		5	
Dynamic									
Forward Transconductance	g_{fs}	$V_{DS} = 10\text{ V}$ $V_{SB} = 0\text{ V}$ $I_D = 20\text{ mA}$ $f = 1\text{ kHz}$	SD5000 Series	12	10		10		mS
			SD5400 Series	11	9		9		
Gate Node Capacitance	$C_{(GS+GD+GB)}$	$V_{DS} = 10\text{ V}$ $f = 1\text{ MHz}$ $V_{GS} = V_{BS} = -15\text{ V}$	SD5000 Series	2.5		3.5		3.5	pF
Drain Node Capacitance	$C_{(GD+DB)}$			2.0		3		3	
Source Node Capacitance	$C_{(GS+SB)}$			3.7		5		5	
Reverse Transfer Capacitance	C_{rss}			0.2		0.5		0.5	
Crosstalk		$f = 3\text{ kHz}$		-107					dB

Specifications^a

Parameter	Symbol ^b	Test Conditions ^b	Typ ^c	Limits				Unit
				SD5000 SD5400		SD5001 SD5401		
				Min	Max	Min	Max	
Switching								
Turn-On Time	$t_{d(on)}$	$V_{SB} = 5\text{ V}, V_{IN} 0\text{ to }5\text{ V}, R_G = 25\ \Omega$ $V_{DD} = 5\text{ V}, R_L = 680\ \Omega$	0.5		1		1	ns
	t_r		0.6		1		1	
Turn-Off Time	$t_{d(off)}$		2					
	t_f		6					

Notes:

- $T_A = 25^\circ\text{C}$ unless otherwise noted.
- B is the body (substrate) and $V_{(BR)}$ is breakdown.
- Typical values are for DESIGN AID ONLY, not guaranteed nor subject to production testing.

DMCA

Typical Characteristics

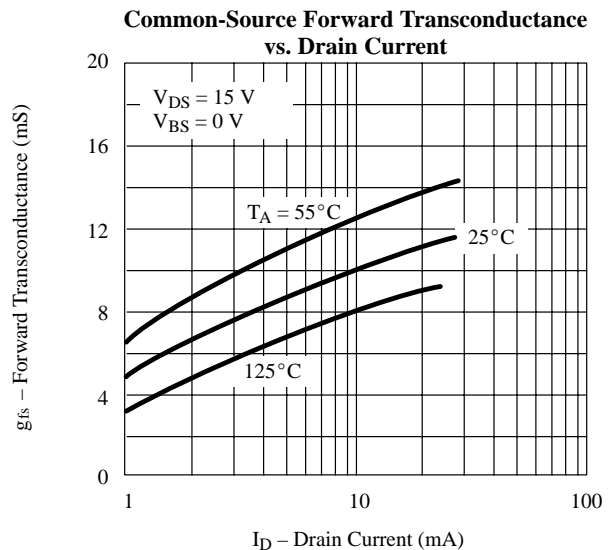
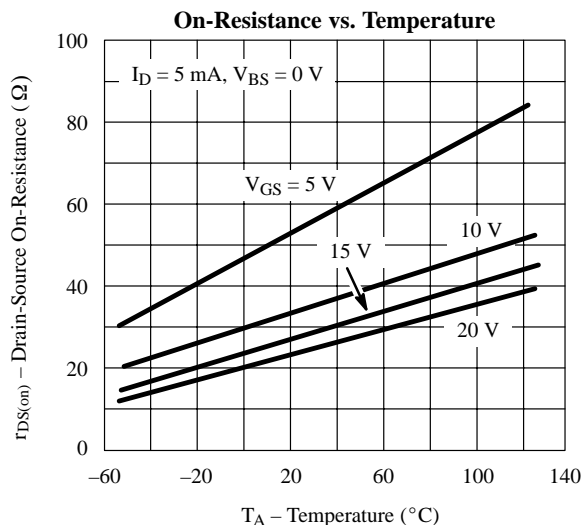
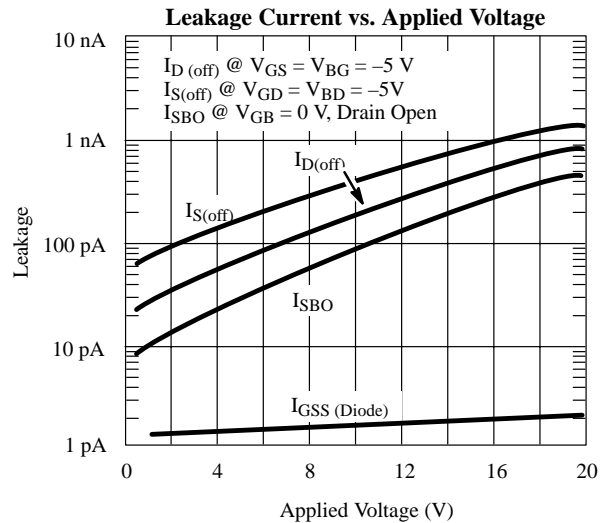
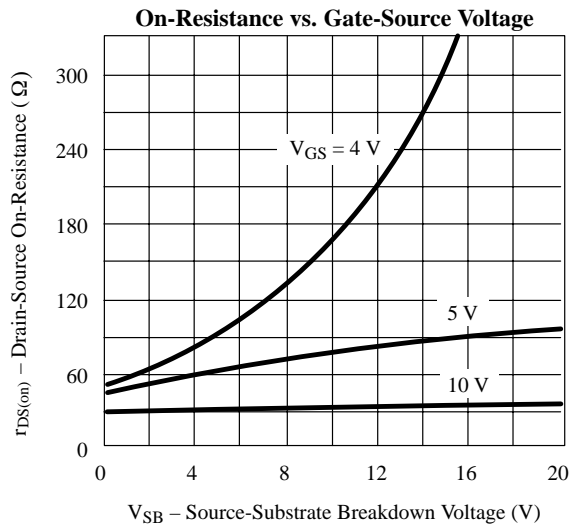

SD5000/5400 Series

Typical Characteristics (Cont'd)

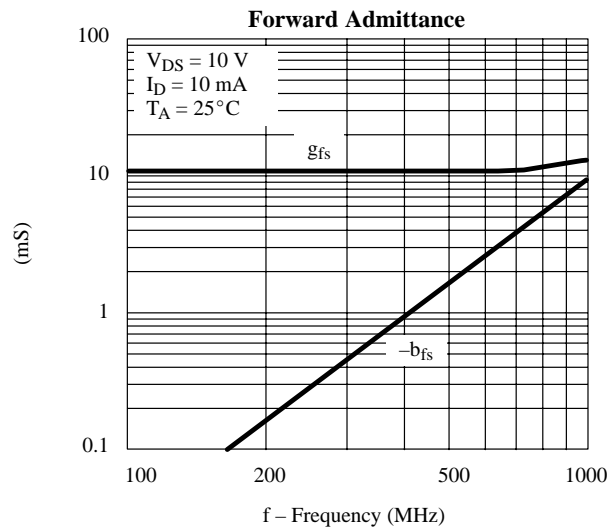
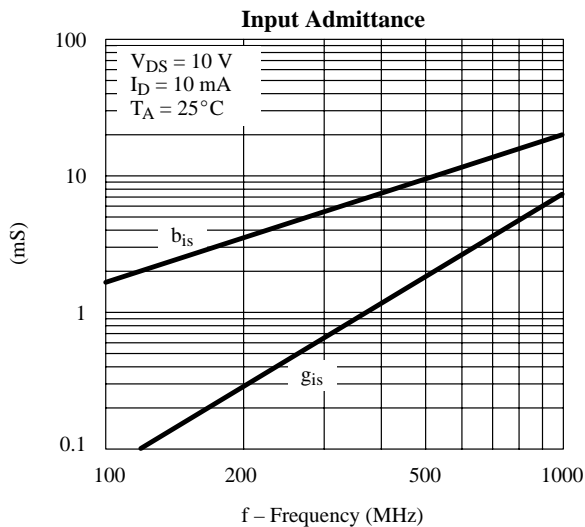
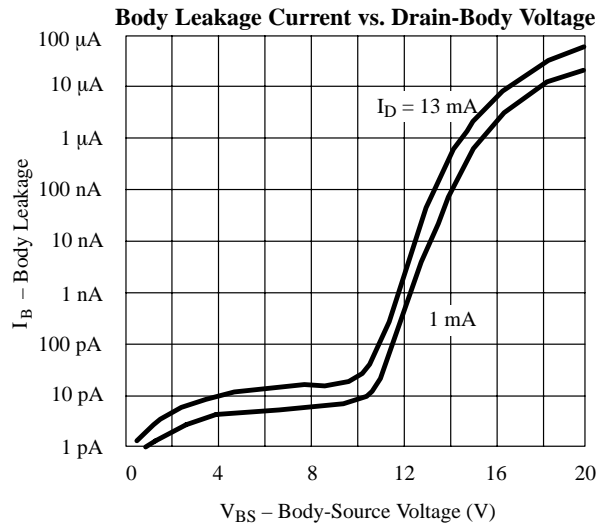
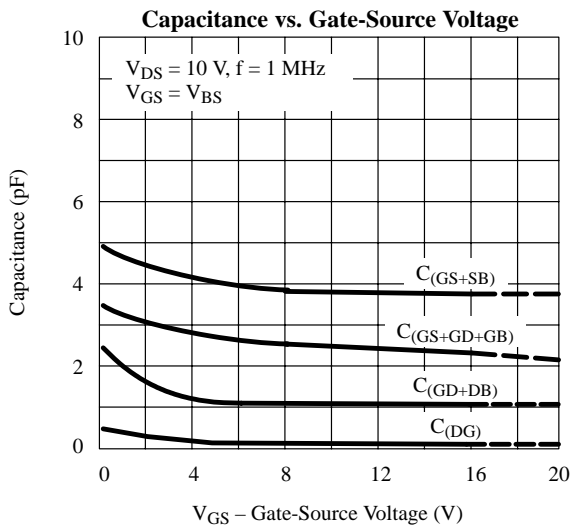
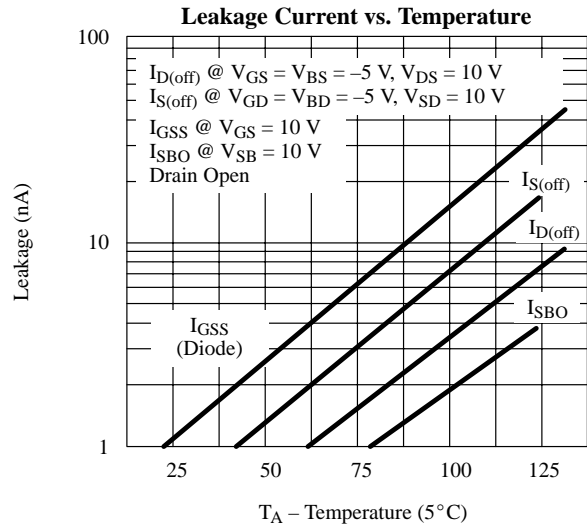
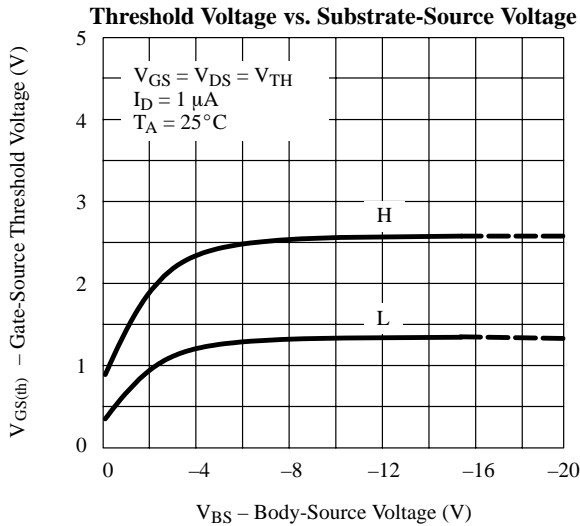

Typical Characteristics (Cont'd)

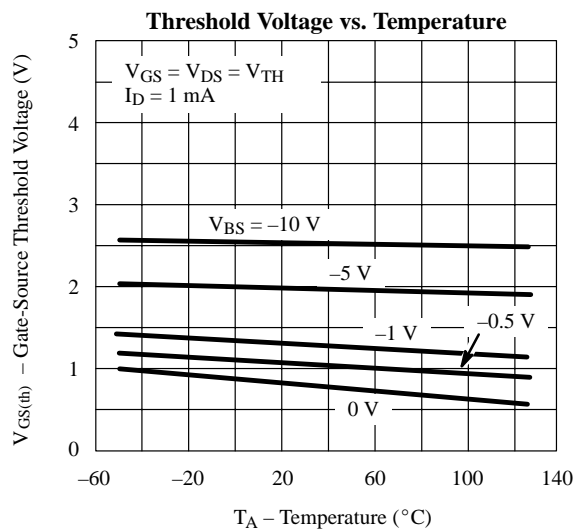
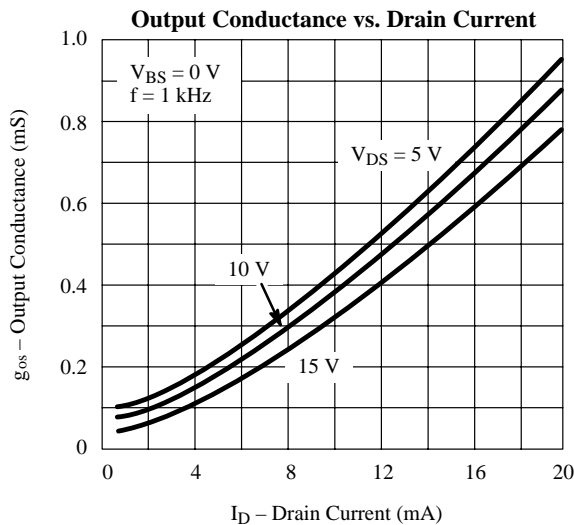
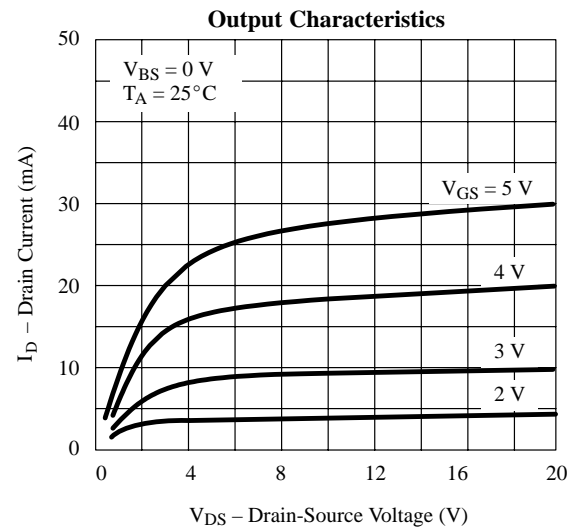
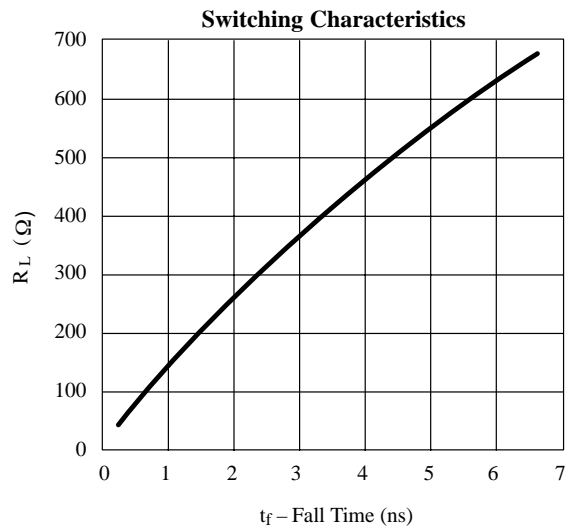
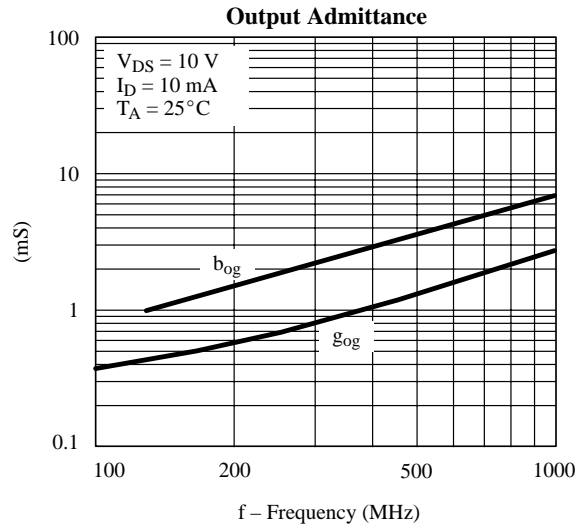
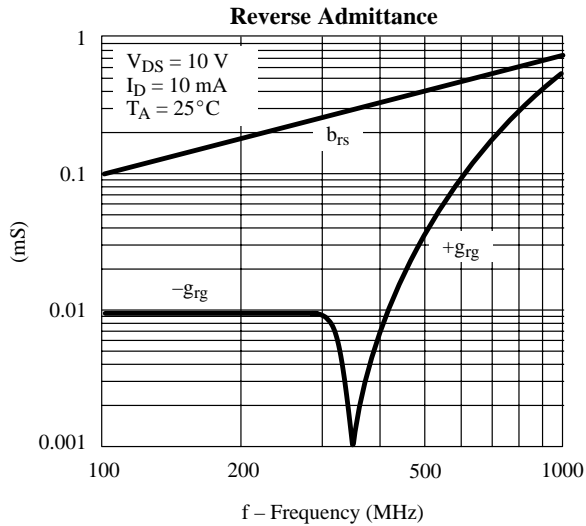

SD5000/5400 Series

Switching Time Test Circuit

