

Quad P-Channel 60-V (D-S) MOSFET

PRODUCT SUMMARY			
$V_{(BR)DSS}$ Min (V)	$r_{DS(on)}$ Max (Ω)	$V_{GS(th)}$ (V)	I_D (A)
-60	5 @ $V_{GS} = -10$ V	-2 to -4.5	-0.41

FEATURES

- High-Side Switching
- Low On-Resistance: 2.5 Ω
- Moderate Threshold: -3.4 V
- Fast Switching Speed: 40 ns
- Low Input Capacitance: 75 pF

BENEFITS

- Ease in Driving Switches
- Low Offset (Error) Voltage
- Low-Voltage Operation
- High-Speed Switching
- Easily Driven Without Buffer

APPLICATIONS

- Drivers: Relays, Solenoids, Lamps, Hammers, Displays, Memories, Transistors, etc.
- Battery Operated Systems
- Power Supply, Converter Circuits
- Motor Control

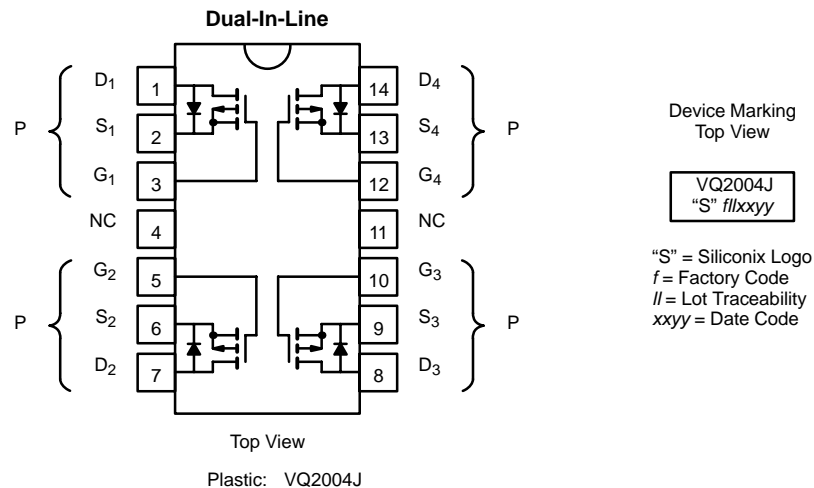

ABSOLUTE MAXIMUM RATINGS ($T_A = 25^\circ\text{C}$ UNLESS OTHERWISE NOTED)					
Parameter	Symbol	Single	Total Quad	Unit	
Drain-Source Voltage	V_{DS}	-60		V	
Gate-Source Voltage	V_{GS}	± 30			
Continuous Drain Current ($T_J = 150^\circ\text{C}$)	I_D	$T_A = 25^\circ\text{C}$	-0.41	A	
		$T_A = 100^\circ\text{C}$	-0.23		
Pulsed Drain Current ^a	I_{DM}	-3			
Power Dissipation	P_D	$T_A = 25^\circ\text{C}$	1.3	2	W
		$T_A = 100^\circ\text{C}$	0.52	0.8	
Thermal Resistance, Junction-to-Ambient	R_{thJA}	96	62.5	$^\circ\text{C/W}$	
Operating Junction and Storage Temperature Range	T_J, T_{stg}	-55 to 150		$^\circ\text{C}$	

Notes

a. Pulse width limited by maximum junction temperature.

SPECIFICATIONS ($T_A = 25^\circ\text{C}$ UNLESS OTHERWISE NOTED)						
Parameter	Symbol	Test Conditions	Limits			Unit
			Min	Typ ^a	Max	
Static						
Drain-Source Breakdown Voltage	$V_{(BR)DSS}$	$V_{GS} = 0\text{ V}, I_D = -10\ \mu\text{A}$	-60	-110		V
Gate-Threshold Voltage	$V_{GS(th)}$	$V_{DS} = V_{GS}, I_D = -1\ \text{mA}$	-2	-3.4	-4.5	
Gate-Body Leakage	I_{GSS}	$V_{DS} = 0\text{ V}, V_{GS} = \pm 30\text{ V}$ $T_J = 125^\circ\text{C}$			± 100	nA
					± 500	
Zero Gate Voltage Drain Current	I_{DSS}	$V_{DS} = -60\text{ V}, V_{GS} = 0\text{ V}$ $V_{DS} = -48\text{ V}, V_{GS} = 0\text{ V}, T_J = 125^\circ\text{C}$			-10	μA
					-500	
On-State Drain Current ^b	$I_{D(on)}$	$V_{DS} = -10\text{ V}, V_{GS} = -10\text{ V}$	-1	-2		A
Drain-Source On-Resistance ^b	$r_{DS(on)}$	$V_{GS} = -10\text{ V}, I_D = -1\text{ A}$ $T_J = 125^\circ\text{C}$		2.5	5	Ω
					4.4	
Forward Transconductance ^b	g_{fs}	$V_{DS} = -10\text{ V}, I_D = -0.5\text{ A}$	200	325		mS
Common Source Output Conductance ^b	g_{os}	$V_{DS} = -7.5\text{ V}, I_D = -0.1\text{ A}$		0.45		
Dynamic						
Input Capacitance	C_{iss}	$V_{DS} = -25\text{ V}, V_{GS} = 0\text{ V}$ $f = 1\text{ MHz}$		75	150	pF
Output Capacitance	C_{oss}			40	60	
Reverse Transfer Capacitance	C_{rss}			18	25	
Switching^c						
Turn-On Time	$t_{d(on)}$	$V_{DD} = -25\text{ V}, R_L = 47\ \Omega$ $I_D \cong -0.5\text{ A}, V_{GEN} = -10\text{ V}$ $R_G = 25\ \Omega$		11	15	ns
	t_r			30	40	
Turn-Off Time	$t_{d(off)}$			20	30	
	t_f			20	30	

Notes

- a. For DESIGN AID ONLY, not subject to production testing.
 b. Pulse test: $PW \leq 300\ \mu\text{s}$ duty cycle $\leq 2\%$.
 c. Switching time is essentially independent of operating temperature.

VPDV10

TYPICAL CHARACTERISTICS ($T_A = 25^\circ\text{C}$ UNLESS OTHERWISE NOTED)

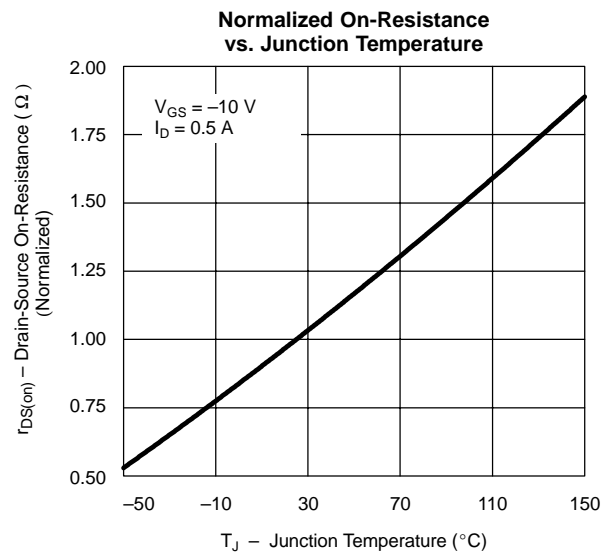
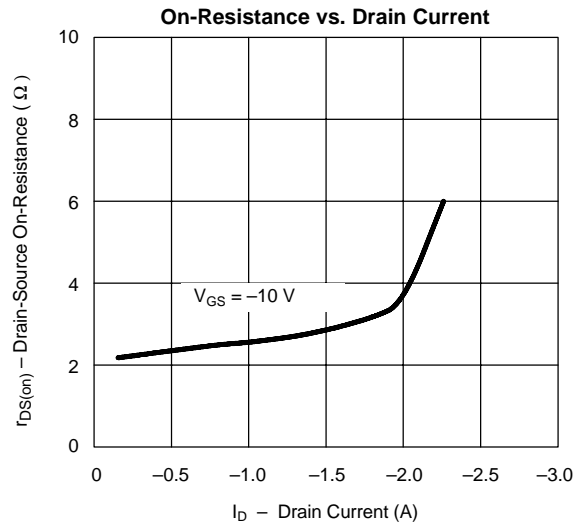
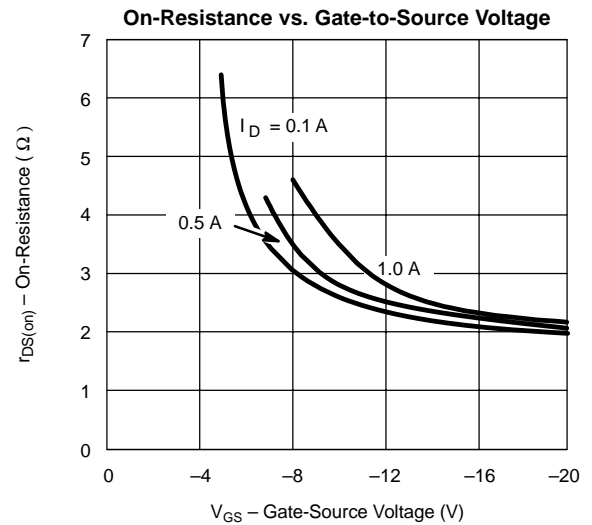
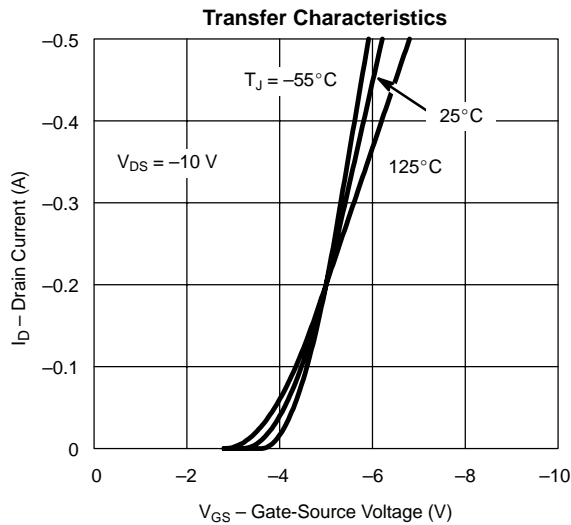
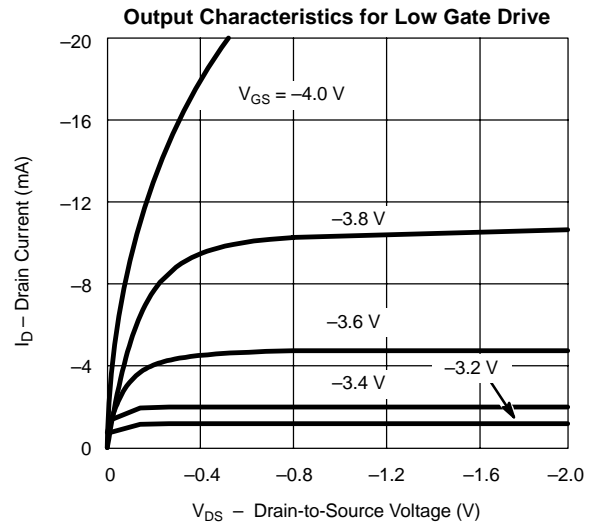
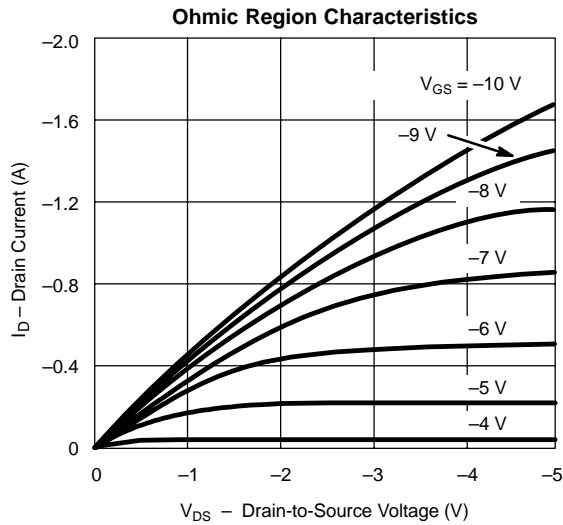

TYPICAL CHARACTERISTICS ($T_A = 25^\circ\text{C}$ UNLESS OTHERWISE NOTED)

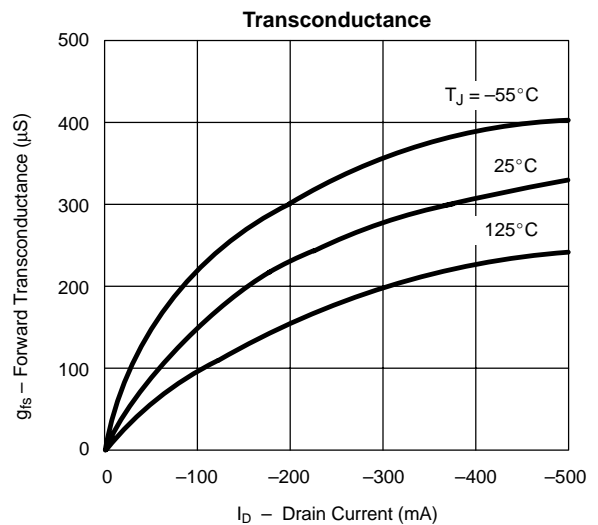
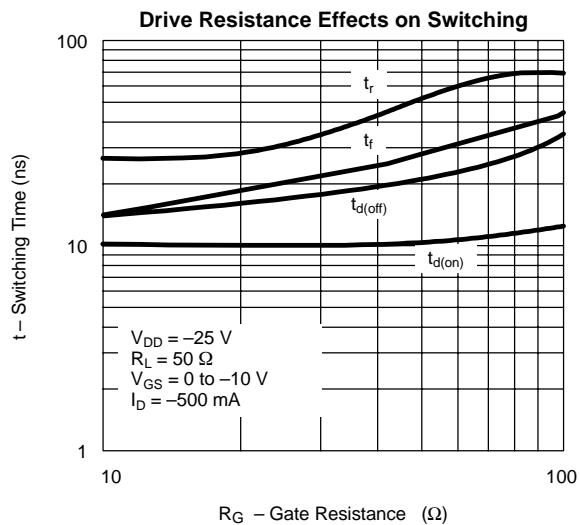
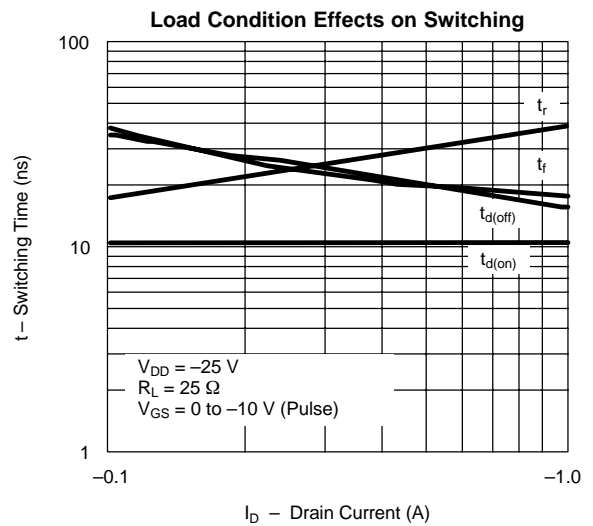
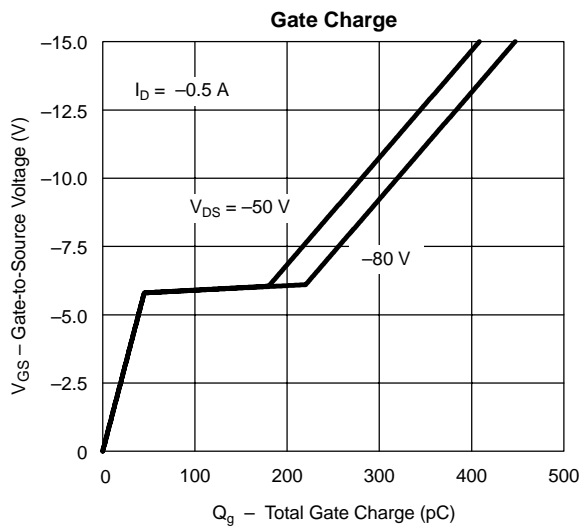
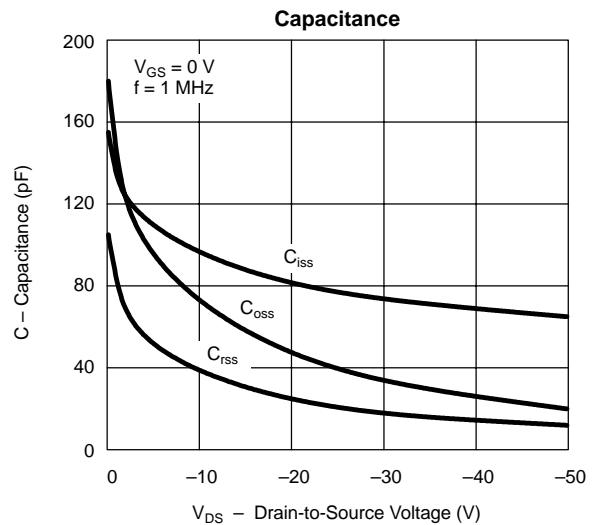
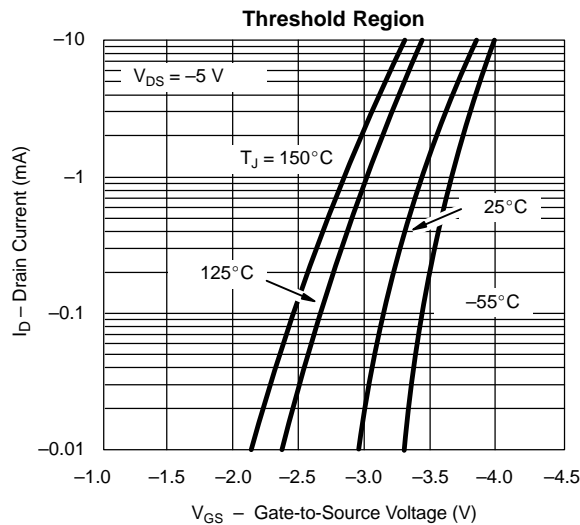



Disclaimer

All product specifications and data are subject to change without notice.

Vishay Intertechnology, Inc., its affiliates, agents, and employees, and all persons acting on its or their behalf (collectively, "Vishay"), disclaim any and all liability for any errors, inaccuracies or incompleteness contained herein or in any other disclosure relating to any product.

Vishay disclaims any and all liability arising out of the use or application of any product described herein or of any information provided herein to the maximum extent permitted by law. The product specifications do not expand or otherwise modify Vishay's terms and conditions of purchase, including but not limited to the warranty expressed therein, which apply to these products.

No license, express or implied, by estoppel or otherwise, to any intellectual property rights is granted by this document or by any conduct of Vishay.

The products shown herein are not designed for use in medical, life-saving, or life-sustaining applications unless otherwise expressly indicated. Customers using or selling Vishay products not expressly indicated for use in such applications do so entirely at their own risk and agree to fully indemnify Vishay for any damages arising or resulting from such use or sale. Please contact authorized Vishay personnel to obtain written terms and conditions regarding products designed for such applications.

Product names and markings noted herein may be trademarks of their respective owners.