

## BSS 295

### SIPMOS® Small-Signal Transistor

- N channel
- Enhancement mode
- Logic Level
- $V_{GS(th)} = 0.8...2.0V$

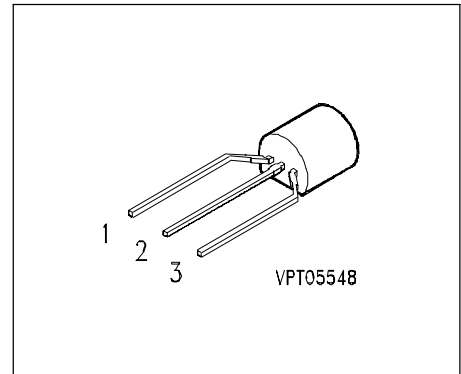

Pin 1	Pin 2	Pin 3
G	D	S

Type	$V_{DS}$	$I_D$	$R_{DS(on)}$	Package	Marking
BSS 295	50 V	1.4 A	0.3 $\Omega$	TO-92	SS 295

Type	Ordering Code	Tape and Reel Information
BSS 295	Q67000-S238	E6288
BSS 295	Q67000-S105	E6325

### Maximum Ratings

Parameter	Symbol	Values	Unit
Drain source voltage	$V_{DS}$	50	V
Drain-gate voltage	$V_{DGR}$	50	
$R_{GS} = 20 \text{ k}\Omega$			
Gate source voltage	$V_{GS}$	$\pm 20$	
ESD Sensitivity (HBM) as per MIL-STD 883		Class 1	
Continuous drain current	$I_D$	1.4	A
$T_A = 24 \text{ }^\circ\text{C}$			
DC drain current, pulsed	$I_{Dpuls}$	5.6	
$T_A = 25 \text{ }^\circ\text{C}$			
Power dissipation	$P_{tot}$	1	W
$T_A = 25 \text{ }^\circ\text{C}$			

**Maximum Ratings**

Parameter	Symbol	Values	Unit
Chip or operating temperature	$T_j$	-55 ... + 150	°C
Storage temperature	$T_{stg}$	-55 ... + 150	
Thermal resistance, chip to ambient air <sup>1)</sup>	$R_{thJA}$	≤ 125	K/W
DIN humidity category, DIN 40 040		E	
IEC climatic category, DIN IEC 68-1		55 / 150 / 56	

**Electrical Characteristics, at  $T_j = 25^\circ\text{C}$ , unless otherwise specified**

Parameter	Symbol	Values			Unit
		min.	typ.	max.	

**Static Characteristics**

Drain- source breakdown voltage $V_{GS} = 0\text{ V}, I_D = 0.25\text{ mA}, T_j = 25^\circ\text{C}$	$V_{(BR)DSS}$	50	-	-	V
Gate threshold voltage $V_{GS} = V_{DS}, I_D = 1\text{ mA}$	$V_{GS(th)}$	0.8	1.4	2	
Zero gate voltage drain current $V_{DS} = 50\text{ V}, V_{GS} = 0\text{ V}, T_j = 25^\circ\text{C}$	$I_{DSS}$	-	0.1	1	μA
$V_{DS} = 50\text{ V}, V_{GS} = 0\text{ V}, T_j = 125^\circ\text{C}$		-	8	50	
$V_{DS} = 30\text{ V}, V_{GS} = 0\text{ V}, T_j = 25^\circ\text{C}$		-	-	100	nA
Gate-source leakage current $V_{GS} = 20\text{ V}, V_{DS} = 0\text{ V}$	$I_{GSS}$	-	10	100	nA
Drain-Source on-state resistance $V_{GS} = 10\text{ V}, I_D = 1.4\text{ A}$	$R_{DS(on)}$	-	0.25	0.3	Ω
$V_{GS} = 4.5\text{ V}, I_D = 1.4\text{ A}$		-	0.45	0.5	

**Electrical Characteristics, at  $T_j = 25^\circ\text{C}$ , unless otherwise specified**

Parameter	Symbol	Values			Unit
		min.	typ.	max.	

**Dynamic Characteristics**

Transconductance $V_{DS} \geq 2 * I_D * R_{DS(on)max}, I_D = 1.4 \text{ A}$	$g_{fs}$	0.5	1.6	-	S
Input capacitance $V_{GS} = 0 \text{ V}, V_{DS} = 25 \text{ V}, f = 1 \text{ MHz}$	$C_{iss}$	-	320	425	pF
Output capacitance $V_{GS} = 0 \text{ V}, V_{DS} = 25 \text{ V}, f = 1 \text{ MHz}$	$C_{oss}$	-	110	170	
Reverse transfer capacitance $V_{GS} = 0 \text{ V}, V_{DS} = 25 \text{ V}, f = 1 \text{ MHz}$	$C_{rss}$	-	50	75	
Turn-on delay time $V_{DD} = 30 \text{ V}, V_{GS} = 10 \text{ V}, I_D = 0.29 \text{ A}$ $R_G = 50 \Omega$	$t_{d(on)}$	-	8	12	ns
Rise time $V_{DD} = 30 \text{ V}, V_{GS} = 10 \text{ V}, I_D = 0.29 \text{ A}$ $R_G = 50 \Omega$	$t_r$	-	20	30	
Turn-off delay time $V_{DD} = 30 \text{ V}, V_{GS} = 10 \text{ V}, I_D = 0.29 \text{ A}$ $R_G = 50 \Omega$	$t_{d(off)}$	-	120	160	
Fall time $V_{DD} = 30 \text{ V}, V_{GS} = 10 \text{ V}, I_D = 0.29 \text{ A}$ $R_G = 50 \Omega$	$t_f$	-	85	115	

**Electrical Characteristics**, at  $T_j = 25^\circ\text{C}$ , unless otherwise specified

Parameter	Symbol	Values			Unit
		min.	typ.	max.	
<b>Reverse Diode</b>					
Inverse diode continuous forward current $T_A = 25^\circ\text{C}$	$I_S$	-	-	1.4	A
Inverse diode direct current,pulsed $T_A = 25^\circ\text{C}$	$I_{SM}$	-	-	5.6	
Inverse diode forward voltage $V_{GS} = 0\text{ V}, I_F = 2.8\text{ A}$	$V_{SD}$	-	1	1.5	V

**Power dissipation**

$P_{tot} = f(T_A)$

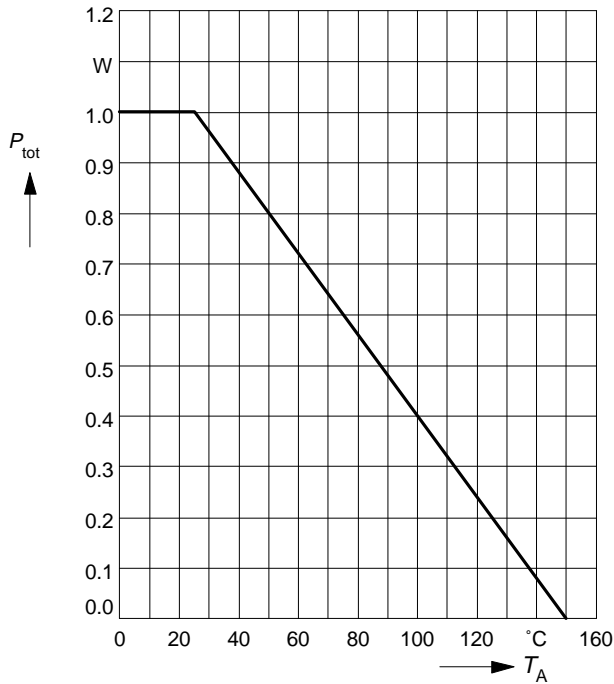

**Drain current**

$I_D = f(T_A)$

parameter:  $V_{GS} \geq 10$  V

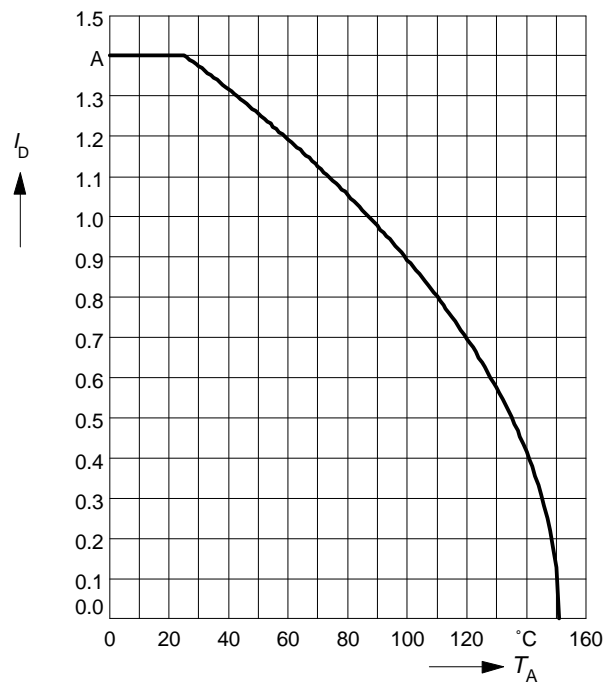

**Safe operating area  $I_D = f(V_{DS})$**

parameter :  $D = 0.01$ ,  $T_C = 25^\circ\text{C}$

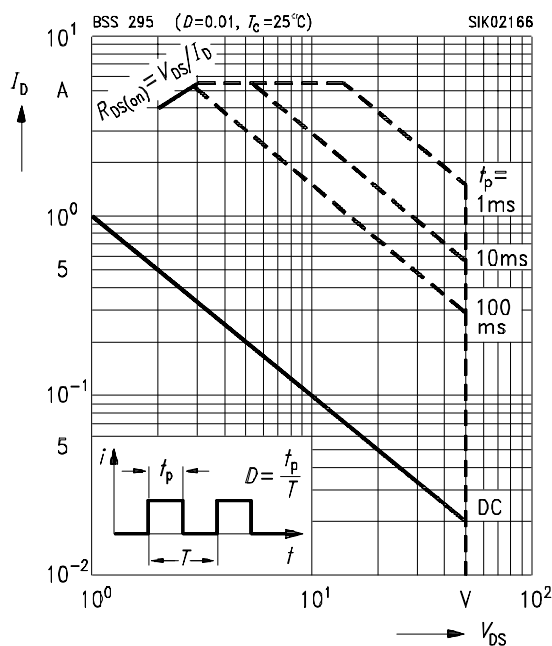

**Drain-source breakdown voltage**

$V_{(BR)DSS} = f(T_j)$

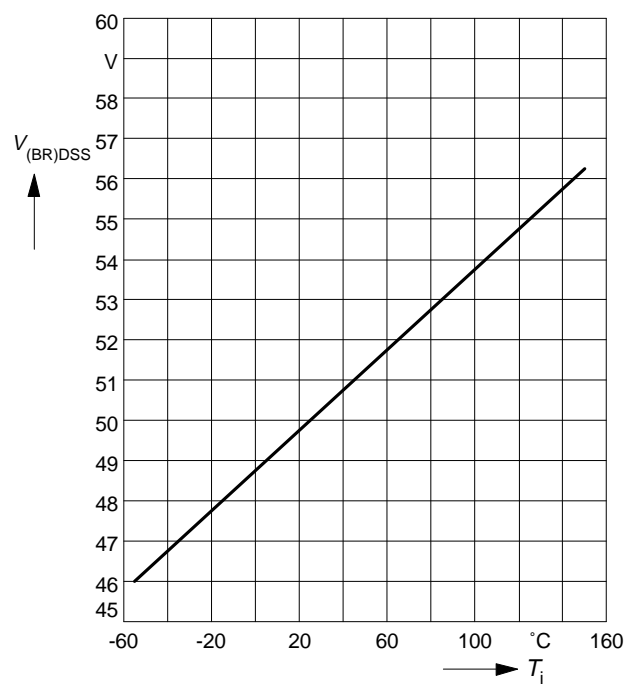

**Typ. output characteristics**

$I_D = f(V_{DS})$

parameter:  $t_p = 80 \mu s$ ,  $T_j = 25^\circ C$

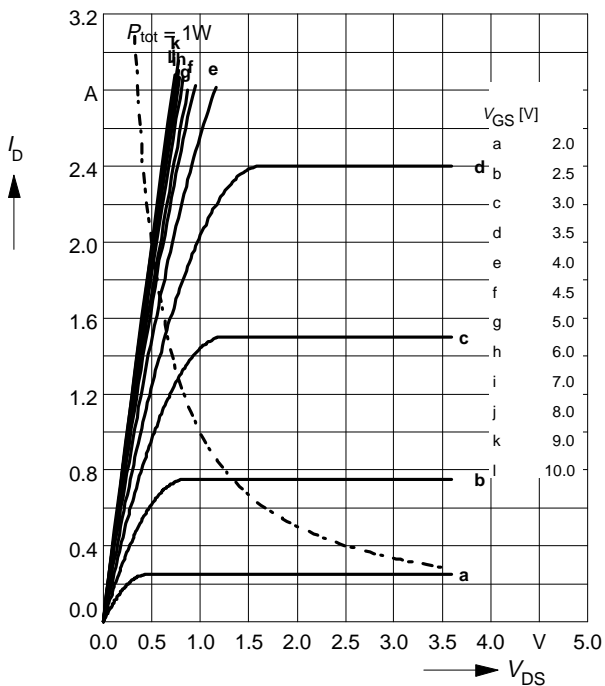

**Typ. drain-source on-resistance**

$R_{DS(on)} = f(I_D)$

parameter:  $t_p = 80 \mu s$ ,  $T_j = 25^\circ C$

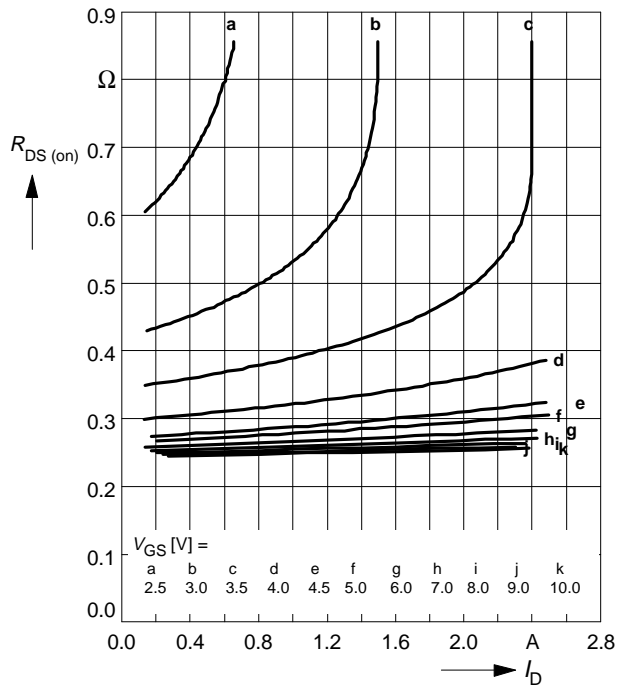

**Typ. transfer characteristics  $I_D = f(V_{GS})$**

parameter:  $t_p = 80 \mu s$

$V_{DS} \geq 2 \times I_D \times R_{DS(on)max}$

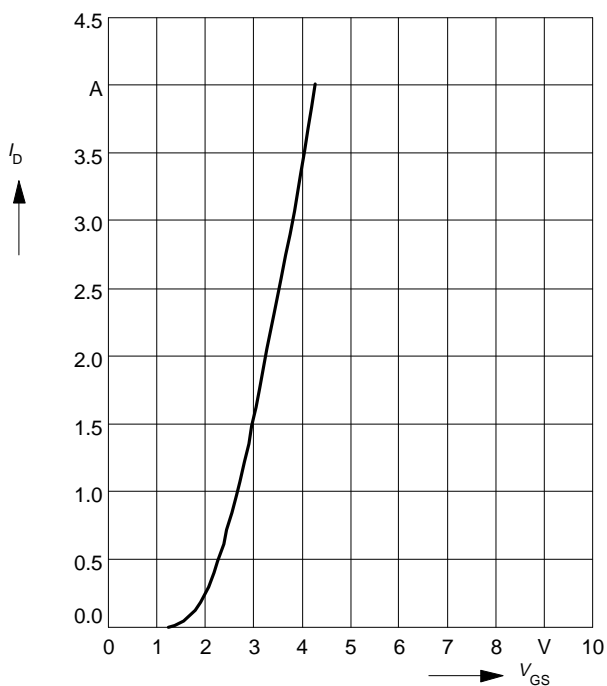

**Typ. forward transconductance  $g_{fs} = f(I_D)$**

parameter:  $t_p = 80 \mu s$ ,

$V_{DS} \geq 2 \times I_D \times R_{DS(on)max}$

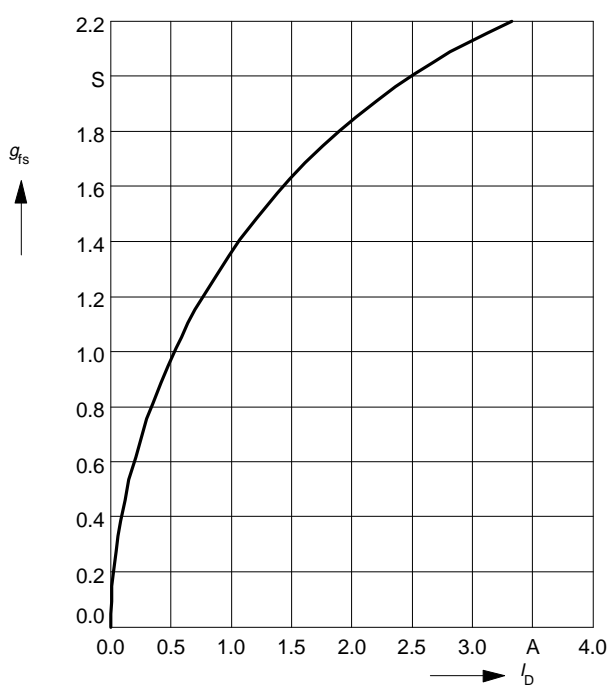

**Drain-source on-resistance**

$$R_{DS(on)} = f(T_j)$$

parameter:  $I_D = 1.4 \text{ A}$ ,  $V_{GS} = 10 \text{ V}$

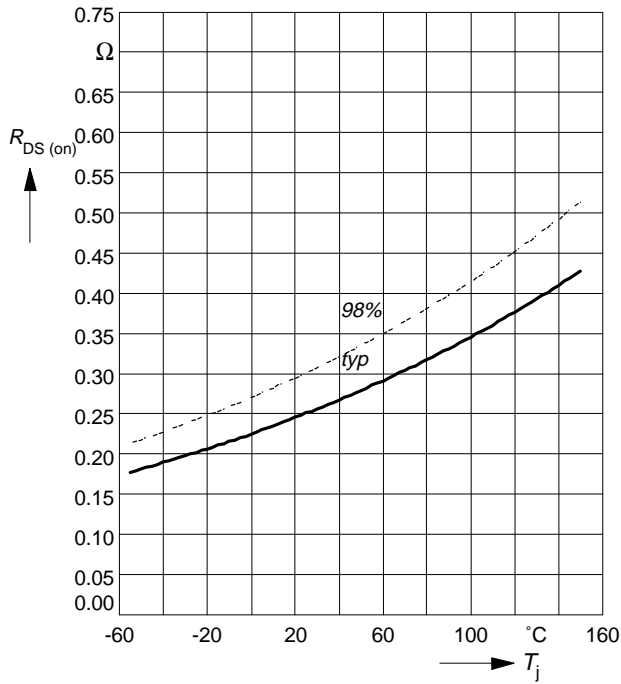

**Gate threshold voltage**

$$V_{GS(th)} = f(T_j)$$

parameter:  $V_{GS} = V_{DS}$ ,  $I_D = 1 \text{ mA}$

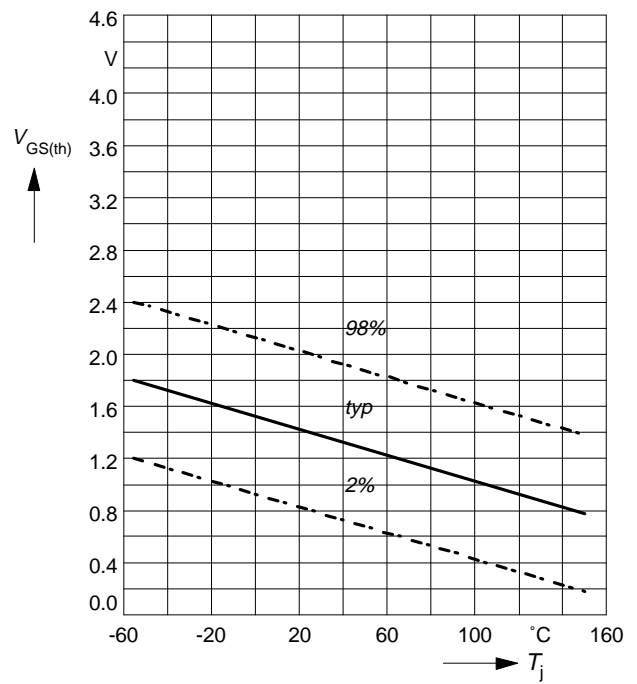

**Typ. capacitances**

$$C = f(V_{DS})$$

parameter:  $V_{GS} = 0 \text{ V}$ ,  $f = 1 \text{ MHz}$

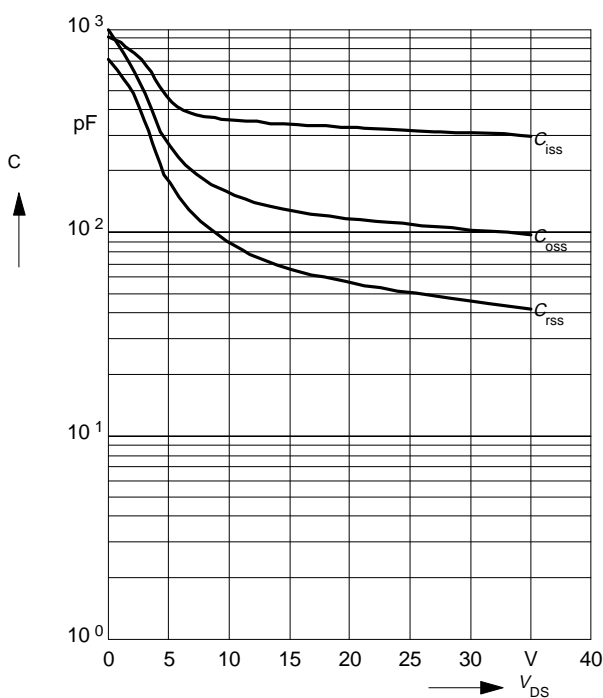

**Forward characteristics of reverse diode**

$$I_F = f(V_{SD})$$

parameter:  $T_j, t_p = 80 \mu\text{s}$

