

MSA-2643

Cascadable Silicon Bipolar Gain Block MMIC Amplifier



Data Sheet

Description

Avago Technologies' MSA-2643 is a low current silicon gain block MMIC amplifier housed in a 4-lead SC-70 (SOT-343) surface mount plastic package.

Providing a nominal 15.9 dB gain at up to 9.4 dBm Pout, this device is ideal for small-signal gain stages or IF amplification.

The Darlington feedback structure provides inherent broad bandwidth performance. The 25 GHz f_t fabrication process results in a device with low current draw and useful operation to past 3 GHz.

Surface Mount Package, SOT-343 / 4-lead SC70

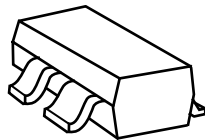

Pin Connections and Package Marking

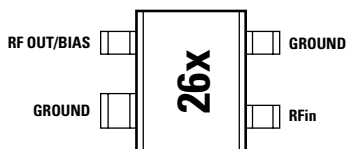

Note:

Top View. Package marking provides orientation and identification. 'x' is a character to identify date code.

Typical Biasing Configuration

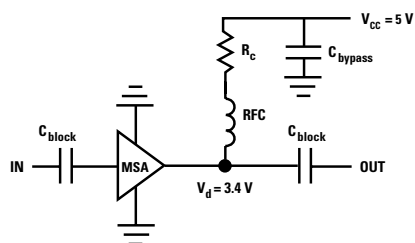

Features

- Small signal gain amplifier
- Low current draw
- Wide bandwidth
- 50 Ohms input & output
- Low cost surface mount small plastic package SOT-343 (4 lead SC-70)
- Tape-and-reel packaging option available

Specifications

2 GHz; 5V, 27 mA (typ.)

- 15.9 dB associated gain
- 9.4 dBm P1dB
- 3.6 dB noise figure
- 21.9 dBm output IP3
- Useful gain past 3 GHz

Applications

- Cellular/PCS/WLL basestations
- Wireless data / WLAN
- Fiber-optic systems
- ISM
- General purpose gain block amplifier

MSA-2643 Absolute Maximum Ratings^[1]

Symbol	Parameter	Units	Absolute Maximum
I_d	Device Current	mA	70
P_{diss}	Total Power Dissipation ^[2]	mW	230
$P_{in\ max}$	RF Input Power	dBm	18
T_{Jmax}	Junction Temperature	°C	150
T_{STG}	Storage Temperature	°C	-65 to 150
θ_{jc}	Thermal Resistance ^[3]	°C/W	128

Notes:

1. Operation of this device above any one of these parameters may cause permanent damage.
2. Ground lead temperature is 25°C. Derate 7.4 mW/°C for $T_L > 119^\circ\text{C}$.
3. Thermal resistance measured using 150°C Liquid Crystal Measurement method.

Electrical Specifications

$T_A = +25^\circ\text{C}$, $I_d = 27\ \text{mA}$, $Z_0 = 50\ \Omega$, RF parameters measured in a test circuit for a typical device

Symbol	Parameter and Test Condition	Frequency	Units	Min.	Typ. ^[1]	Max.	σ
V_d	Device Voltage, $I_d = 27\ \text{mA}$		V	3.0	3.4	3.8	0.03
G_p	Power Gain ($ S_{21} ^2$)	900 MHz 2 GHz	dB	14.5	16.9 15.9	17.5	0.2 0.2
ΔG_p	Gain Flatness	0.1 to 2 GHz	dB		± 0.56		
F_{3dB}	3 dB Bandwidth		GHz		4.2		
$VSWR_{in}$	Input Voltage Standing Wave Ratio	0.1 to 6 GHz			1.8:1		
$VSWR_{out}$	Output Voltage Standing Wave Ratio	0.1 to 6 GHz			1.5:1		
NF	50 Ω Noise Figure	900 MHz 2 GHz	dB		3.5 3.6		0.15 0.11
P_{1dB}	Output Power at 1 dB Gain Compression	900 MHz 2 GHz	dBm		10.6 9.4		0.07 0.07
OIP_3	Output Third Order Intercept Point	900 MHz 2 GHz	dBm		24.8 21.9		0.09 0.17
DV/dT	Device Voltage Temperature Coefficient		mV/°C		-4.4		

Notes:

1. Typical value determined from a sample size of 500 parts from 6 wafers.
2. Standard deviation is based on 500 samples taken from 6 different wafers. Future wafers allocated to this product may have typical values anywhere between the minimum and maximum specification limits.

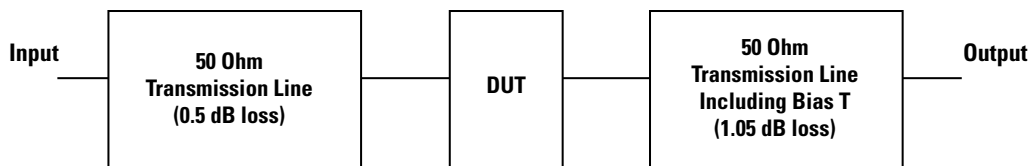

Block diagram of 2 GHz production test board used for gain measurements. Circuit losses have been de-embedded from actual measurements.

MSA-2643 Typical Performance

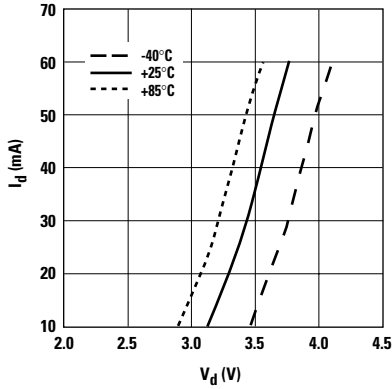

Figure 1. I_d vs. V_d and Temperature.

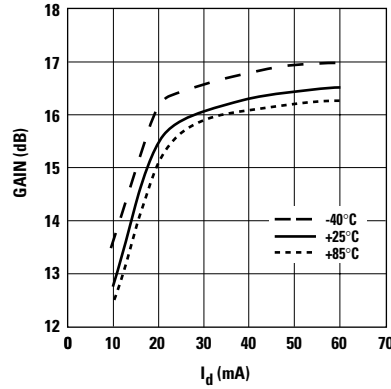

Figure 2. Gain vs. I_d and Temperature at 2 GHz.

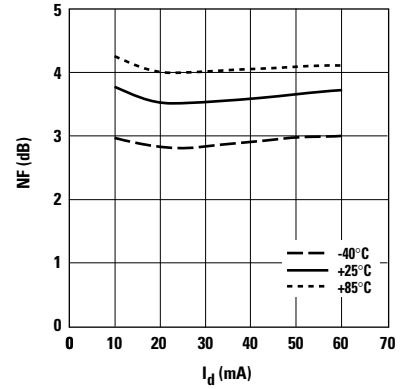

Figure 3. NF vs. I_d and Temperature at 2 GHz.

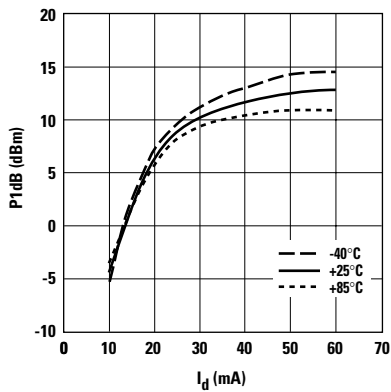

Figure 4. P1dB vs. I_d and Temperature at 2 GHz.

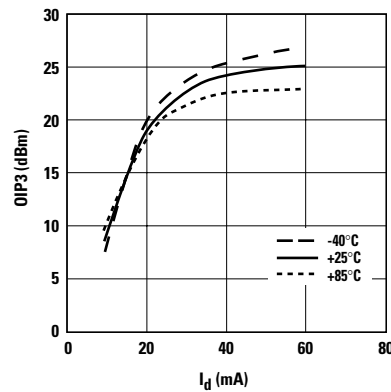

Figure 5. OIP3 vs. I_d and Temperature at 2 GHz.

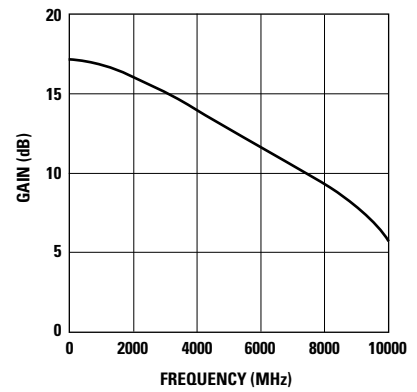

Figure 6. Gain vs. Frequency at $I_d = 27$ mA.

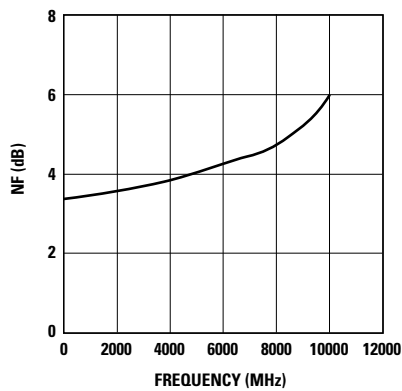

Figure 7. Noise Figure vs. Frequency at $I_d = 27$ mA.

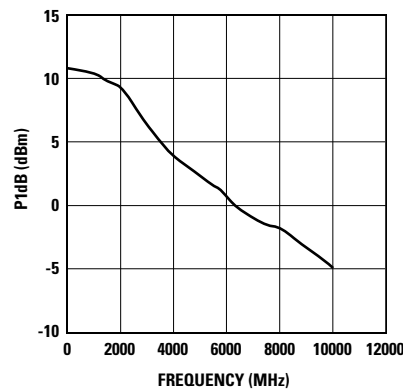

Figure 8. P1dB vs. Frequency at $I_d = 27$ mA.

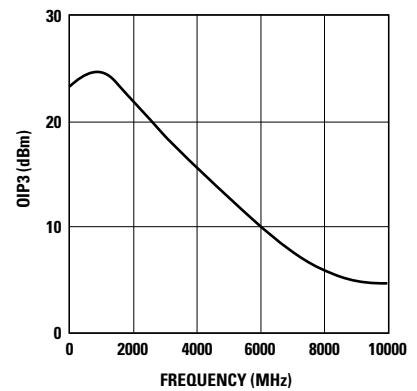

Figure 9. OIP3 vs. Frequency at $I_d = 27$ mA.

MSA-2643 Typical Performance, continued

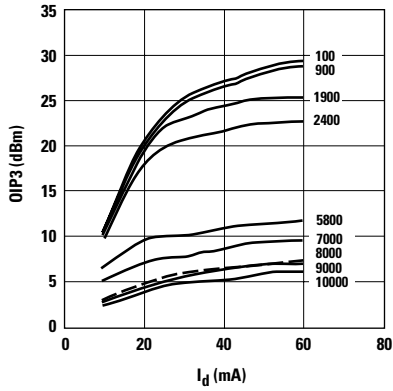

Figure 10. OIP3 vs. I_d and Frequency (MHz).

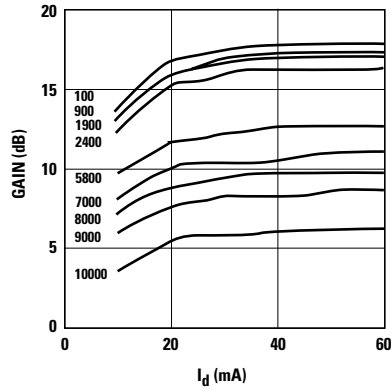

Figure 11. Gain vs. I_d and Frequency (MHz).

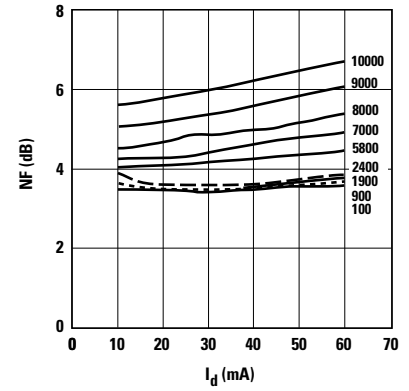

Figure 12. NF vs. I_d and Frequency (MHz).

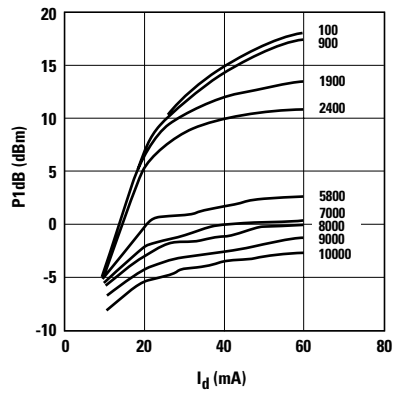

Figure 13. P1dB vs. I_d and Frequency (MHz).

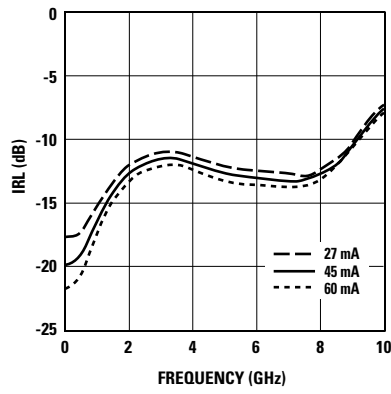

Figure 14. Input Return Loss vs. Frequency and I_d .

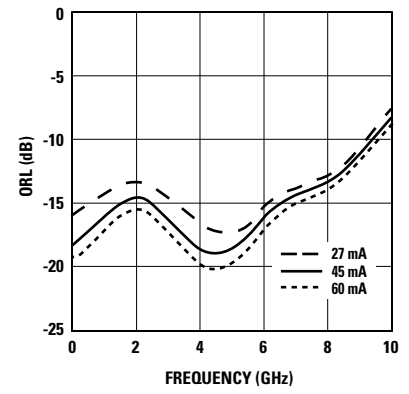

Figure 15. Output Return Loss vs. Frequency and I_d .

MSA-2643 Typical Scattering Parameters

$T_A = 25^\circ\text{C}$, $I_d = 27\text{ mA}$

Freq (GHz)	S_{11} Mag	S_{11} Ang	S_{21} (dB)	S_{21} (Mag)	S_{21} (Ang)	S_{12} (dB)	S_{12} (Mag)	S_{12} (Ang)	S_{22} (Mag)	S_{22} (Ang)	K
0.1	0.13	0	17.0	7.21	177	-20.7	0.093	-1	0.15	-4	1.1
0.5	0.14	8	17.0	7.21	163	-20.8	0.092	-4	0.17	-25	1.1
1.0	0.18	-1	16.8	7.04	146	-21.1	0.088	-7	0.19	-49	1.1
1.5	0.22	-12	16.4	6.79	130	-21.4	0.085	-8	0.21	-67	1.1
2.0	0.25	-25	15.9	6.49	114	-21.5	0.084	-8	0.21	-81	1.1
2.5	0.27	-38	15.5	6.18	99	-21.6	0.083	-8	0.21	267	1.2
3.0	0.28	-50	15.0	5.88	85	-21.6	0.084	-9	0.19	255	1.2
3.5	0.28	-63	14.6	5.59	71	-21.5	0.084	-9	0.17	241	1.2
4.0	0.27	-77	14.2	5.31	57	-21.3	0.086	-10	0.15	224	1.2
4.5	0.26	-93	13.7	5.06	43	-21.1	0.088	-11	0.14	205	1.2
5.0	0.25	-111	13.3	4.79	29	-20.8	0.091	-13	0.14	187	1.3
5.5	0.24	-131	12.8	4.52	16	-20.6	0.093	-14	0.15	174	1.3
6.0	0.24	-155	12.2	4.24	3	-20.3	0.097	-15	0.17	164	1.3
6.5	0.23	-175	11.7	4.01	-10	-19.8	0.102	-17	0.19	158	1.3
7.0	0.23	-198	11.2	3.77	-22	-19.3	0.108	-20	0.21	150	1.3
7.5	0.23	-222	10.6	3.53	-35	-18.8	0.115	-23	0.22	141	1.3
8.0	0.23	-246	10.0	3.28	-48	-18.5	0.119	-27	0.23	128	1.3
8.5	0.26	-269	9.4	3.06	-60	-18.0	0.127	-29	0.25	117	1.3
9.0	0.30	71	8.7	2.84	-72	-17.1	0.139	-32	0.29	106	1.2
9.5	0.37	54	8.1	2.64	-84	-16.3	0.153	-38	0.35	97	1.1
10.0	0.44	39	7.3	2.42	-97	-15.6	0.165	-45	0.43	88	1.0

Notes:

1. S-parameters are measured on a microstrip line made on 0.025 inch thick alumina carrier. The input reference plane is at the end of the input lead. The output reference plane is at the end of the output lead. The parameters include the effect of four plated through via holes connecting ground landing pads on top of the test carrier to the microstrip ground plane on the bottom side of the carrier. Two 0.020 inch diameter via holes are placed within 0.010 inch from each ground lead contact point, one via on each side of that point.

MSA-2643 Typical Scattering Parameters, $T_A = 25^\circ\text{C}$, $I_d = 45\text{ mA}$

Freq (GHz)	S_{11} (Mag)	S_{11} (Ang)	S_{21} (dB)	S_{21} (Mag)	S_{21} (Ang)	S_{12} (dB)	S_{12} (Mag)	S_{12} (Ang)	S_{22} (Mag)	S_{22} (Ang)	K
0.1	0.10	1	17.7	7.69	177	-21.0	0.089	-1	0.12	-4	1.1
0.5	0.11	16	17.7	7.67	163	-21.1	0.088	-4	0.13	-27	1.1
1.0	0.15	6	17.5	7.49	146	-21.4	0.085	-6	0.15	-54	1.1
1.5	0.19	-7	17.2	7.21	129	-21.6	0.083	-7	0.17	-72	1.1
2.0	0.22	-20	16.8	6.88	114	-21.8	0.082	-7	0.18	-85	1.1
2.5	0.25	-33	16.3	6.54	99	-21.8	0.081	-7	0.17	263	1.2
3.0	0.26	-46	15.8	6.20	84	-21.8	0.082	-8	0.16	250	1.2
3.5	0.26	-58	15.4	5.87	70	-21.7	0.083	-8	0.14	236	1.2
4.0	0.25	-73	14.9	5.57	56	-21.5	0.085	-9	0.12	218	1.2
4.5	0.24	-88	14.5	5.30	43	-21.3	0.087	-10	0.12	197	1.2
5.0	0.22	-107	14.0	5.01	29	-21.0	0.090	-11	0.12	179	1.2
5.5	0.22	-128	13.5	4.72	16	-20.7	0.092	-12	0.13	167	1.3
6.0	0.21	-153	12.9	4.43	3	-20.3	0.097	-13	0.16	159	1.3
6.5	0.21	-174	12.4	4.18	-10	-19.8	0.102	-15	0.18	154	1.3
7.0	0.21	-197	11.9	3.93	-23	-19.3	0.109	-18	0.19	147	1.2
7.5	0.21	-222	11.3	3.69	-35	-18.7	0.116	-22	0.20	138	1.2
8.0	0.22	-248	10.7	3.43	-48	-18.4	0.121	-25	0.22	125	1.3
8.5	0.24	90	10.1	3.20	-60	-17.8	0.129	-27	0.24	114	1.3
9.0	0.29	70	9.5	2.97	-72	-17.0	0.141	-31	0.28	104	1.2
9.5	0.36	53	8.8	2.76	-84	-16.2	0.156	-37	0.35	95	1.1
10.0	0.43	38	8.1	2.53	-97	-15.5	0.168	-44	0.42	86	1.0

Notes:

- S-parameters are measured on a microstrip line made on 0.025 inch thick alumina carrier. The input reference plane is at the end of the input lead. The output reference plane is at the end of the output lead. The parameters include the effect of four plated through via holes connecting ground landing pads on top of the test carrier to the microstrip ground plane on the bottom side of the carrier. Two 0.020 inch diameter via holes are placed within 0.010 inch from each ground lead contact point, one via on each side of that point.

MSA-2643 Typical Scattering Parameters, $T_A = 25^\circ\text{C}$, $I_d = 60\text{ mA}$

Freq (GHz)	S_{11} (Mag)	S_{11} (Ang)	S_{21} (dB)	S_{21} (Mag)	S_{21} (Ang)	S_{12} (dB)	S_{12} (Mag)	S_{12} (Ang)	S_{22} (Mag)	S_{22} (Ang)	K
0.1	0.08	2	17.9	7.86	177	-21.1	0.088	-1	0.11	-4	1.1
0.5	0.09	20	17.9	7.84	163	-21.2	0.087	-4	0.12	-28	1.1
1.0	0.14	9	17.7	7.65	146	-21.5	0.084	-6	0.14	-55	1.1
1.5	0.18	-4	17.3	7.36	129	-21.7	0.082	-6	0.16	-73	1.1
2.0	0.21	-18	16.9	7.02	113	-21.8	0.081	-7	0.16	-86	1.1
2.5	0.24	-31	16.5	6.67	98	-21.9	0.081	-7	0.16	262	1.2
3.0	0.25	-44	16.0	6.31	84	-21.8	0.081	-7	0.14	250	1.2
3.5	0.25	-57	15.5	5.97	70	-21.7	0.083	-8	0.12	236	1.2
4.0	0.25	-72	15.1	5.66	56	-21.5	0.085	-8	0.10	217	1.2
4.5	0.23	-88	14.6	5.37	42	-21.3	0.086	-9	0.10	195	1.2
5.0	0.22	-107	14.1	5.08	28	-21.0	0.089	-11	0.10	177	1.3
5.5	0.21	-128	13.6	4.78	15	-20.7	0.092	-12	0.12	165	1.3
6.0	0.21	-153	13.0	4.49	2	-20.4	0.096	-13	0.14	158	1.3
6.5	0.21	-175	12.5	4.23	-11	-19.9	0.101	-15	0.16	155	1.3
7.0	0.21	-199	12.0	3.97	-24	-19.3	0.108	-18	0.18	148	1.3
7.5	0.21	-224	11.4	3.72	-36	-18.8	0.115	-21	0.19	139	1.3
8.0	0.22	-250	10.8	3.45	-49	-18.4	0.120	-25	0.20	126	1.3
8.5	0.25	88	10.2	3.22	-61	-17.9	0.128	-27	0.23	116	1.3
9.0	0.30	68	9.5	2.99	-73	-17.1	0.140	-31	0.27	105	1.2
9.5	0.36	52	8.9	2.78	-85	-16.2	0.155	-36	0.34	96	1.1
10.0	0.44	36	8.1	2.54	-98	-15.5	0.167	-44	0.41	87	1.0

Notes:

- S-parameters are measured on a microstrip line made on 0.025 inch thick alumina carrier. The input reference plane is at the end of the input lead. The output reference plane is at the end of the output lead. The parameters include the effect of four plated through via holes connecting ground landing pads on top of the test carrier to the microstrip ground plane on the bottom side of the carrier. Two 0.020 inch diameter via holes are placed within 0.010 inch from each ground lead contact point, one via on each side of that point.

MSA-2643 ADS Model

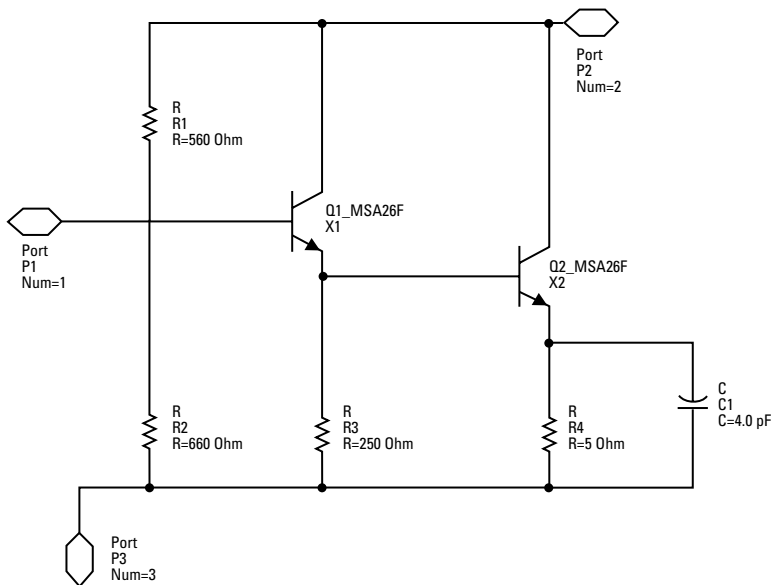
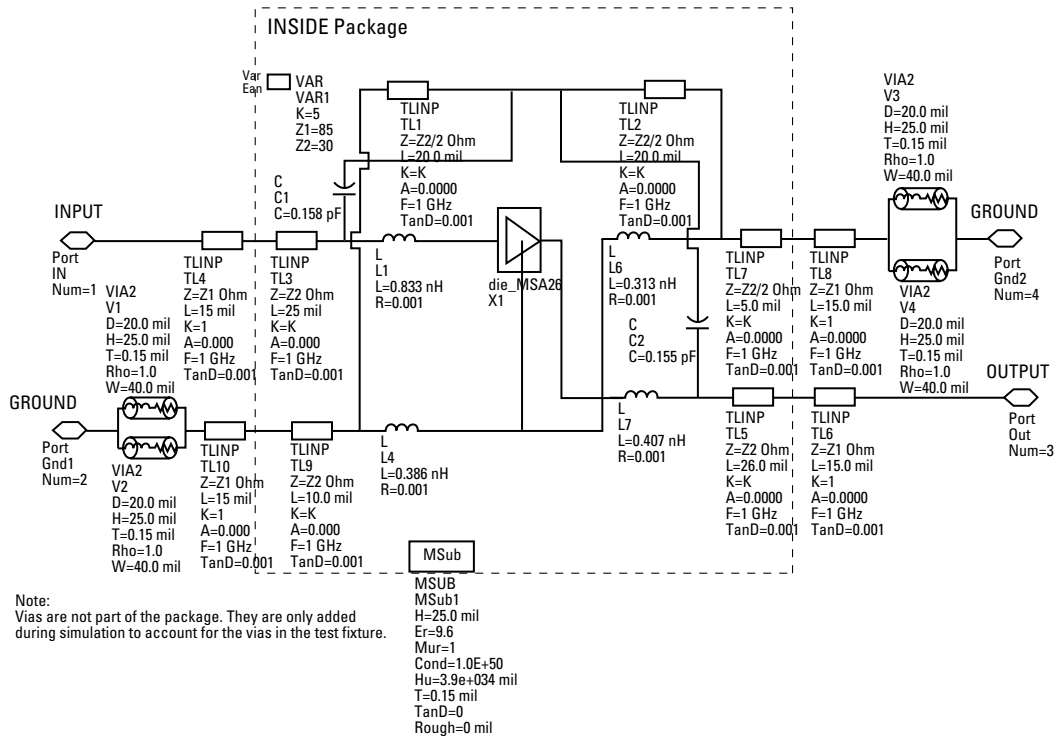

Q1 MSA-26 Transistor Model

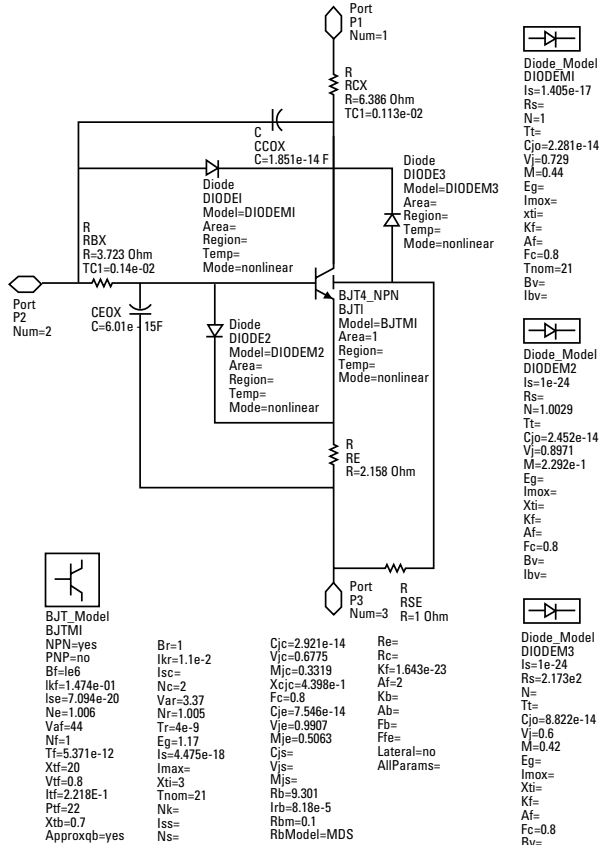

Diode_Model DIODEM1

Is=1.405e-17

Rs= N=1

Tt= Cjo=2.281e-14 Vj=0.729 M=0.44 Eg= Imox= xti= Kf= Af= Fc=0.8 Tnom=21 Bv= Ibv=

Isr= Nr= Ikf= Nbv= IbvL= NbvL= Tnom=21 Ffe= AllParams=



Diode_Model DIODEM2

Is=1e-24

Rs= N=1.0029

Tt= Cjo=2.452e-14 Vj=0.8971 M=2.292e-1 Eg= Imox= xti= Kf= Af= Fc=0.8 Bv= Ibv=

Isr= Nr= Ikf= Nbv= IbvL= NbvL= Tnom=21 Ffe= AllParams=



Diode_Model DIODEM3

Is=1e-24

Rs=2.173e2

N= Tt= Cjo=8.822e-14 Vj=0.6 M=0.42 Eg= Imox= xti= Kf= Af= Fc=0.8 Bv= Ibv=

Isr= Nr= Ikf= Nbv= IbvL= NbvL= Tnom=21 Ffe= AllParams=

Q2 MSA-26 Transistor Model

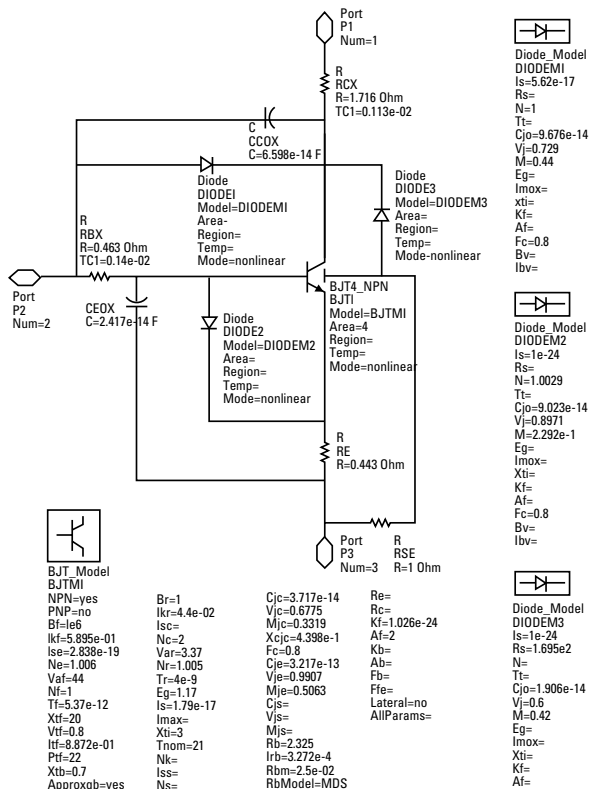

Diode_Model DIODEM1

Is=5.82e-17

Rs= N=1

Tt= Cjo=9.676e-14 Vj=0.729 M=0.44 Eg= Imox= xti= Kf= Af= Fc=0.8 Bv= Ibv=

Isr= Nr= Ikf= Nbv= IbvL= NbvL= Tnom=21 Ffe= AllParams=



Diode_Model DIODEM2

Is=1e-24

Rs= N=1.0029

Tt= Cjo=9.023e-14 Vj=0.8971 M=2.292e-1 Eg= Imox= xti= Kf= Af= Fc=0.8 Bv= Ibv=

Isr= Nr= Ikf= Nbv= IbvL= NbvL= Tnom=21 Ffe= AllParams=



Diode_Model DIODEM3

Is=1e-24

Rs=1.695e2

N= Tt= Cjo=1.906e-14 Vj=0.6 M=0.42 Eg= Imox= xti= Kf= Af= Fc=0.8 Bv= Ibv=

Isr= Nr= Ikf= Nbv= IbvL= NbvL= Tnom=21 Ffe= AllParams=

MSA-2643 RFIC Amplifier Description

Avago Technologies' MSA-2643 is a low current silicon gain block RFIC amplifier housed in a 4-lead SC-70 (SOT-343) surface mount plastic package. Providing a nominal 16.9 dB gain at up to +14.5 dBm Pout, this device is ideal for small-signal gain stages or IF amplification. The Darlington feedback structure provides inherent broad bandwidth performance. The 25 GHz f_t fabrication process results in a device with low current draw and useful operation above 3 GHz.

A feature of the MSA-2643 is its broad bandwidth that is useful in many satellite-based TV, cable TV and datacom systems.

In addition to use in buffer and driver amplifier applications in the TV market, the MSA-2643 will find many applications in wireless communication systems.

Application Guidelines

The MSA-2643 is very easy to use. For most applications, all that is required to operate the MSA-2643 is to apply 27 mA to 45 mA to the RF Output pin.

RF Input and Output

The RF Input and Output ports of the MSA-25643 are closely matched to 50Ω.

DC Bias

The MSA-2643 is a current-biased device that operates from a 27 mA to 45 mA current source. Curves of typical performance as a function of bias current are shown in section one of the data sheet. Figure 1 shows a typical implementation of the MSA-2643. The supply current for the MSA-2643 must be applied to the RF Output pin. The power supply connection

to the RF Output pin is achieved by means of a RF choke (inductor). The value of the RF choke must be large relative to 50Ω in order to prevent loading of the RF Output. The supply voltage end of R_c is bypassed to ground with a capacitor. Blocking capacitors are normally placed in series with the RF Input and the RF Output to isolate the DC voltages on these pins from circuits adjacent to the amplifier. The values for the blocking and bypass capacitors are selected to provide a reactance at the lowest frequency of operation that is small relative to 50Ω.

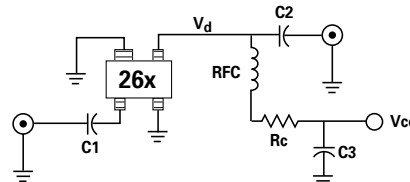

Figure 1. Schematic Diagram with Bias Connections.

PCB Layout

A recommended PCB pad layout for the miniature SOT-343 (SC-70) package that is used by the MSA-2643 is shown in Figure 2.

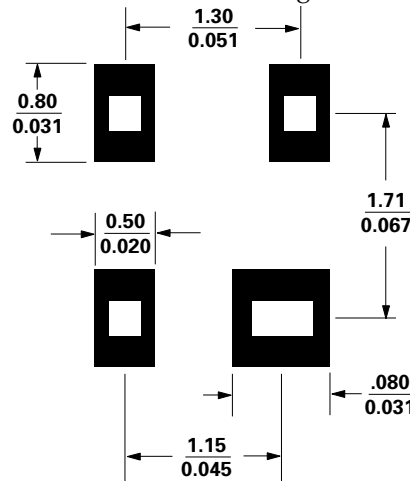

Figure 2. PCB Pad Layout for MSA-2643. Package dimensions in mm/inches.

This layout provides ample allowance for package placement by automated assembly equipment without adding parasitics that could impair the high frequency RF performance of the MSA-

2643. The layout is shown with a footprint of a SOT-343 package superimposed on the PCB pads for reference.

Starting with the package pad layout in Figure 3, an RF layout similar to the one shown in Figure 3 is a good starting point for microstripline designs using the MSA-2643 amplifier.

PCB Materials

FR-4 or G-10 type materials are good choices for most low cost wireless applications using single or multi-layer printed circuit boards. Typical single-layer board thickness is 0.020 to 0.031 inches. Circuit boards thicker than 0.031 inches are not recommended due to excessive inductance in the ground vias. This is discussed in more detail in the section on RF grounding.

Applications Example

The printed circuit layout in Figure 3 is a multi-purpose layout that will accommodate components for using the MSA-2643 for RF inputs from DC through 3 GHz. This layout is a microstripline design (solid groundplane on the backside of the circuit board) with 50Ω interfaces for the RF input and output. The circuit is fabricated on 0.031-inch thick FR-4 dielectric material. Plated through holes (vias) are used to bring the ground to the top side of the circuit where needed. Multiple vias are used to reduce the inductance of the paths to ground.

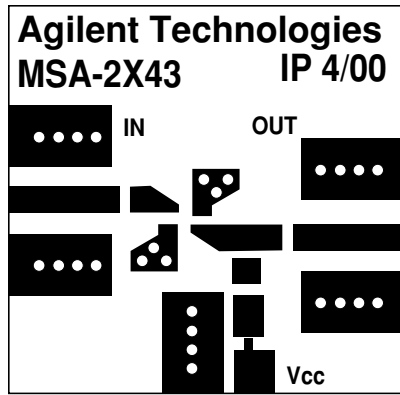

Figure 3. Multi-purpose Evaluation Board.

The amplifier and related components are assembled onto the printed circuit board as shown in Figure 6. The MSA-2X43 circuit board is designed to use edge-mounting SMA connectors such as Johnson Components, Inc., Model 142-0701-881. These connectors are designed to slip over the edge of 0.031-inch thick circuit boards and obviate the need to mount PCBs on a metal base plate for testing. The center conductors of the connectors are soldered to the input and output microstrip lines. The ground pins are soldered to the ground plane on the back of the board and to the top ground pads.

DC blocking capacitors are required at the input and output of the IC. The values of the blocking capacitors are determined by the lowest frequency of operation for a particular application. The capacitor's reactance is chosen to be 10% or less of the amplifier's input or output impedance at the lowest operating frequency. For example, an amplifier to be used in an application covering the 900 MHz band would require an input blocking capacitor of at least 39 pF, which is 4.5Ω of reactance at 900 MHz. The Vcc connection to the amplifier must be RF bypassed by placing a capacitor to ground at the bias pad of the board. Like the DC blocking capacitors, the value of the Vcc bypass capacitor is

determined by the lowest operating frequency for the amplifier. Space is available on the circuit board to add a bias choke, bypass capacitors, and collector resistors. The MSA series of ICs requires a bias resistor to ensure thermal stability. The bias resistor value is calculated from the operating current value, device voltage and the supply voltage; see equation below. When applying bias to the board, start at a low voltage level and slowly increase the voltage until the recommended current is reached. Both power and gain can be adjusted by varying I_d .

$$R_c = \frac{V_{cc} - V_d}{I_d} \Omega$$

Where:

- Vcc = The power supply voltage applied to Rc (volts)
- V_d = The device voltage (volts)
- I_d = The quiescent bias current drawn by the device

Notes on Rc Selection

The value of Rc is dependant on V_d , any production variation in V_d will have an effect on I_d . As the gain and power performance of the MSA-2643 may be adjusted by varying I_d this will have to be taken into account. The char-

acterization data in section one shows the relationship between V_d and I_d over temperature. At lower temperatures the value of V_d increases. The increase in V_d at low temperatures and production variations may cause potential problems for the amplifier performance if it is not taken into account. One solution would be to increase the voltage supply to have at least a 4V drop across the bias resistor Rc. This will guarantee good temperature stability over temperature. Table 1 shows the effects of Rc on the performance of the MSA-2643 over temperature.

An alternative solution to ensure good temperature stability without having a large voltage drop across a resistor would be to use an active bias circuit as shown in Figure 4. The resistors R1 and the PNP transistor connected to form a diode by connecting the base and collector together and R2 form a potential divider circuit to set the base voltage of the bias PNP transistor. The diode connected PNP transistor is used to compensate for the voltage variation with temperature of the bias PNP transistor. R3 provides a bleed path for any excess bias; it is a safety feature and can be omitted

Table 1. Effects of Rc on Performance over Temperature. Operating voltage = 3.4V nominally.

Voltage Drop, volts	Resistor Value, Ohms	Temperature, °C	Bias Current, mA	Power Gain @ 2.0 GHz, dB
0	0	0	16.7	14.8
		25	27.0	15.4
		85	40.7	15.3
1.5	56	0	25.4	15.6
		25	27.0	15.4
		85	30.5	15.0
4.0	150	0	26.2	15.6
		25	27.0	15.4
		85	28.5	15.1
6.5	240	0	26.5	15.6
		25	27.0	15.4
		85	28.0	15.1

from the circuit, a typical value for R3 is 1K Ω . R_c is a feedback element that keeps I_d constant. The value of R_c is approximated by assuming a 0.5V drop across it; see equation below. For 27 mA I_d, 5Volt V_{cc} bias, a typical value for R1 is 680 Ω and R2 is 180 Ω . A CAD program such as Avago Technologies ADS[®] is recommended to determine the values of R1 and R2 at other bias levels. The value of the RF choke should be large compared to 50 Ω , typical value for a 1.9 GHz amplifier would be 22 nH. The DC blocking capacitors are calculated as described above. A typical value for C3 would be 1.0 uF.

$$R_c = \frac{0.5}{I_d} \Omega$$

The active bias solution will only require about a 1.3V difference between V_{cc} and V_d for good bias stability over temperature. For more details on the active bias circuit please refer to application note AN-A003 Biasing MODAMP MMICs.

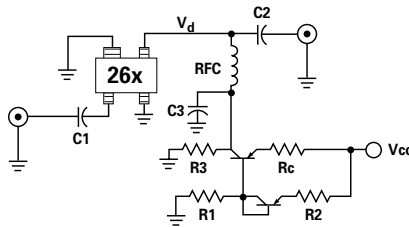

Figure 4. Active Bias Circuit.

1.9 GHz Design

To illustrate the simplicity of using the MSA-2643, a 1.9 GHz amplifier for PCS type applications is presented. The amplifier uses a 5V, 27 mA supply. The input and output of the MSA-2643 is already well matched to 50 Ω and no additional matching is needed.

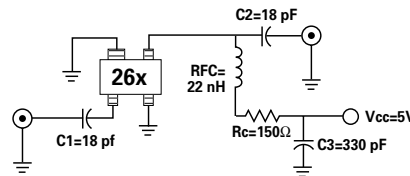

Figure 5. Schematic of 1.9 GHz Circuit.

A schematic diagram of the complete 1.9 GHz circuit with DC biasing is shown in Figure 5. DC bias is applied to the MSA-2643 through the RFC at the RF Output pin. The power supply connection is bypassed to ground with capacitor C3. Provision is made for an additional bypass capacitor, C4, to be added to the bias line near the +5 volt connection. C4 will not normally be needed unless several stages are cascaded using a common power supply.

The input terminal of the MSA-2643 is not at ground potential, an input DC blocking capacitor is needed.

The values of the DC blocking and RF bypass capacitors should be chosen to provide a small reactance (typically < 5 ohms) at the lowest operating frequency. For this 1.9 GHz design example, 18 pF capacitors with a reactance of 4.5 ohms are adequate. The reactance of the RF choke (RFC) should be high (i.e., several hundred ohms) at the lowest frequency of operation. A 22 nH inductor with a reactance of 262 ohms at 1.9 GHz is sufficiently high to minimize the loss from circuit loading.

Table 2. Component Parts List for the MSA-2643 Amplifier at 1.9 GHz.

R1	56 Ω chip resistor
RFC	22 nH LL1608-FH22N
C1,C2	18 pF chip capacitor
C3	330 pF chip capacitor

The completed 1.9 GHz amplifier for this example with all components and SMA connectors assembled is shown in Figure 6.

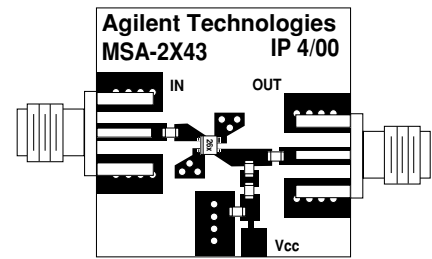

Figure 6. Complete 1.9 GHz Amplifier.

Performance of MSA-2643 1.9 GHz Amplifier

The amplifier is biased at a V_{cc} of 5 volts, I_d of 27 mA. The measured gain, noise figure, input and output return loss of the completed amplifier is shown in Figure 7. Noise figure is a nominal 3.8 to 4.0 dB from 1800 through 2000 MHz. Gain is a minimum of 15.4 dB from 1800 MHz through 2000 MHz. The amplifier output intercept point (OIP3) was measured at a nominal +20.7 dBm. P_{-1dB} measured +8.8 dBm.

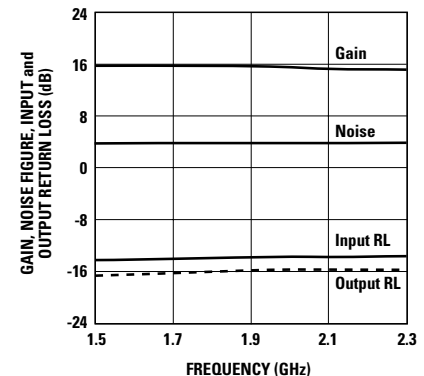

Figure 7. Gain, Noise Figure, Input and Output Return Loss Results.

900 MHz Design

The 900 MHz example follows the same design approach that was described in the previous 1900 MHz design. A schematic diagram of the complete 900 MHz circuit is shown in Figure 8. And the component part list is shown in Table 3.

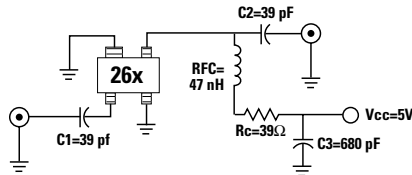

Figure 8. Schematic of 900 MHz Circuit.

Table 3. Component Parts List for the MSA-2643 Amplifier at 900 MHz.

R1	39Ω chip resistor
RFC	47 nH LL1608-FH47N
C1,C2	39 pF chip capacitor
C3	680 pF chip capacitor

Performance of MSA-2643 900 MHz Amplifier

The amplifier is biased at a V_{cc} of 5 volts, I_d of 40 mA. The measured gain, noise figure, input and output return loss of the completed amplifier is shown in Figure 9. Noise figure is a nominal 3.8 to 4.0 dB from 800 through 1000 MHz. Gain is a minimum of 17.1 dB from 800 MHz through 1000 MHz. The input return loss at 900 MHz is 15.2 dB with a corresponding output return loss of 16.9 dB. The amplifier output intercept point (OIP3) was measured at a nominal +28.2 dBm. P_{-1dB} measured +14.6 dBm.

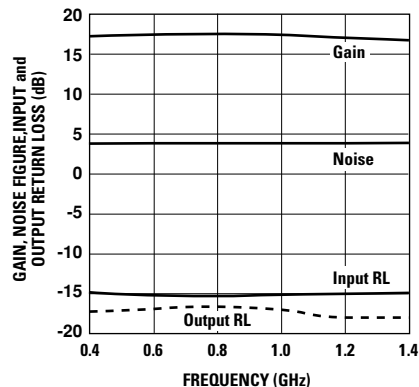

Figure 9. Gain, Noise Figure, Input and Output Return Loss Results.

Designs for Other Frequencies

The same basic design approach described above for 1.9 GHz can be applied to other frequency bands. Inductor values for matching the input for low noise figure are shown in Table 4.

Table 4. Input and Output Inductor Values for Various Operating Frequencies.

Frequency	C1 & C2, pF	RFC, nH	C3, pF
400 MHz	88	100	1500
900 MHz	39	47	680
1900 MHz	18	22	330
2.4 GHz	15	18	270
3.5 GHz	18	15	22
5.8 GHz	1.8	6.8	10

Actual component values may differ slightly from those shown in Table 3 due to variations in circuit layout, grounding, and component parasitics. A CAD program such as Avago Technologies' ADS® is recommended to fully analyze and account for these circuit variables.

Notes on RF Grounding

The performance of the MSA series is sensitive to ground path inductance. Good grounding is critical when using the MSA-2643. The use of via holes or equivalent minimal path ground returns as close to the package edge as is practical is recommended to assure good RF grounding. Multiple vias are used on the evaluation board to reduce the inductance of the path to ground. The effects of the poor grounding may be observed as a "peaking" in the gain versus frequency response, an increase in input VSWR, or even as return gain at the input of the RFIC.

A Final Note on Performance

Actual performance of the MSA RFIC mounted on the demonstration board may not exactly match data sheet specifications. The board material, passive components, and connectors all introduce losses and parasitics that may degrade device performance, especially at higher frequencies. Some variation in measured results is also to be expected as a result of the normal manufacturing distribution of products.

Statistical Parameters

Several categories of parameters appear within this data sheet. Parameters may be described with values that are either "minimum or maximum," "typical," or "standard deviations."

The values for parameters are based on comprehensive product characterization data, in which automated measurements are made on of a minimum of 500 parts taken from six non-consecutive process lots of semiconductor wafers. The data derived from product characterization tends to be normally distributed, e.g., fits the standard bell curve.

Parameters considered to be the most important to system performance are bounded by *minimum* or *maximum* values. For the MSA-2643, these parameters are: Gain (G_{test}) and Device Voltage (V_d). Each of the guaranteed parameters is 100% tested as part of the manufacturing process.

Values for most of the parameters in the table of Electrical Specifications that are described by *typical* data are the mathematical mean (μ), of the normal distribution taken from the characterization data. For parameters where measurements or mathematical averaging may not be practical, such as S-parameters or Noise Parameters and the performance curves, the data represents a nominal part taken from the center of the characterization distribution. Typical values are intended to be used as a basis for electrical design.

To assist designers in optimizing not only the immediate amplifier circuit using the MSA-2643, but to also evaluate and optimize trade-offs that affect a complete wireless system, the *standard deviation* (σ) is provided for many of the Electrical Specifications parameters (at 25°C) in addition to the mean. The standard deviation is a measure of the variability about the mean. It will be recalled that a normal distribution is completely described by the mean and standard deviation.

Standard statistics tables or calculations provide the probability of a parameter falling between any two values, usually symmetrically located about the mean. Referring to Figure 10 for example, the probability of a parameter being between $\pm 1\sigma$ is 68.3%; between $\pm 2\sigma$ is 95.4%; and between $\pm 3\sigma$ is 99.7%.

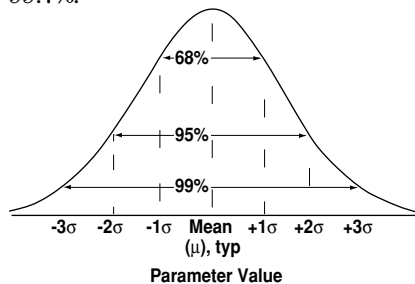

Figure 10. Normal Distribution.

Phase Reference Planes

The positions of the reference planes used to specify S-parameters for the MSA-2643 are shown in Figure 11. As seen in the illustration, the reference planes are located at the point where the package leads contact the test circuit for the RF input and RF output/bias. As noted under the s-parameter table in section one of the data sheet the MSA-2643 was tested in a fixture that includes plated through holes through a 0.025" thickness printed circuit board. Due to the complexity of de-embedding these grounds, the S-parameters include the effects of the test fixture grounds. Therefore, when simulating the performance of the MSA-2643 the added ground path inductance should be taken into account. For example if you were designing an amplifier on 0.031" thickness printed circuit board material, only the difference in the printed circuit board thickness needs to be included in the simulation, i.e. $0.031" - 0.025" = 0.006"$.

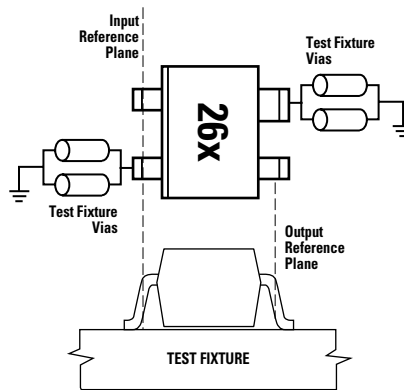

Figure 11. Phase Reference Planes.

References

Performance data for MSA series of amplifiers are found in the CD ROM Catalog or <http://www.Avagotech.com/view/rf>

Application Notes

- AN-S001: Basic MODAMP MMIC Circuit Techniques
- AN-S002: MODAMP MMIC Nomenclature
- AN-S003: Biasing MODAMP MMICs
- AN-S011: Using Silicon MMIC Gain Blocks as Transimpedance Amplifiers
- AN-S012: MagIC Low Noise Amplifiers

Ordering Information

Part Number	No. of Devices	Container
MSA-2643-TR1	3000	7" Reel
MSA-2643-TR2	10000	13" Reel
MSA-2643-BLK	100	antistatic bag

Package Dimensions Outline 43 SOT-343 (SC70 4-lead)

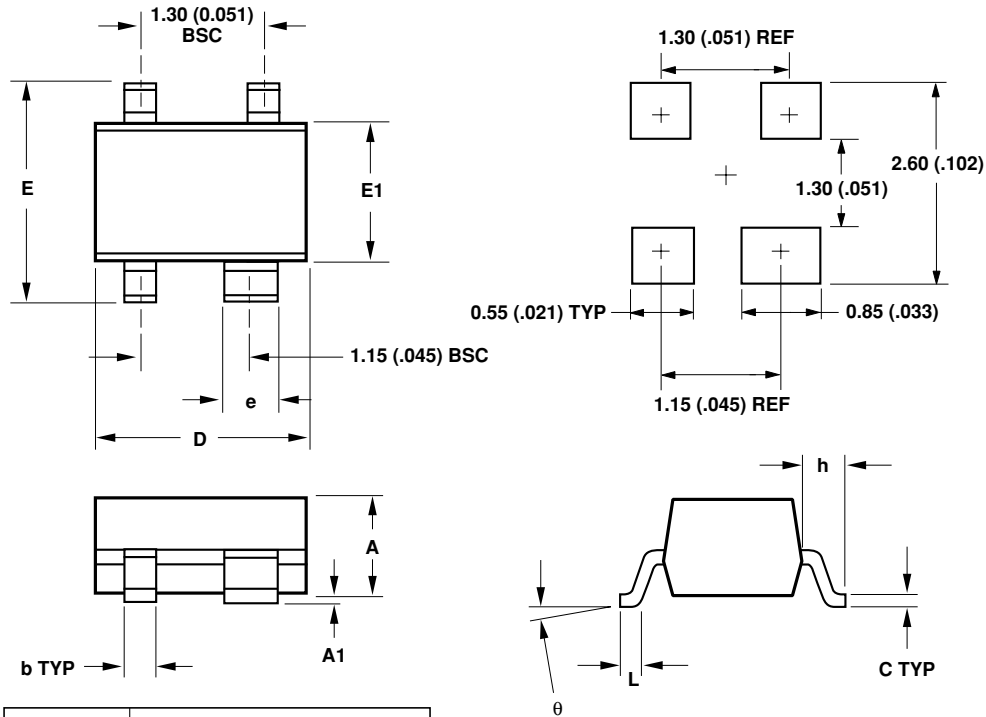

SYMBOL	DIMENSIONS	
	MIN.	MAX.
A	0.80 (0.031)	1.00 (0.039)
A1	0 (0)	0.10 (0.004)
b	0.25 (0.010)	0.35 (0.014)
C	0.10 (0.004)	0.20 (0.008)
D	1.90 (0.075)	2.10 (0.083)
E	2.00 (0.079)	2.20 (0.087)
e	0.55 (0.022)	0.65 (0.025)
h	0.450 TYP (0.018)	
E1	1.15 (0.045)	1.35 (0.053)
L	0.10 (0.004)	0.35 (0.014)
θ	0	10

DIMENSIONS ARE IN MILLIMETERS (INCHES)

Device Orientation

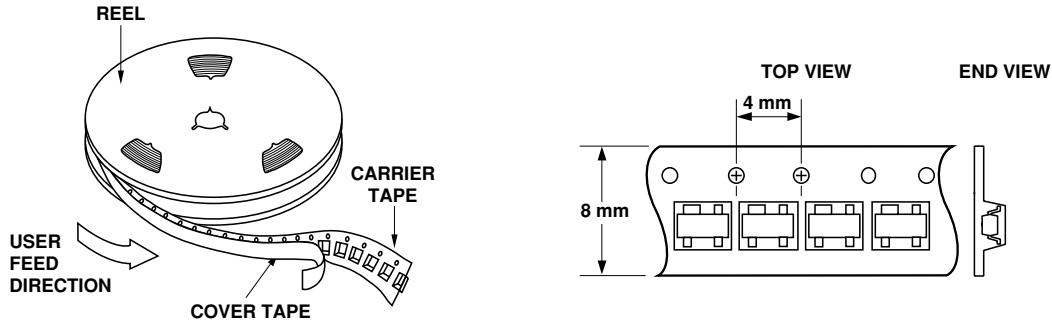

Tape Dimensions For Outline 4T

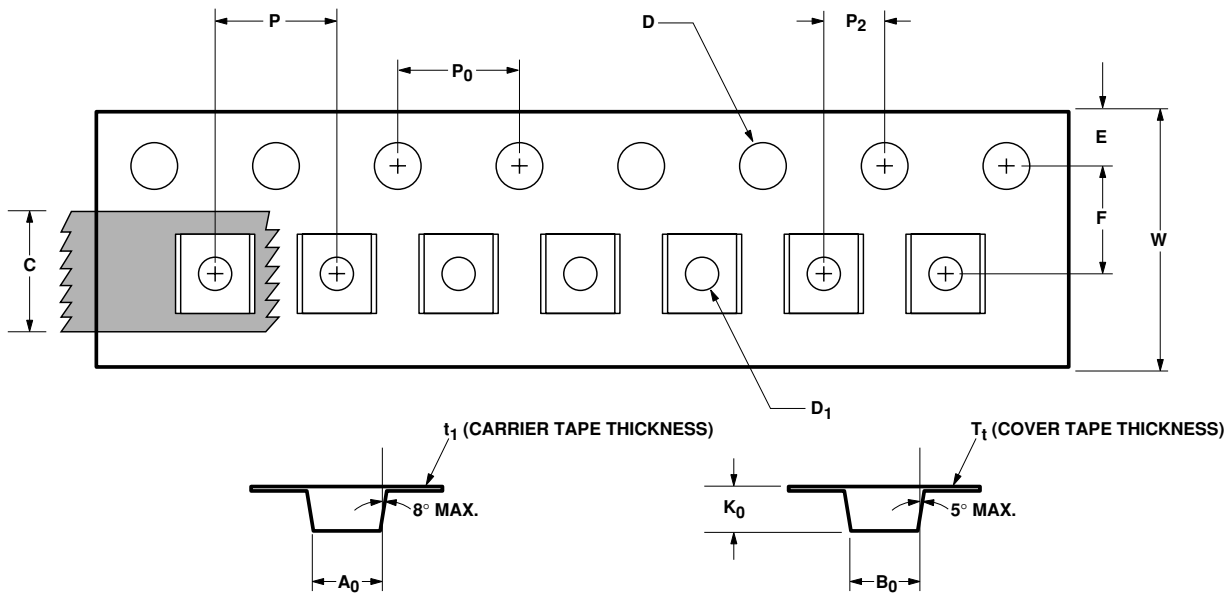

	DESCRIPTION	SYMBOL	SIZE (mm)	SIZE (INCHES)
CAVITY	LENGTH	A ₀	2.24 ± 0.10	0.088 ± 0.004
	WIDTH	B ₀	2.34 ± 0.10	0.092 ± 0.004
	DEPTH	K ₀	1.22 ± 0.10	0.048 ± 0.004
	PITCH	P	4.00 ± 0.10	0.157 ± 0.004
	BOTTOM HOLE DIAMETER	D ₁	1.00 ± 0.25	0.039 ± 0.010
PERFORATION	DIAMETER	D	1.55 ± 0.05	0.061 ± 0.002
	PITCH	P ₀	4.00 ± 0.10	0.157 ± 0.004
	POSITION	E	1.75 ± 0.10	0.069 ± 0.004
CARRIER TAPE	WIDTH	W	8.00 ± 0.30	0.315 ± 0.012
	THICKNESS	t ₁	0.255 ± 0.013	0.010 ± 0.0005
COVER TAPE	WIDTH	C	5.4 ± 0.10	0.205 ± 0.004
	TAPE THICKNESS	T _t	0.062 ± 0.001	0.0025 ± 0.00004
DISTANCE	CAVITY TO PERFORATION (WIDTH DIRECTION)	F	3.50 ± 0.05	0.138 ± 0.002
	CAVITY TO PERFORATION (LENGTH DIRECTION)	P ₂	2.00 ± 0.05	0.079 ± 0.002

For product information and a complete list of distributors, please go to our web site: www.avagotech.com

Avago, Avago Technologies, and the A logo are trademarks of Avago Technologies, Limited in the United States and other countries. Data subject to change. Copyright © 2007 Avago Technologies Limited. All rights reserved. Obsoletes 5980-2396E 5989-4220EN - October 25, 2007

Avago
TECHNOLOGIES