

**VIDEO INTERFACE CONTROLLER
FOR TFT PANEL**

Model: AVP-1600

Part number : 41722000X-3

INSTRUCTIONS

CONTENTS

Page: **2. Introduction, How to Proceed, Usage Note, Disclaimer**
3. System design – Diagram of a suggested system
4. Assembly notes – Important information about system elements
7. Connection & Operation – How to use the controller
11. Connectors, pinouts & jumpers – Essential connection information
19. Controller dimensions
20. Application notes
22. Troubleshooting
23. Specifications
24. Appendix I – Video Mode Support Table
25. Appendix II – RS-232 control protocols
29. Appendix III – Mapping definition
31. Appendix V – DV remote control unit work for AVP-1600
32. Appendix VI – Specification for Audio Add-on Board P/N 416940020-3
34. Warranty, Caution & Limitation of Liability, Trademarks
35. Contact details

It is essential that these instructions are read and understood before connecting or powering up this controller.

Introduction

Designed for LCD monitor and other flat panel display applications, the AVP-1600 controller is an easy to use interface controller for:

- Composite and S-Video input of PAL, NTSC, SECAM video sources.
- Jumper selectable for two S-Video & two composite video or four composite video input.
- TFT (active matrix) LCDs with LVDS / TTL single pixel interface LCD resolutions from 1600x1200 to 640x480.
- Volume control of audio (optional add-on board required)
- DigitalView IR remote control support
- 12v or 24v DC power input.
- Comprehensive RS-232 protocols

HOW TO PROCEED

- As most panels require different connection settings and cables it is important to have the relevant Digital View Connection Diagram before assembly begins. This is obtainable from the Digital View website as follows:

Controller Solution Generator

A web based resource matching controllers & panels with **connection diagrams** for download. Visit : <http://www.digitalview.com/controllers/csg.php>

- Ensure all parts are on hand.
- Check controller and add-on board switch & jumper settings (errors may damage the panel)
- Prepare the source
- Connect the parts
- Understand the operation & functions

IMPORTANT USAGE NOTE

This product is for use by system developers and integrators, the manufacturer accepts no liability for damage or injury caused by the use of this product. It is the responsibility of the developer, integrators or other user of this product to:

- Ensure that all necessary and appropriate safety measures are taken.
- Obtain suitable regulatory approvals as may be required.
- Check power settings to all component parts before connection.
- Understand the operation and connectivity requirements of this controller.

DISCLAIMER

There is no implied or expressed warranty regarding this material.

SYSTEM DESIGN

A typical LCD based display system utilizing this controller is likely to comprise the following:

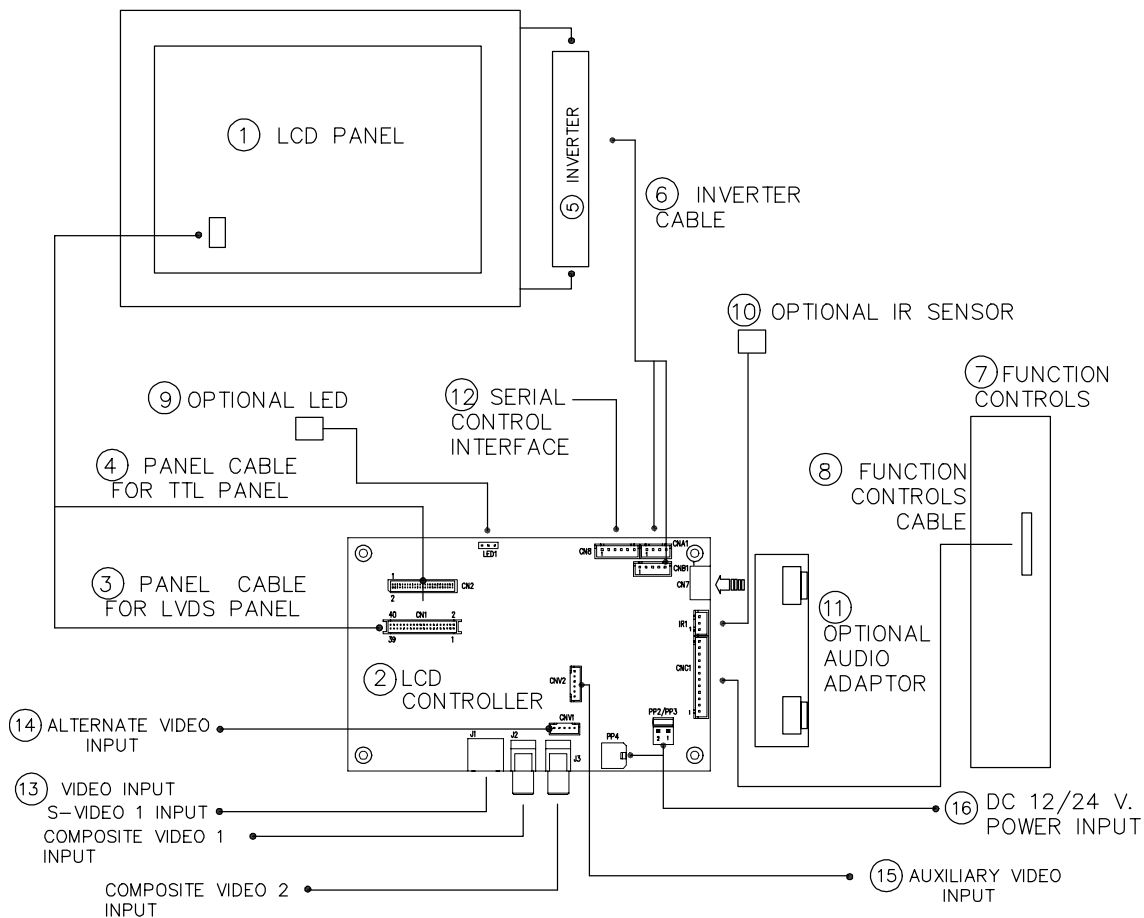

Summary:

1. LCD panel
2. LCD controller card, AVP-1600
3. LVDS cable (for connection with LVDS panel)
4. TTL cable (for connection with TTL panel)
5. Inverter for CCFT backlight (if not built into LCD)
6. Inverter cable
7. Function controls
8. Function controls cable
9. Status LED (Optional)
10. IR sensor (Optional)
11. Audio add-on board (optional)
12. RS-232 control interface
13. AV cable (J1 : S-Video 1, J2 : Composite video 1, J3 : Composite video 2)
14. Alternate video input (Composite video 1 / S-Video 1 input)
15. Auxiliary video input (Jumper selectable - Composite video 2-4 / Composite video 2 & S-Video 1 & 2)
16. Power input (12VDC / 24VDC)

Digital View offers a range of accessories such as listed above, to make up complete display solution.

ASSEMBLY NOTES

This controller is designed for monitor and custom projects with PAL, NTSC, SECAM video sources over Composite or S-Video using 1600x1200 or 1400x1050 or 1366x768 or 1280x1024 or 1280x800 or 1280x768 x 1024x768 or 800x600 or 800x480 or 640x480 resolution TFT type LCD panels display with TTL or LVDS inputs. The following provides some guidelines for installation and preparation of a finished display solution.

Preparation: Before proceeding it is important to familiarize yourself with the parts making up the system and the various connectors, mounting holes and general layout of the controller. As much as possible connectors have been labeled. Guides to connectors and mounting holes are shown in the following relevant sections.

- 1. LCD Panel:** This controller is designed for typical LVDS or TTL single interface panels with panel voltage 3.3V, 5V, 12V or 18V Due to the variation between manufacturers of panels signal timing and other panel characteristics, factory setup and confirmation should be obtained before connecting to a panel by reference to the original panel manufacturers panel specification and download of the connection diagram from Digital View Controller Solution Generator at www.digitalview.com . **(NOTE: Check panel power jumper settings before connection)**
- 2. Controller:** Handle the controller with care as static charge may damage electronic components. Make sure correct jumper and dip switches settings to match the target LCD panel.
- 3. LCD signal cable (LVDS panel):** In order to provide a clean signal it is recommended that LVDS signal cables are no longer than 46cm (18 inches). If those wire cabling is utilized these can be made into a harness with cable ties. Care should be taken when placing the cables to avoid signal interference. Additionally it may be necessary in some systems to add ferrite cores to the cable to minimize signal noise.
- 4. LCD signal cable (Single pixel TTL panel):** In order to provide a clean signal it is recommended that LCD signal cables should not longer than 33cm (13 inches). If loose wire cabling is utilized these can be made into a harness with cable ties. Care should be taken when placing the cables to avoid signal interference. Additionally it may be necessary in some systems to add ferrite cores to the cables to minimize signal noise.
- 5. Inverter:** This will be required for the backlight of an LCD, some LCD panels have an inverter built in. As LCD panels may have 1 or more backlight tubes and the power requirements for different panel backlights may vary it is important to match the inverter in order to obtain optimum performance. See Application notes page 18 for more information on connection.
- 6. Inverter Cables:** Different inverter models require different cables and different pin assignment. Make sure correct cable pin out to match inverter. Using wrong cable pin out may damage the inverter.
- 7. Function Controls:** The following section discusses the controls required and the section on connectors provides the detail. The controls are minimal: On/Off, Backlight Brightness (depends on inverter), OSD (5 momentary buttons) analog VR type or (8 momentary buttons) digital type.
- 8. Function controls cable:** The cables to the function switches should be of suitable quality and length so that impedance does not affect performance. Generally lengths up to 1 meter (3 feet) should be acceptable.

9. **Controller status LED (Optional)** : This LED indicates the controller status. The pin direction of the LED should be corrected for right color indication. Red color stands for standby. Green colors stands for signal on. The status LED is an optional part only, can be unconnected.

Controller LED status (LED1) :

State	LED color
No signal & backlight off	RED
No signal & backlight on	ORANGE
With signal & backlight on	GREEN

10. **IR sensor**: It is an optional part only, can be unconnected if not using IR remote control.
11. **Audio add-on board P/N 416040010-3**: The audio add-on board gives the audio input and output signal connection. It is an optional part only, can be unconnected if not using audio.
CAUTION : The Audio Add-on Board P/N 416940020-3 can only operate with 12VDC power input environment.
12. **RS-232 control interface** : The RS-232 protocols shown in Appendix II.
13. **S-Video 1 / Composite 1 / Composite 2 : AV cables**: Standard Composite video or S-video cables can be used. Reasonable quality cable should be used to avoid image quality degradation.
14. **Alternate video input** : Support alternate composite video 1 / S-Video 1 input on CNV1 connector.
15. **Auxiliary video input** : This port provides Composite video 2-4 or Composite video 2 & S-video 2 (JP2 jumper selectable). The video input selection can be switched via OSD menu or RS-232 command (0x98).

JP2 jumper setting	OPEN	CLOSED
Video input configuration on CNV2	Composite video 2 & S-Video 2 support	Composite video 2-4 support

16. **12V / 24VDC power input** :
- **Power Input**: 12V DC / 24VDC is required, this should be a regulated supply. The power rating is depending on the panel and inverter used. Normally, power supply with 3.5Amp current output should enough for most of 4x CCFT panels. Although the controller provides power regulation for the LCD power this does not relate to the power supplied to the backlight inverter. If an unregulated power supply is provided to an inverter any fluctuations in power may affect operation, performance and lifetime of the inverter and or backlight tubes.
24VDC input is required when the panel output voltage is 18VDC. Please refer to page 11-12 for proper jumper settings.
 - **Power output**: Note the controller has an overall 3Amp current limit and the current available from the auxiliary power output will be dependent on the power input and other system requirements.
 - **Power Safety**: Note that although only 12VDC / 24VDC is required as 'power-in' a backlight inverter for panel backlighting produces significantly higher voltages (the inverter does not connect to the ground plane). We strongly advise appropriate insulation for all circuitry.
 - **EMI**: Shielding will be required for passing certain regulatory emissions tests.
 - **Ground**: The various PCB mounting holes are connected to the ground plane.
 - **Servicing**: The board is not user serviceable or repairable. Warranty does not cover user error in connecting up to the controller and is invalidated by unauthorized modification or repairs.
 - **Controller Mounting**: It is recommended that a clearance of at least 10mm is provided above and 5mm below the controller when mounted. Additionally consideration should be given to:

Specifications subject to change without notice

- Electrical insulation.
- Grounding.
- EMI shielding.
- Cable management. Note: It is important to keep panel signal cables apart from the inverter & backlight cables to prevent signal interference.
- Heat & Ventilation: Heat generated from other sources, for example the backlight of a very high brightness panel may generate significant heat which could adversely affect the controller.
- Other issues that may affect safety or performance.

IMPORTANT: Please read the Application Notes section for more information.

CONNECTION & OPERATION

CAUTION: Never connect or disconnect parts of the display system when the system is powered up as this may cause serious damage.

CONNECTION

Connection and usage is quite straight forward (it is useful to have the relevant connection diagram available at this time):

1. **LCD panel & Inverter:** Connect the inverter (if it is not built-in the panel) to the CCFT lead connector of the LCD panel.
2. **LVDS type panels:** Plug the LVDS signal cable direct to CN1 (if necessary). Insert the panel end of the cable to the LCD panel connector.
3. **TTL single pixel type panels:** Plug the signal cables direct to CN2. Plug the other end of cables to the LCD connector board (if connector board is required, otherwise the signal can be direct plug to the LCD panel connector). Then plug the board connector to the LCD panel connector.
4. **Inverter & Controller:** Plug the inverter cable to CNB1 and CNA1 (if necessary). Plug another end to the connector on the inverter.
5. **Function switch & Controller:** Plug the OSD switch mount cable to CNC1 on the controller board and another to the OSD switch mount.
6. **LED 1 :** Plug in a 3-way with dual color LED to connector LED1 on the controller board for indicating the controller status.
7. **IR & Controller:** Plug in a 3-way with IR sensor to connector IR1 on the controller board.
8. **Jumpers :** Check all jumpers are set correctly. Details referring the connection diagram at <http://www.digitalview.com/controllers/csg.php>
9. **Jumpers & Inverter & Panel voltage:** Particularly pay attention to the settings of JA3, JA6, JB2, JB3. JB2 & JB3 are used for inverter control (read inverter specification and information on the jumper table to define the correct settings). JA3 & JA6 are used for panel voltage input (read panel specification and information on the jumper table to define the correct settings).
10. **Video input configuration selection on CNV2 :** Enable Composite video 2 & S-Video 2 inputs support on CNV2 when setting JP2 open. Enable Composite video 2 -4 inputs support when setting JP2 closed.
11. **Power supply & Controller:** Plug the DC 12V / 24V power in to the connector PP2. You can consider to use DigitalView mating power cable P/N 426013800-3, 160mm. Please read the jumper table in page 11-12 to define the correct settings. Otherwise it may break down the panel.
12. **Power on:** Switch on the controller board and panel by using the OSD switch mount.

CAUTION: Never connect or disconnect parts of the display system when the system is powered up as this may cause serious damage.

Controller LED status (LED1) :

State	LED color
No signal & backlight off	RED
No signal & backlight on	ORANGE
With signal & backlight on	GREEN

General:

- If you are using supplied cables & accessories, ensure they are correct for the model of panel and controller.
- If you are making your own cables & connectors refer carefully to both the panel & inverter specifications and the section in this manual, "Connectors, Pinouts & Jumpers" to ensure the correct pin to pin wiring.

OPERATION

Once the system has been connected and switched on there are a number of functions available to adjust the display image as summarized in the following sections. The settings chosen will be saved for each mode independently.

Specifications subject to change without notice

© Digital View Ltd – Doc Ver 1.2: 3 Dec, 2010 (AVP-1600_manual.doc)

Page 7 of 35

LCD DISPLAY SYSTEM SETTINGS

NOTE: By way of explanation the following refers to a set of sample buttons that may be obtained as an option. In addition to power on/off and connection for backlight brightness the controller provides an On Screen Display of certain functions which are controlled by 5 momentary type buttons (analog VR type) or 8 momentary type buttons (digital type):

Controls	Analog VR type	Digital type
On/Off – turns controller board power on	VR toggle switch	On/Off button
Brightness – controls backlight brightness	Rotary VR	Brightness +/- buttons
Menu – turns OSD menu On or Off (it will auto time off) (Function with signal input only)	Menu button	Menu button
Select – Select function / Confirm (under OSD menu on state)	SEL DN	SEL DN
Move up to select individual RGB color level OSD page (under OSD menu on state)	SEL UP	SEL UP
+ – increase the setting / moves the selector to the next function (under OSD menu on state)	+	+
- - decrease the setting / moves the selector to the previous function (under OSD menu on state)	-	-
Load factory default	Press and hold SEL DN button to power on the controller	Press and hold SEL DN button to power on the controller
Lock OSD menu (Function with signal input only)	Press and hold MENU button for 15 seconds to enable / disable lock of the OSD menu	Press and hold MENU button for 15 seconds to enable / disable lock of the OSD menu
Switch to next input source (under OSD menu off state)	+	+

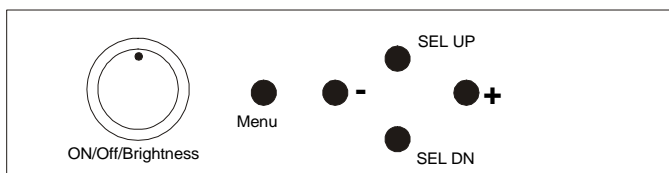

Analog VR type

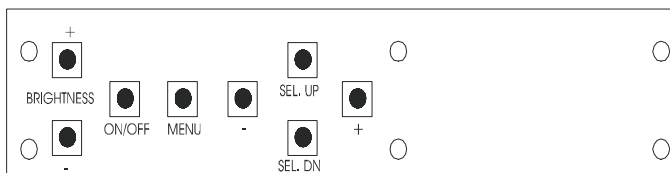

































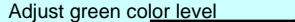

Digital type













OSD Functions

Selection page			
Select input source ▶			
When JP2 = OPEN			
			Select input source to S-Video 1
			Select input source to Composite 1
			Select input source to S-Video 2
			Select input source to Composite 2
When JP2 = CLOSED			
			Select input source to Composite 1

Specifications subject to change without notice

		Select input source to Composite 2
		Select input source to Composite 3
		Select input source to Composite 4
	Auto Source Seek	ON – Auto source select always enable OFF – Disable auto source select function
	Video system selection* ▶	
		Select Auto video system detection
		Select PAL video system
		Select PAL M video system
		Select NTSC video system
		Select NTSC 4.43 video system
		Select SECAM video system
	Exit	Exit the OSD menu and save the settings
Brightness and Contrast		
	Brightness	Increase/decrease brightness level. Press – or + (-  +) Total : 256 steps
	Contrast	Increase/decrease panel contrast level. Press – or + (-  +) Total : 192 steps
	Saturation	Increase/decrease hue level. Press – or + (-  +) Total : 256 steps
	Hue	Increase/decrease saturation level Press – or + (-  +) Total : 128 steps
	Exit	Exit the OSD menu and save the settings
Color		
	Color Temperature ▶	(Adjust the warmth of the image displayed. The higher temperature the coolest image looks like. The lower temperature the warmest image looks like.)
		Adjust red color level Press – or + (-  +) Total :128 steps Adjust green color level Press – or + (-  +) Total : 128 steps Adjust blue color level Press – or + (-  +) Total : 128 steps Press SEL UP/DN button to select item
		Set the color temperature to 4200K
		Set the color temperature to 5000K
		Set the color temperature to 6500K
		Set the color temperature to 7500K
		Set the color temperature to 9300K
	Gamma adjustment ▶	Adjust Gamma settings (0.4 / 0.6 / 1.0 / 1.6 / 2.2)
		Select Gamma to 0.4
		Select Gamma to 0.6
		Select Gamma to 1.0

Specifications subject to change without notice

		1.6	Select Gamma to 1.6
		2.2	Select Gamma to 2.2
		Exit	Exit the OSD menu and save the settings
	Utilities		
		OSD setting ▶	
			OSD Timeout : 0 / 10 / 20 / 30 / 40 / 50 / 60 seconds (Always on when set to 0) Press – or + (- <input type="text"/> +)
			OSD menu horizontal position Press – or + (- <input type="text"/> +)
			OSD menu vertical position Press – or + (- <input type="text"/> +)
		Load Factory Default	Initialize the setting stored in non-volatile memory
		Sharpness	Adjust sharpness level Press – or + (- <input type="text"/> +) Total : 49 steps
		Exit	Exit the OSD menu
			
		Volume adjustment	Volume level adjustment Press – or + (- <input type="text"/> +) Total : 100 steps
		Exit	Exit the OSD menu
	Exit the OSD menu		

[Firmware version : V1.00.00 or up]

Items marked ▶ have sub menus.
Exit the OSD menu to save the setting chosen

CONNECTORS, PINOUTS & JUMPERS

The various connectors are:

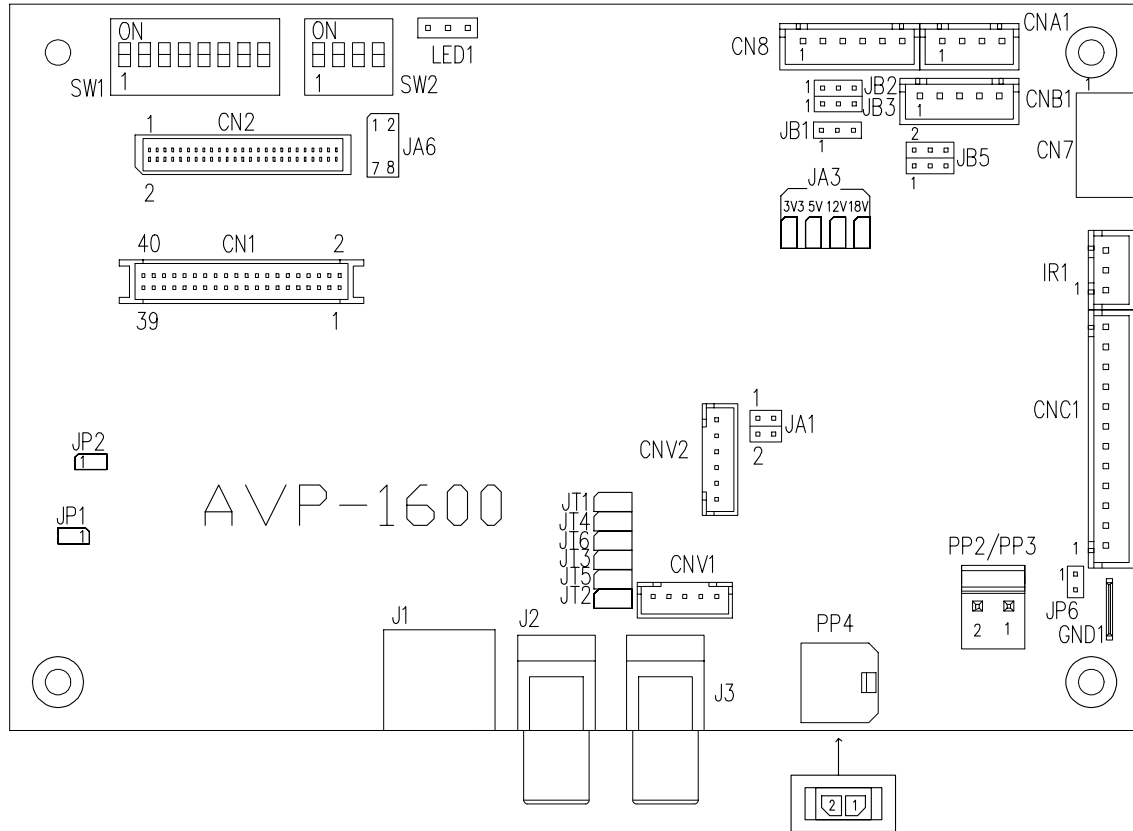

Summary: Connectors

Ref	Purpose	Description
CN1	LVDS panel signal	Hirose 40-pin, DF13-40DP-1.25DSA (Mating type : DF13-40DS-1.25C)
CN2	TTL panel signal	Hirose 40-pin, DF20G-40DP-1V (Mating type : DF20A-40DS-1C)
CN7	Audio board connector	DIL socket header 5x2 right angle
CN8	RS-232 serial control	JST 6-way, B6B-XH-A (Matching type : XHP-6)
CNA1	Auxiliary power output	JST 4-way, B4B-XH-A (Mating type : XHP-4)
CNB1	Backlight inverter	JST 5-way, B5B-XH-A (Mating type : XHP-5)
CNC1	Function controls	JST 12-way, B12B-XH-A (Mating type : XHP-12)
CNV1	Alternate Composite 1 / S-Video 1 video in	JST 5-way, B5B-PH-K (Matching type : PHR-5) (Matching video cable : P/N 426000500-3)
CNV2	Auxiliary video input	JST 6-way, B6B-PH-K (Matching type : PHR-6) (Matching video cable for composite 2 - 4) : P/N 426002300-3 (Matching video cable for composite 2 & S-Video 2 : P/N 426007300-3)
IR1	Infra-Red sensor connector	JST 3-way, B3B-XH-A (Matching type : XHP-3)
LED1	Dual color LED connector for controller status	Header pin 3x1
PP2/PP3	Power input (alternative)	DC power Molex 2 pin 0.156" pitch
PP4	Power input	Molex 43650-0200 compatible (Mating type : Molex 43645-0200 compatible) (Matching power cable : P/N 426013800-3)
J1	S-video 1 in	Mini din 4-way
J2	Composite video 1 in	BNC connector
J3	Composite video 2 in	BNC connector

Specifications subject to change without notice

© Digital View Ltd – Doc Ver 1.2: 3 Dec, 2010 (AVP-1600_manual.doc)

Page 11 of 35

Summary: Jumpers setting

Ref	Purpose	Note
JA1	On board +5V logic power enable	1-3 & 2-4 closed, factory set, do not remove
JA3	Panel power voltage select	See panel voltage setting table 1 CAUTION: Incorrect setting will cause panel damage
JA6	Panel power voltage select	See panel voltage setting table 1 CAUTION: Incorrect setting will cause panel damage
JB1	Backlight brightness voltage range	1-2 closed = 3.3V max 2-3 closed = 5V max
JB2	Backlight inverter on/off control – signal level	2-3 = On/Off control signal 'High' = +5V 1-2 = On/Off control signal 'High' = +3.3V Open = On/Off control signal 'High' = Open collector CAUTION: Incorrect setting can damage inverter.
JB3	Backlight inverter on/off control – polarity	1-2 = control signal 'high' = CCFT ON 2-3 = control signal 'low' = CCFT ON
JB5	Backlight control type selection	1-2 = VR/Digital switch mount control 3-4 = Analog backlight brightness control via RS-232 command (0xe0) – voltage range 0-5V 5-6 = Reserved
JP1	Reserved	Reserved for internal programming use (Always 1-2 closed)
JP2	Video input configuration selection	Open = Composite 2 & S-Video 2 inputs support Closed = Composite video 2-4 inputs support
JP6	Input power control	Short = External switch control Open = Switch mount control
JT1	Composite 2 video-in terminator enable	Open = composite video 2 input is not terminated Close = composite video 2 input is terminated with 75Ω
JT2	Composite 1 video-in terminator enable	Open = composite video 1 input is not terminated Close = composite video 1 input is terminated with 75Ω
JT3	S-Video 1 chroma-in terminator enable	Open = S-video 1 chroma input is not terminated Close = S-video 1 chroma input is terminated with 75Ω
JT4	S-Video 2 chroma-in terminator enable	Open = S-video 2 chroma input is not terminated Close = S-video 2 chroma input is terminated with 75Ω
JT5	S-Video 1 luma-in terminator enable	Open = S-video 1 luma input is not terminated Close = S-video 1 luma input is terminated with 75Ω
JT6	S-Video 2 luma-in terminator enable	Open = S-video 2 luma input is not terminated Close = S-video 2 luma input is terminated with 75Ω
SW1	Panel selection	See table below
SW2	Panel selection	See table below

Table 1 : Panel voltage setting table :

Input voltage via PP2	Panel Voltage	JA3	JA6	Jumper on board
12VDC	3.3V	3V3 closed	1-3 & 2-4	
	5V	5V closed	1-3 & 2-4	
	12V	OPEN	5-7 & 6-8	

CAUTION: Incorrect setting can damage panel & controller

Input voltage via PP2	Panel Voltage	JA3	JA6	Jumper on board
24VDC**	3.3V	3V3 closed	1-3 & 2-4	
	5V	5V closed	1-3 & 2-4	
	12V	12V closed	3-5 & 4-6	
	18V	18V closed	3-5 & 4-6	

CAUTION: Incorrect setting can damage panel & controller

**** Please make sure the backlight inverter must support 24V supply. Because CNA1 pin 1 and CNB1 pin 2 will output 24VDC if input 24VDC via PP2.**

JA3 & JA6 location on board : (Please pay attention to the jumper settings on JA3 & JA6 which are red in color)

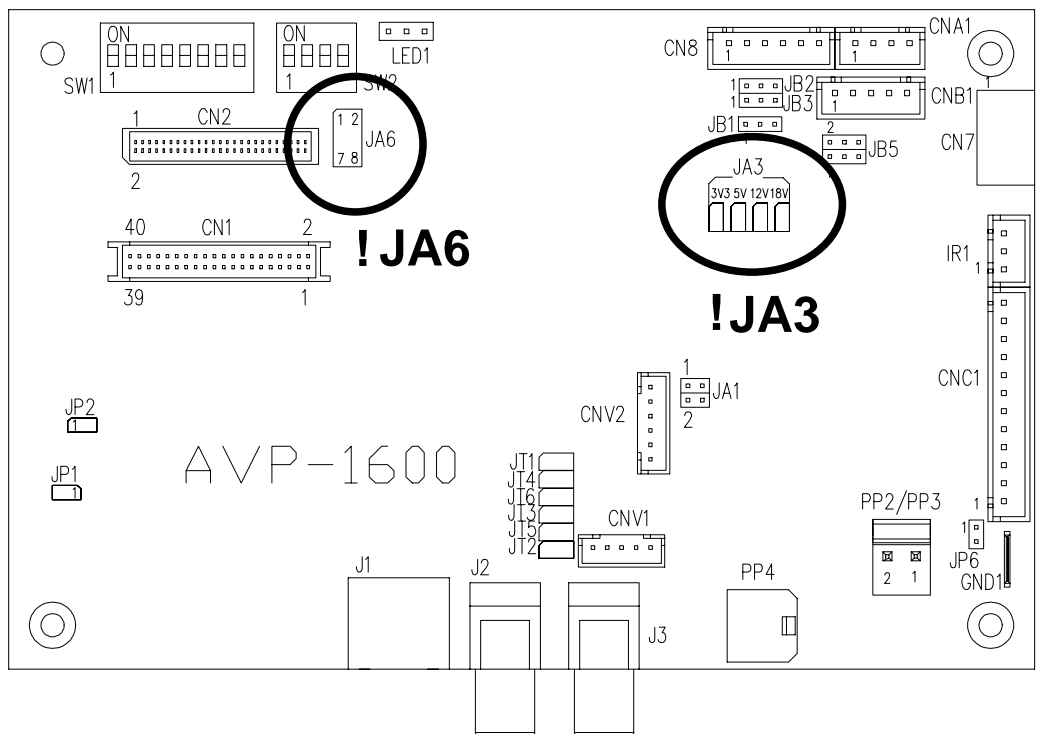

Specifications subject to change without notice

© Digital View Ltd – Doc Ver 1.2: 3 Dec, 2010 (AVP-1600_manual.doc)

Page 13 of 35

DIP Switch selection – SW1

Pos #1	Pos #2	Pos #3	Pos.#4	Description	Panel resolution
For WUXGA					
OFF	OFF	OFF	OFF	AU Optronics B170UW02 V0	1920x1200
For UXGA panel					
OFF	OFF	OFF	OFF	Fujitsu FLC59UXC8V-02A	1600x1200
ON	OFF	OFF	OFF	NEC NL160120BC27-14 (Tested)	1600x1200
For WXGA panel					
ON	ON	ON	OFF	AU Optronics M220EW01	1680x1050
ON	OFF	OFF	OFF	Samsung LTA260W2-L01 ** (Tested)	1366x768
OFF	ON	OFF	OFF	NEC NL12876BC26-21	1280x768
ON	ON	OFF	OFF	Samsung LTA460WS-L03	1366x768
OFF	OFF	ON	OFF	Sharp LQ315T3LZ24	1366x768
ON	OFF	ON	OFF	LG LC420W02-A4	1366x768
OFF	ON	ON	OFF	NEC NL12880BC20-02D * (Tested)	1280x800
For SXGA panels					
ON	OFF	OFF	ON	NEC NL128102BC29-01B (Tested)	1280x1024
ON	ON	ON	OFF	Fujitsu FLC48SXC8V	1280x1024
OFF	ON	OFF	ON	Sharp LQ181E1LW31** (Tested)	1280x1024
For XGA panel					
OFF	OFF	ON	ON	AUO M150XN07 V2 * (Tested)	1024x768
OFF	ON	ON	OFF	LG LM151X2	1024x768
ON	ON	OFF	ON	Sharp LQ150X1LGB1 Sharp LQ150X1LGN2A	1024x768 1024x768
ON	OFF	ON	ON	NEC NL10276BC12-02	1024x768
OFF	ON	ON	ON	NEC NL10276BC13-01C* (Tested)	1024x768
ON	ON	ON	ON	NEC NL10276BC30-18C** (Tested) NEC NL10276BC20-08** (Tested)	1024x768 1024x768
For SVGA panel					
OFF	OFF	ON	OFF	PrimeView PD104SL5H2 (Tested) Sharp LQ121S1DG11 (Tested) Sharp LQ104S1DG21 Sharp LQ121S1DG41	800x600 800x600 800x600 800x600
ON	OFF	ON	OFF	Toshiba LTM12C289 (Tested)	800x600
OFF	ON	ON	OFF	Sharp LQ084S3DG01** (Tested)	800x600
ON	ON	OFF	OFF	Sharp LQ121S1LG41 (Tested) NEC NL8060BC21-02** (Tested)	800x600 800x600
ON	ON	ON	OFF	Sharp LQ104S1DG21** (Tested)	800x600
For WVGA panel					
ON	ON	OFF	OFF	Kyocera TCG085WV1AB (Tested)	800x480
ON	OFF	ON	OFF	NEC NL8048BC19-02 ** (Tested)	800x480
For VGA panel					
ON	OFF	OFF	OFF	Sharp LQ10D368 (Tested) Sharp LQ104V1DG51 (Tested) Sharp LQ104V1DG21	640x480 640x480 640x480
OFF	OFF	ON	OFF	PrimeView PD064VT5*(Tested) NEC NL6448BC26-01*(Tested)	640x480 640x480
OFF	ON	ON	OFF	Sharp LQ10D421	640x480
ON	ON	ON	OFF	LG LP104V2	640x480
OFF	OFF	OFF	ON	AU Optronics G104VN01	640x480
ON	OFF	OFF	ON	Sharp LQ070Y3LG4A	640x480
Others					
ON	OFF	OFF	OFF	Sharp LQ150F1LH22** (Tested)	1400x1050
OFF	ON	OFF	OFF	Sharp LS037V7DW03 ** (Tested)	480x640

For additional and recent added panels, see AVP-1600 panel support table at <http://www.digitalview.com/controllers/csg.php>

Pos #5	Pos #6	Pos #7	Description
ON	OFF	OFF	UXGA
OFF	ON	OFF	SXGA
ON	ON	OFF	WXGA
OFF	OFF	ON	XGA
ON	OFF	ON	SVGA
OFF	ON	ON	VGA / WVGA
ON	ON	ON	Others

SW1 Pos 8 = Reserved.

DIP switch selection – SW2

Pos. #	Function	Description
1	Panel pixel format	OFF : Double Pixel ON : Single Pixel
2	LVDS data mapping select	ON : Mapping A (LVDS panel) OFF : Mapping B (LVDS panel) Please adjust to get the correct picture. See as Appendix II for details of mapping A and B.
3	Volume adjustment OSD menu page*	ON : Enable OFF : Disable
4	Selection of TTL / LVDS panel connection	ON : LVDS OFF : TTL

* Support in V1.03.00 or up firmware version or up only.

The most current list can be found the controller solution generator at <http://www.digitalview.com/controllers/csg.php>

CN1 – Panel connector: Hirose, DF13A-40DP-1.25DSA (Matching type : DF13-40DS-1.25C)

PIN	SYMBOL	DESCRIPTION
1	TXA0+	Positive differential LVDS data bit A0
2	TXA0-	Negative differential LVDS data bit A0
3	TXA1+	Positive differential LVDS data bit A1
4	TXA1-	Negative differential LVDS data bit A1
5	NC	No connection
6	NC	No connection
7	TXA2+	Positive differential LVDS data bit A2
8	TXA2-	Negative differential LVDS data bit A2
9	TXA3+	Positive differential LVDS data bit A3
10	TXA3-	Negative differential LVDS data bit A3
11	GND	Ground
12	GND	Ground
13	TXAC+	Positive LVDS clock for A channel
14	TXAC-	Negative LVDS clock for A channel
15	GND	Ground
16	GND	Ground
17	TXB0+	Positive differential LVDS data bit B0
18	TXB0-	Negative differential LVDS data bit B0
19	TXB1+	Positive differential LVDS data bit B1
20	TXB1-	Negative differential LVDS data bit B1
21	NC	No connection
22	NC	No connection
23	TXB2+	Positive differential LVDS data bit B2
24	TXB2-	Negative differential LVDS data bit B2
25	TXB3+	Positive differential LVDS data bit B3
26	TXB3-	Negative differential LVDS data bit B3
27	GND	Ground
28	GND	Ground
29	TXBC+	Positive LVDS clock for B channel
30	TXBC-	Negative LVDS clock for B channel
31	GND	Ground
32	GND	Ground
33	VDD (3,3V/5V)	Panel power supply (3,3V/5V) (selected by JA3 & JA6)
34	VDD (3,3V/5V)	Panel power supply (3,3V/5V) (selected by JA3 & JA6)
35	VDD (3,3V/5V)	Panel power supply (3,3V/5V) (selected by JA3 & JA6)
36	VDD (3,3V/5V)	Panel power supply (3,3V/5V) (selected by JA3 & JA6)
37	NC	No connection
38	VDD (+12V/18V)	Panel power supply (+12V / 18V) (selected by JA3 & JA6)
39	VDD (+12V/18V)	Panel power supply (+12V / 18V) (selected by JA3 & JA6)
40	VDD (+12V/18V)	Panel power supply (+12V / 18V) (selected by JA3 & JA6)

CN2 – Panel connector: HIROSE DF20G-50DP-1V (Matching type : DF20A-50DS-1C)

PIN	SYMBOL	DESCRIPTION
1	GND	Ground
2	GND	Ground
3	NC	No connection
4	NC	No connection
5	RA0	Data bit R0
6	RA1	Data bit R1
7	RA2	Data bit R2
8	RA3	Data bit R3
9	RA4	Data bit R4
10	RA5	Data bit R5
11	RA6	Data bit R6
12	RA7	Data bit R7
13	GND	Ground
14	GND	Ground
15	NC	No connection
16	NC	No connection
17	GA0	Data bit G0
18	GA1	Data bit G1
19	GA2	Data bit G2
20	GA3	Data bit G3
21	GA4	Data bit G4
22	GA5	Data bit G5
23	GA6	Data bit G6
24	GA7	Data bit G7
25	GND	Ground

Specifications subject to change without notice

26	GND	Ground
27	NC	No connection
28	NC	No connection
29	BA0	Data bit B0
30	BA1	Data bit B1
31	BA2	Data bit B2
32	BA3	Data bit B3
33	BA4	Data bit B4
34	BA5	Data bit B5
35	BA6	Data bit B6
36	BA7	Data bit B7
37	GND	Ground
38	GND	Ground
39	VS	Vertical sync
40	CLK	Dot clock
41	HS	Horizontal sync
42	DE	Display enable
43	PWR	Power down control signal (5v TTL)
44	VLCD	Panel power supply (3,3V/5V) (selected by JA3 & JA6)
45	VLCD	Panel power supply (3,3V/5V) (selected by JA3 & JA6)
46	VLCD	Panel power supply (3,3V/5V) (selected by JA3 & JA6)
47	NC	No connection
48	VLCD12/18	+12V/18V panel supply (selected by JA3 & JA6)
49	VLCD12/18	+12V/18V panel supply (selected by JA3 & JA6)
50	VLCD12/18	+12V/18V panel supply (selected by JA3 & JA6)

CN7 - Audio connector: DIL socket header 5x2 right angle [OPERATE UNDER 12VDC POWER INPUT ENVIRONMENT]

PIN	SYMBOL	DESCRIPTION
1	VCC	Audio board logic power supply, +5V
2	VOLSEL0	Reserved
3	VOLSEL1	Reversed
4	TUNAUSEL	Reserved
5	CLK/CNT	Reserved
6	GND	Ground
7	+12V/+24V	Audio board power supply, +12V/+24V
8	NC	No connection
9	NC	No connection
10	GND	Ground

CN8 – RS-232 serial control: JST B6B-XH-A (Matching type : XHP-6)

PIN	SYMBOL	DESCRIPTION
1	SDATA	Reserved
2	SCLK	Reserved
3	VCC	+5V
4	TXD	RS-232 Tx data
5	GND	Ground
6	RXD	RS-232 Rx data

CNA1 - Auxiliary power output: JST B4B-XH-A (Matching type : XHP-4)

PIN	SYMBOL	DESCRIPTION
1	AUX POWER	+12V DC, 500mA max / +24V DC, 3A max
2	GND	Ground
3	GND	Ground
4	AUX 5V	+5V DC, 500mA max

CNB1 – Backlight inverter connector: JST B5B-XH-A (Matching type : XHP-5)

PIN	SYMBOL	DESCRIPTION
1	GND	Ground
2	VBKL	Backlight power supply, +12VDC / +24V DC, 3A max
3	BLCTRL	Backlight On/Off control signal (refer to JB2 & JB3)
4	BVR_WIP	Backlight brightness VR pin WIP
5	BVR_A	Backlight brightness VR pin A

CNC1 – Control switch, JST B12B-XH-A

PIN	SYMBOL	DESCRIPTION
1	PSWIN	Power button A
2	SW_ON	Power button B
3	BVR_A	Backlight Brightness VR pin A
4	BVR_WIP	Backlight Brightness R pin WIP
5	BVR_B	Backlight Brightness VR pin B (470 ohm resistor to +5V Vcc)
6	GND	Ground

Specifications subject to change without notice

7	MENU	OSD menu
8	-/LEFT	OSD -/Left
9	+/RIGHT	OSD +/Right
10	SEL_DN	OSD Select down
11	SEL_UP	OSD Select up
12	NC	No connection

CNV1 – Alternate Video in input, JST B5B-PH-K (Matching type : PHR-5)

PIN	DESCRIPTION
1	S-Video 1 : Chroma in
2	S-Video 1 : Luma in
3	Ground
4	Ground
5	Composite video 1 in

CNV2 – Auxiliary Video in input, JST B6B-PH-K (Matching type : PHR-6)

PIN	DESCRIPTION
1	Composite video 2 in (selected by JP2)
2	Ground
3	Composite video 3 in / S-Video : Chroma in (selected by JP2)
4	Ground
5	Composite video 4 / S-Video : Luma in (selected by JP2)
6	Ground

LED1 – Controller status LED connector: 3-pin header

PIN	DESCRIPTION
1	Green LED pin (anode)
2	LED pin common (cathode)
3	Red LED pin (anode)

IR1 – Infra-Red sensor connector: JST B3B-XH-A (Matching type : XHP-3)

PIN	SYMBOL	DESCRIPTION
1	GND	Ground
2	STDBY_Vcc	Stand by voltage
3	IR Data	IR data

PP2/PP3 – Alternate 12/24VDC power supply

PIN	DESCRIPTION
1	+12VDC 5A max / +24VDC 5A max
2	Ground

PP4 - Power supply

PIN	DESCRIPTION
1	+12VDC 5A max / +24VDC 5A max
2	Ground

CONTROLLER DIMENSIONS

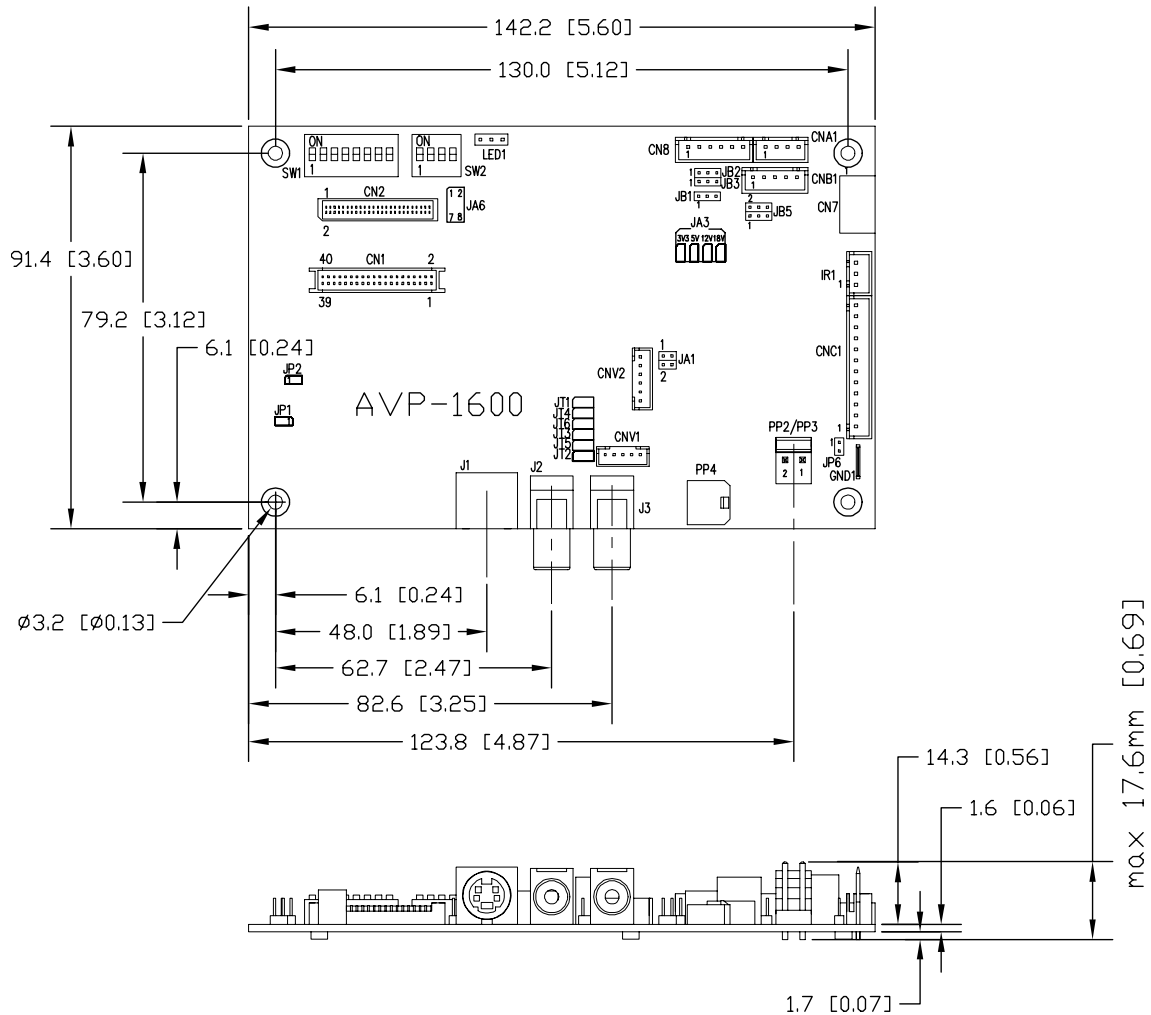

The maximum thickness of the controller is 17.6mm (measured from bottom of PCB to top of components, including any underside components & leads). We recommend clearances of:

- 5mm from bottom of PCB - if mounting on a metal plate we also recommend a layer of suitable insulation material is added to the mounting plate surface.
- 10mm above the components
- 3~5mm around the edges

Any of the holes shown above can be used for mounting the PCB, they are 3.2mm in diameter.

CAUTION: Ensure adequate insulation is provided for all areas of the PCB with special attention to high voltage parts such as the inverter.

APPLICATION NOTES

USING THE CONTROLLER WITHOUT BUTTONS ATTACHED

This is very straightforward by following the steps below :

- Firstly setup the controller/display system with the buttons. With controls attached and display system active make any settings for color and image position as required then switch everything off.
- Use a jumper to close JP6 jumper, this will fix the board On.
- Refer to inverter specifications for details as to fixing brightness to a desired level, this may require a resistor, an open circuit or closed circuit depending on inverter.

INVERTER CONNECTION

There are potentially 3 issues to consider with inverter connection:

- Power
- Enable
- Brightness

Please read the following sections for a guide to these issues.

Inverter Power: As per the table for CNB1 pin 1 is ground and pin 2 provides 12V/ 24V DC. This should be matched with the inverter specification: see table.

CNB1	
PIN	DESCRIPTION
1	Ground
2	+12VDC / 24VDC

Remark: For higher power inverter, more current (for 12V / 24V) can be taken from CNA1 pin 1. Maximum current drawn on CNA1 pin 1 and CNB1 pin 2 is 3A (24V) / 3A(12V)

Enable: This is a pin provided on some inverters for On/Off function and is used by this panel controller for VESA DPMS compliance. If the inverter does not have an enable pin or the enable pin is not used then DPMS will not be operational. Pin 3 should be matched to the inverters specification for the 'enable' or 'disable' pin.

CNB1	
PIN	DESCRIPTION
3	Enable

Further, jumpers JB2 & JB3 should be set to match the inverters specification for the enable pin power and High or Low setting: see table.

Ref	Purpose	Note
JB2	Inverter enable voltage	1-2 H = 12V/24V, 2-3 H = 5V (Vcc), OPEN H = open collector
JB3	Inverter control	1-2 H = On, 2-3 L = On

Brightness: There are various methods for brightness control and it is important to consider the specifications for the inverter to be used. Generally the situation is:

- Brightness can control by using a resistor or VR (Variable Resistor).
- Brightness controlled by adding a circuit such as PWM (Pulse Width Modulation).
- No adjustment of brightness is possible.

CNB1 pins 4 & 5 are available for connecting to an inverter or circuit where VR control is supported.

CNB1	
PIN	DESCRIPTION
4	VR WIP
5	VR A

This can then be matched with function controls (OSD switch mount) pins 3 & 4: see cable design below .

Specifications subject to change without notice

© Digital View Ltd – Doc Ver 1.2: 3 Dec, 2010 (AVP-1600_manual.doc)

Page 20 of 35

Design Guideline for making VR circuitry :

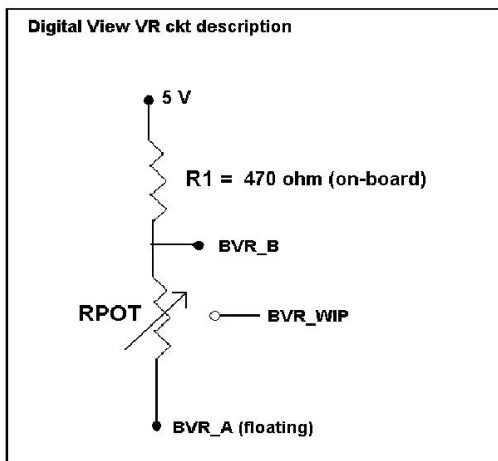

Signal description / Notes :

- 1) R1 : 470ohm on board
- 2) RPOT is an external potentiometer (in-line dip style) that can be plugged directly into CNC1 pins 3,4,5. RPOT must be supplied / installed by user.
- 3) BVR_B : Voltage tapped from "top" of potentiometer, the node of R1 and RPOT.
- 4) BVR_WIP : Voltage tapped from wiper arm of RPOT.
- 5) BVR_A : Voltage tapped from "bottom" of RPOT.

Note : BVR_A voltage is left floating on the controller board. To use this circuit, you need to tie this point to a potential (usually GND, available at CNC1 pin 6).

CNB1 – Backlight inverter connector: JST B5B-XH-A (Matching type : XHP-5)

PIN	SYMBOL	DESCRIPTION
1	GND	Ground
2	VBKL	+12VDC / 24VDC, backlight power supply (selected by JA3 & JA6)
3	BLCTRL	On/Off control (enable) – see JB2 & JB3
4	BVR_WIP	Brightness VR - WIP
5	BVR_A	Brightness VR A

CNC1 – Control switch, JST B12B-XH-A (Matching type : XHP-12)

PIN	SYMBOL	DESCRIPTION
1	PSWIN	Power button A
2	SW_ON	Power button B
3	BVR_A	Backlight Brightness VR pin A
4	BVR_WIP	Backlight Brightness R pin WIP
5	BVR_B	Backlight Brightness VR pin B (470 ohm resistor to +5V Vcc)
6	GND	Ground
7	MENU	OSD menu
8	-/LEFT	OSD -/Left
9	+ /RIGHT	OSD +/Right
10	SEL_DN	OSD Select down
11	SEL_UP	OSD Select up
12	NC	No connection

The VR for brightness depends on the inverter. The main power load for On/Off is handled by a relay on the controller.

Example for circuit design :

- 1.) Choose RPOT = 10K
- 2.) Tie BVR_A to GND
- 3.) Circuit analysis gives BVR_WIP as the following (see Figure 1)

$$BVR_WIP = 5 \times (R_{bc}/10.47)$$

where BVR_WIP is in Volts.
And Rbc is the resistance from the wiper arm to bottom of pot in Kohms.

To evaluate, plug in different values of Rbc :

Rbc	BVR_WIP
0	0 V
2.5 K	1.2 V
5 K	2.4 V
7.5 K	3.6 V
10 K	4.8 V

So this circuit could provide Brightness adjust voltage ranging from 0V to 5V.

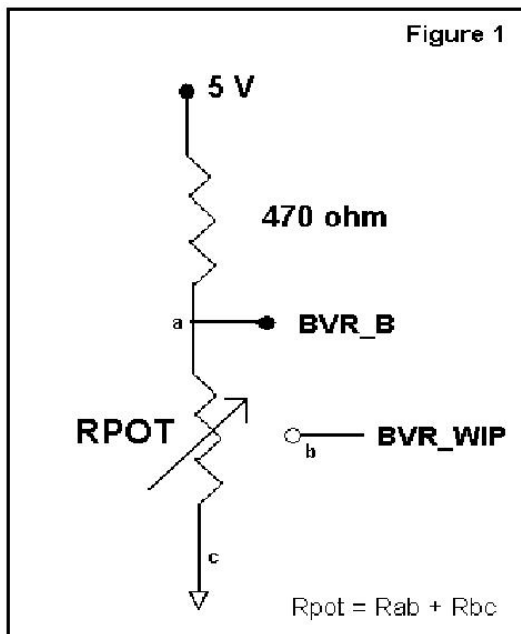

Specifications subject to change without notice

TROUBLESHOOTING

General

A general guide to troubleshooting a flat panel display system it is worth considering the system as separate elements, such as:

- Controller (jumpers)
- Panel
- Backlight (inverter, cabling, backlight tubes)
- Cabling
- Video Source

Through step by step cross checking with instruction manuals and a process of elimination to isolate the problem it is usually possible to clearly identify the problem area.

No image:

- If the panel backlight is not working it may still be possible to just see some image on the display.
- A lack of image is most likely to be caused by incorrect connection, lack of power, failure to provide a signal.

Image appearance:

- A faulty panel can have blank lines, failed sections, flickering or flashing display
- Incorrect jumper settings on the controller may cause everything from total failure to incorrect image. CAUTION: Do not set the panel power input incorrectly.
- Sparkling on the display: faulty panel signal cable.

Backlight:

Items to check include: Power input, Controls, Inverter and Tubes generally in this order.

If half the screen is dimmer than the other half:

- Check cabling for the inverter.
- For a specific backlight tube check the AC pins orientation (CAUTION: Never reverse any DC power pins).

Also:

- If adjusting brightness control has no effect the chances are that the VR rating or method of adjusting brightness is not compatible or correctly connected to the inverter.
- If system does not power down when there is a loss of signal

Continued failure:

If unit after unit keeps failing consider and investigate whether you are short circuiting the equipment or doing something else seriously wrong.

Generally after common sense issues have been resolved we recommend step by step substitution of known working parts to isolate the problem.

SPECIFICATIONS

Panel compatibility	1600x1200, 1400x1050, 1366x768, 1280x1024, 1280x800, 1280x768, 1024x768, 800x600, 800x480, 640x480 TFT LVDS or TTL single pixel LCD's support.
No. of colors	Up to 3 x 8 bit providing 16.7 million colors.
Video formats	PAL, PAL M, NTSC, NTSC 4.43 & SECAM
Controls available	- On/Off - Brightness (inverter) - OSD menu, - OSD select - OSD setting + - OSD setting -
Control interface	- Buttons, RS-232, IR remote control
Settings memory	Settings are stored in non volatile memory
Language OSD support	Graphics OSD icons
Plug & Play	VESA DDC 1, 2/b compatible
Voltage output for LCD	+3.3V , +5V, +12V, +18V The current drawn for 18V panel from 24VDC power input is limited to 2A. The current drawn for 3.3V, 5V or 12V panel from 12V/24VDC power input is limited to 3A.
Input voltage	12VDC , 5A max / 24VDC 5A max +/- 5%
Controller power consumption	Approx 4W (controller logic only, no panel and inverter are involved)
Controller dimensions	142mm x 92mm x 17.6mm
Storage temperature limits	-40°C to +70°C
Operating temperature limits	0°C to +60°C

NOTES

Please note the following:

- For specific panel setup a sample of an LCD may be required (this will be returned) and a copy of the full technical specifications for the panel from the manufacturer.
- Layout and custom development services are available.

Appendix I – Video Mode Support Table

COMPOSITE, S-VIDEO INPUT PORT :

System	Resolution	Horizontal freq [KHz]	Vertical freq [Hz]
NTSC	720x480	15.7	60
NTSC 4.43	720x480	15.7	60
PAL	720x576	15.6	50
PAL M	720x576	15.6	60
SECAM	720x576	15.6	50

Appendix II – RS-232 control protocols

RS-232 Serial control (Baud rate 2400, 8 bits, 1 stop bit and no parity)

Physical connection :

Controller side

Connector interface : CN8

Mating connector : JST XHP-6

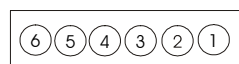

Mating face of CN8

Computer side

Connector interface : Serial port

Mating connector : DB9 Female



Mating face of RS-232 DB9 Male

PIN#	Description
4	RS-232 Tx Data
5	Ground
6	RS-232 Rx Data

PIN#	Description
2	RS-232 Rx Data
3	RS-232 Tx Data
5	Ground

Remark :

(1) : RS-232 connection cable, 600mm P/N 4260902-00 can be ordered separately for connection.

Software connection :

The OSD function can be controlled through sending the RS-232 protocol.

The RS-232 program can be custom-made to fit for application or it can be used the program provided by DigitalView on request. Please contact your local sales for informations.

1. Commands to implement switch mount control buttons

Function	Command	Description	Acknowledge (if enabled)
OSD Lock	0xf6	OSD Lock Off / OSD Lock On	Button equivalent
Menu	0xf7	Menu button pressed	Button equivalent
Select-down button	0xfa	Select down button pressed	Button equivalent
Select-up button	0xfb	Select up button pressed	Button equivalent
Right/+ button	0xfc	Right/+button pressed	Button equivalent
Left/- button	0xfd	Left/- button pressed	Button equivalent

2. Parameter setting - immediate, relative, reset and query

Function	Command	Description	Acknowledge (if enabled)
Volume control - left + right channel	0x80, "a" "A", nn "+" "-" "r" "R" "?"	Set audio (L+R) volume = value/increment/decrement Reset Query	Volume left + right
Volume control - on/off (mute)	0x80, "m" "M", "0" "1" "r" "R" "?"	Disable audio output Enable audio output Reset Query	"0" – audio off (muted) "1" – audio on
Brightness control	0x81, nn "+" "-" "r" "R" "?"	Set brightness = value/increment/decrement Reset Query	Brightness. Range: "0"0"- "F"FF Default: "8"0
Contrast control	0x82, "a" "A", nn "+" "-" "r" "R" "?"	Set all contrast = value/increment/decrement Reset Query	Contrast. Range: "4"0"- "F"FF Default: "8"0

Specifications subject to change without notice

Saturation	0x83, nn "+" "-" "r" "R" "?"	Set saturation= value/increment/decrement Reset Query	Saturation (In video mode only) Range: "0"0"-7"FF Default: "4"0
Hue	0x84, nn "+" "-" "r" "R" "?"	Set hue= value/increment/decrement Reset Query	Hue (In video mode only) Range: "0"0"-F"FF Default: "8"0
Sharpness	0x8a, nn "+" "-" "r" "R" "?"	Set sharpness= value/increment/decrement Reset Query	Sharpness Range: "0"0"-3"0 Default: "0"6
OSD H position	0x90, nnn "+" "-" "r" "R" "?"	Set osd_hpos = value/increment/decrement Reset Query	OSD horizontal position Range: "0"0"0"-3"E"8 Default: "1"FF"4
OSD V position	0x91, nnn "+" "-" "r" "R" "?"	Set osd_vpos = value/increment/decrement Reset Query	OSD vertical position Range: "0"0"0"-3"E"8 Default: "1"FF"4
Select menu timeout	0x93, nn "+" "-" "r" "R" "?"	Select menu timeout = value/increment/decrement Reset Query	OSD menu timeout value. "00" – Continuous. Value – Round up to nearest available step. If value > max available step, set it to the max available step. Range: "0"0"-3"C" Default: "0"A
Input main select * Function in Valid mode only	0x98, nn "+" "-" "r" "R" "?"	Select input main = PC or video or next available Reset Query	Main selected. "0" – S-video. "1" – Composite video 1. "2" – S-video 2. "3" – Composite video 2. "0" – Composite video 1. "1" – Composite video 2. "2" – Composite video 3. "3" – Composite video 4. "0x42,0x31" Composite 1 "0x42,0x32" Composite 2 "0x42,0x33" Composite 3 "0x42,0x34" Composite 4 "0x43,0x31" S-video 1 "0x43,0x32" S-video 2
Video System	0x9b, "0" "1" "2" "3" "4" "r" "R" "?"	Set video system = Auto/NTSC/PAL/SECAM Reset Query	Video State Query: "0" – Auto. (Default) "1" – PAL "2" – PAL_M "3" – NTSC "4" – NTSC_443 "5" – SECAM
GAMMA value select	0x9d, n "r" "R" "?"	Select GAMMA value = Value Reset Query	GAMMA value: "0" – 0.4, "1" – 0.6 "2" – 1.0 (Default), "3" – 1.6 "4" – 2.2
Color temperature select	0xb3, n	Select color temperature = value	Main selected. "0" – user defined RGB values.

Specifications subject to change without notice

	"r" "R" "?"	Reset Query	"1" – 4200K. "2" – 5000K. "3" – 6500K. "4" – 7500K. (Default) "5" – 9300K.
Red level for selected color temperature	0xb4, nn "+" "-" "r" "R" "?"	Set the level of the red channel for the selected color temp. = value/increment/decrement Reset Query	Red level for selected color temperature. Range: "8"0"- "F"FF" Default: "F"FF"
Green level for selected color temperature	0xb5, nn "+" "-" "r" "R" "?"	Set the level of the green channel for the selected color temp. = value/increment/decrement Reset Query	Green level for selected color temperature. Range: "8"0"- "F"FF" Default: "F"FF"
Blue level for selected color temperature	0xb6, nn "+" "-" "r" "R" "?"	Set the level of the blue channel for the selected color temp. = value/increment/decrement Reset Query	Blue level for selected color temperature. Range: "8"0"- "F"FF" Default: "F"FF"
Backlight brightness control	0xe0, nn "+" "-" "r" "R" "?"	Set backlight brightness = value/increment/decrement Reset Query	Backlight brightness. Range: "0"0"- "F"FF" Default: "F"FF" e.g. "1"0" → 0xe0 0x31 0x30 * This control can only function when JB5 sets 3-4 closed * Apply for inverter control voltage in range of 0~5V. Each step interval is in 1
Backlight on/off control	0xe1, "0" "1" "r" "R" "?" "s" "S"	Set backlight brightness = Disable backlight Enable backlight Reset Query Backlight working status	Backlight on/off. "1" = normal (Default)
OSD Lock	0xf6, n "0" "1" "r" "R" "?"	OSD Lock Off/ OSD Lock On Reset Query	"0" – OSD Lock Off "1" – OSD Lock On

3. Other control

Function	Command	Description	Acknowledge (if enabled)
Select RS-232 acknowledge	0xc1, "0" "1"	Disable/enable command acknowledge.	"0" – acknowledge disabled. "1" – acknowledge enabled.
Command availability	0xc4, nn	Check whether a command is available.	"0" – not available. "1" – available.
Query BIOS version	0xcb, "0"	Read BIOS version	"nnnn" = BIOS ver. "nn.nn"
Query PCBA number	0xcb, "1"	Read PCBA number	"nnnn" = PCBA number AVP-1600="41722"
Load factory defaults	0xce	Reset all parameters to default value	"1" – successful.

Specifications subject to change without notice

Hex to ASCII conversion table

Hex	ASCII	Hex	ASCII	Hex	ASCII	Hex	ASCII
0x30	0	0x41	A	0x61	a	0x2B	+
0x31	1	0x42	B	0x62	b	0x2D	-
0x32	2	0x43	C	0x63	c	0x3F	?
0x33	3	0x44	D	0x64	d		
0x34	4	0x45	E	0x65	e		
0x35	5	0x46	F	0x66	f		
0x36	6	0x47	G	0x67	g		
0x37	7	0x48	H	0x68	h		
0x38	8	0x49	I	0x69	i		
0x39	9	0x4A	J	0x6A	j		
		0x4B	K	0x6B	k		
		0x4C	L	0x6C	l		
		0x4D	M	0x6D	m		
		0x4E	N	0x6E	n		
		0x4F	O	0x6F	o		
		0x50	P	0x70	p		
		0x51	Q	0x71	q		
		0x52	R	0x72	r		
		0x53	S	0x73	s		
		0x54	T	0x74	t		
		0x55	U	0x75	u		
		0x56	V	0x76	v		
		0x57	W	0x77	w		
		0x58	X	0x78	x		
		0x59	Y	0x79	y		
		0x5A	Z	0x7A	z		

Appendix III – Mapping definition

- Definition of Mapping A :

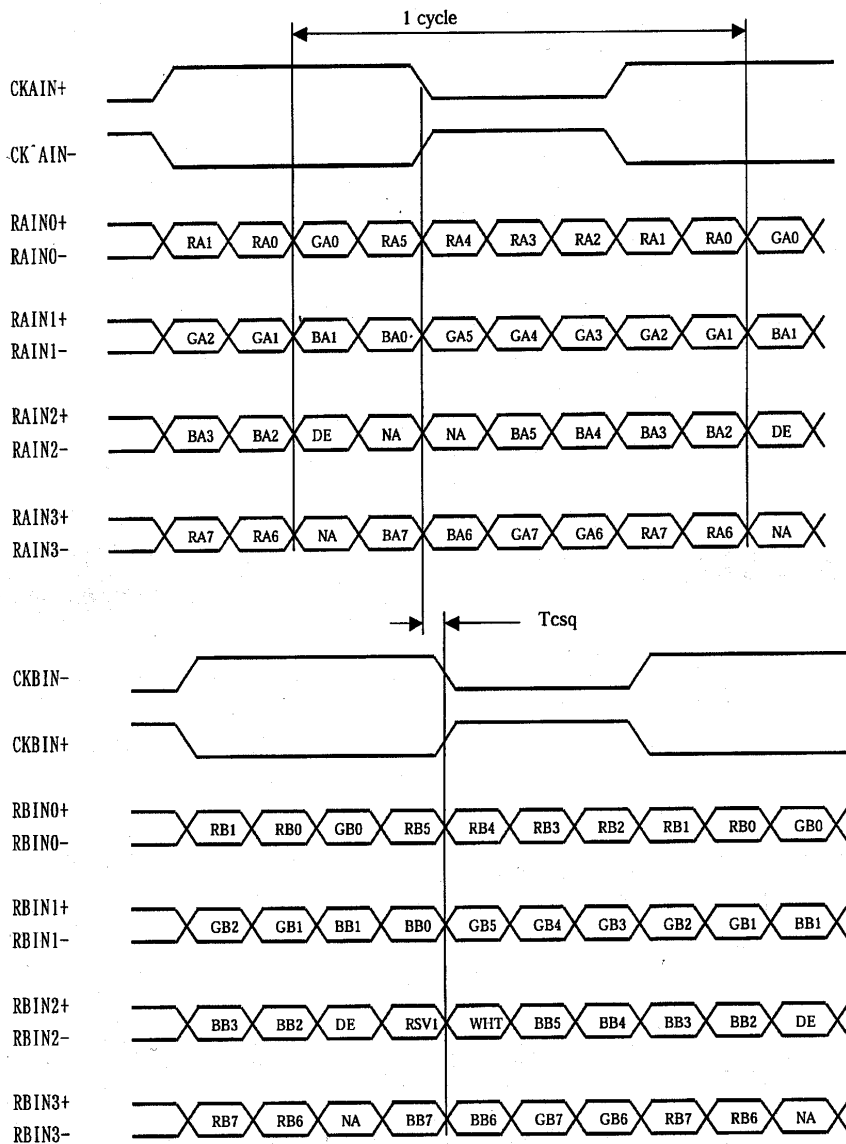

- Definition of Mapping B :

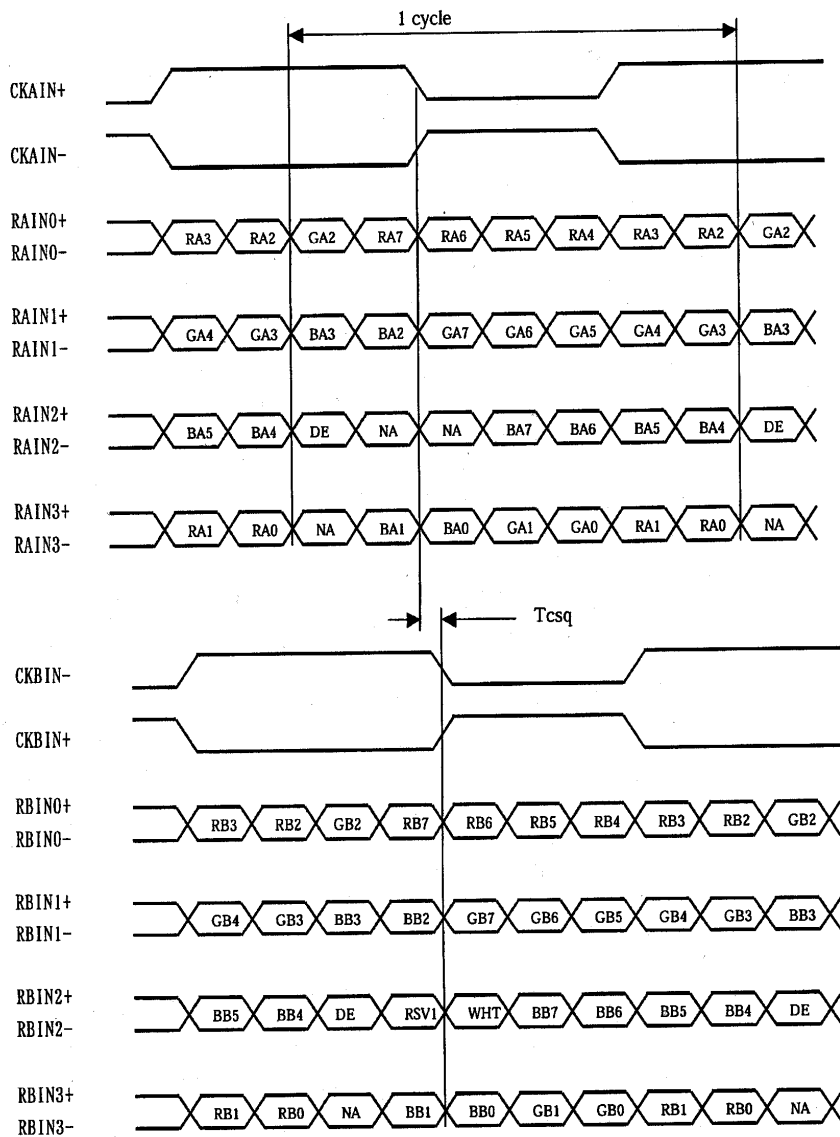





Appendix V – DV remote control unit work for AVP-1600

P/N 559000106-3 :
DigitalView remote control unit
(without DV logo silk screen
printing)

P/N 559000105-3 :
DigitalView remote control unit
(with DigitalView logo silk
screen printing)



BUTTON	FUNCTION
ATTENTION BUTTON*	Use combined with digit keys to enable/disable the IR function.
POWER BUTTON	AVP-1600 : "Attention" + "1" Soft power ON/OFF button.
MUTE BUTTON ()	Switch to mute on/off mode. Mute icon () displays on screen when mute on mode.
SEL UP () / SEL DN ()	In OSD menu, pressing this button to select the items.
VOLUME (-/+) BUTTON	Press the "+" button to increase the volume and the "-" to decrease the volume.
+ / - BUTTON	Press the "+" button to switch to the next input source under OSD menu off state. In OSD menu, pressing this button to adjust the settings.
DISPLAY BUTTON	Use to view an on-screen information. When OSD menu displayed, press this button to turn it off.
S-Video BUTTON	In input source selection mode, pressing this button to select S-Video 1 source.
Composite 1 BUTTON	In input source selection mode, pressing this button to select Composite 1 source.

* Support in V1.03.00 or up firmware version or up only.

Appendix VI – Audio Add-on Board P/N 416940020-3

[OPERATE UNDER 12VDC POWER INPUT ENVIRONMENT]

The Audio add-on board P/N 416940020-3 design for connection with DV controllers on the audio connector CN7. It provides audio input ports and output port for sound amplification.

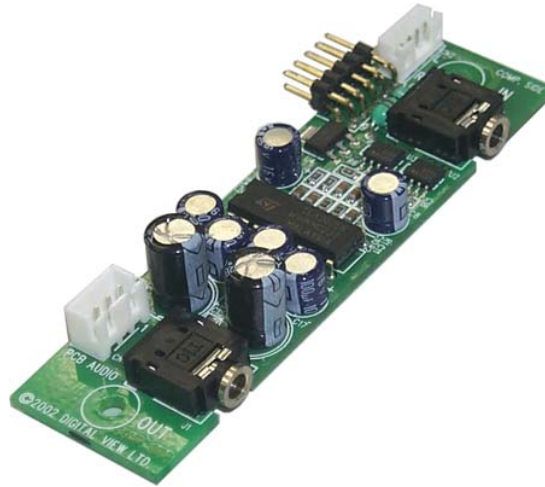

Electrical Specification :

Supply Voltage : +12V, +5V

Supply current : 35mA for +12V, 6mA for +5V

Input impedance 6.8kohm

Output power : 2.0W for 4ohm load

1.0W for 8ohm load

Distortion : <2%

Voltage gain : 0 to 21 dB

Use of connectors :

Connector	Connector type
CN1	JST B3B-XH-A
CN2	JST B4B-PH-K
CN3	0.1 inches 2 row x 5 pin header strips (right angle)
J1	Ø3.5mm stereo jack socket
J2	Ø3.5mm stereo jack socket

Pin Assignments :

CN1: Output alternate connector

Pin Number	Description
1	Speaker out left
2	Ground
3	Speaker out right

CN2: Input alternate connector

Pin Number	Description
1	Ground
2	Audio input left
3	Ground
4	Audio input right

CN3 : Controller interface connector

Pin Number	Description
1	+5V
2	Left trimpot chip select
3	Right trimpot chip select
4	Trimpot serial data
5	Trimpot serial clock
6	Digital Ground
7	+12V
8	Audio input left
9	Audio input right
10	Audio Ground

Mechanical Drawing :

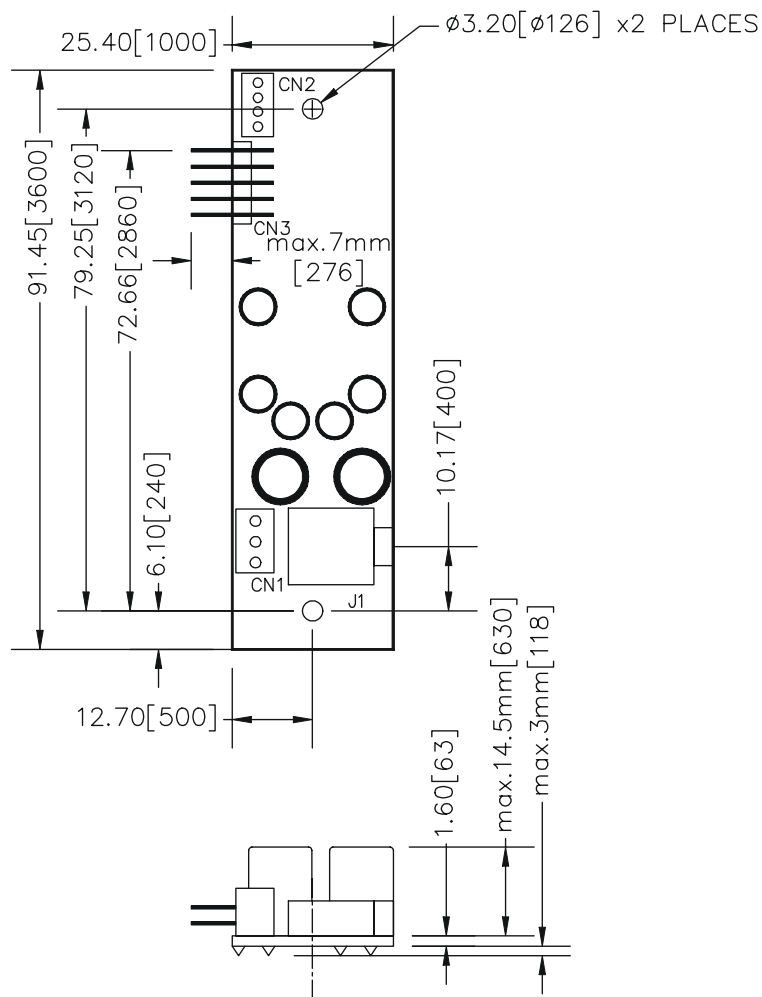

Specifications subject to change without notice

WARRANTY

The products are warranted against defects in workmanship and material for a period of three (3) year from the date of purchase provided no modifications are made to it and it is operated under normal conditions and in compliance with the instruction manual.

The warranty does not apply to:

- Product that has been installed incorrectly, this specifically includes but is not limited to cases where electrical short circuit is caused.
- Product that has been altered or repaired except by the manufacturer (or with the manufacturer's consent).
- Product that has subjected to misuse, accidents, abuse, negligence or unusual stress whether physical or electrical.
- Ordinary wear and tear.

Except for the above express warranties, the manufacturer disclaims all warranties on products furnished hereunder, including all implied warranties of merchantability and fitness for a particular application or purpose. The stated express warranties are in lieu of all obligations or liabilities on the part of the manufacturer for damages, including but not limited to special, indirect consequential damages arising out of or in connection with the use of or performance of the products.

CAUTION

Whilst care has been taken to provide as much detail as possible for use of this product it cannot be relied upon as an exhaustive source of information. This product is for use by suitably qualified persons who understand the nature of the work they are doing and are able to take suitable precautions and design and produce a product that is safe and meets regulatory requirements.

LIMITATION OF LIABILITY

The manufacturer's liability for damages to customer or others resulting from the use of any product supplied hereunder shall in no event exceed the purchase price of said product.

TRADEMARKS

The following are trademarks of Digital View Ltd:

- Digital View
- AVP-1600

CONTACT DETAILS

Digital View has offices in Asia, Europe and USA also an internet site:

USA

Digital View Inc.
18440 Technology Drive
Building 130
Morgan Hill,
California, 95037
USA

Tel: (1) 408-782 7773 **Fax:** (1) 408-782 7883

Sales: ussales@digitalview.com

EUROPE

Digital View Ltd.
6 Marylebone Passage,
London, W1W 8EX
UK

Tel: +44-(0)20-7631-2150 **Fax:** +44-(0)20-7631-2156

Sales: uksales@digitalview.com

ASIA

Digital View Ltd
16th Floor Millennium City 3
370 Kwun Tong Road
Kwun Tong
Hong Kong

Tel: (852) 2861 3615 **Fax:** (852) 2520 2987

Sales: hksales@digitalview.com

WEBSITE

www.digitalview.com