

### FEATURES

- Operation from 700 MHz to 1000 MHz
- Gain of 23 dB at 943 MHz
- OIP3 of 44.2 dBm at 943 MHz
- P1dB of 30.9 dBm at 943 MHz
- Noise figure of 4.8 dB at 943 MHz
- Power supply: 5 V
- Power supply current: 307 mA typical
- Internal active biasing
- Fast power-up/power-down function
- Compact 4 mm × 4 mm, 16-lead LFCSP
- ESD rating of ±1 kV (Class 1C)
- Pin-compatible with the [ADL5606](#) (1800 MHz to 2700 MHz)

### APPLICATIONS

- Wireless infrastructure
- Automated test equipment
- ISM/AMR applications

### GENERAL DESCRIPTION

The [ADL5605](#) is a broadband, two-stage, 1 W RF driver amplifier that operates over a frequency range of 700 MHz to 1000 MHz.

The [ADL5605](#) operates on a 5 V supply voltage and a supply current of 307 mA. The driver also incorporates a fast power-up/power-down function for TDD applications, applications that require a power saving mode, and applications that intermittently transmit data.

The [ADL5605](#) is fabricated on a GaAs HBT process and is packaged in a compact 4 mm × 4 mm, 16-lead LFCSP that uses an exposed paddle for excellent thermal impedance. The [ADL5605](#) operates from -40°C to +85°C. A fully populated evaluation board tuned to 943 MHz is also available.

### FUNCTIONAL BLOCK DIAGRAM

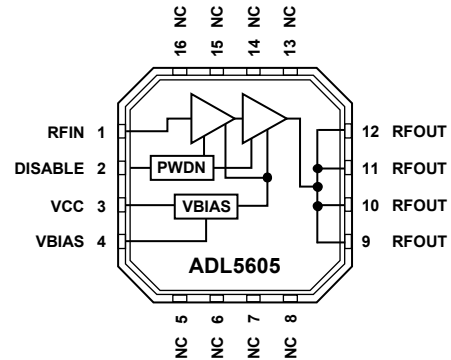

Figure 1.

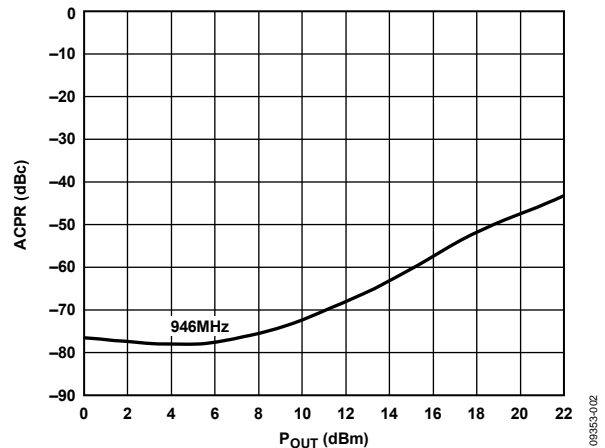

Figure 2. ACPR vs. Output Power, 3GPP, TM1-64, at 946 MHz

### Rev. 0

Information furnished by Analog Devices is believed to be accurate and reliable. However, no responsibility is assumed by Analog Devices for its use, nor for any infringements of patents or other rights of third parties that may result from its use. Specifications subject to change without notice. No license is granted by implication or otherwise under any patent or patent rights of Analog Devices. Trademarks and registered trademarks are the property of their respective owners.

## TABLE OF CONTENTS

Features .....	1	943 MHz Frequency Tuning Band.....	10
Applications.....	1	General.....	11
General Description .....	1	Applications Information .....	13
Functional Block Diagram .....	1	Basic Layout Connections.....	13
Revision History .....	2	ADL5605 Matching.....	14
Specifications.....	3	ACPR and EVM .....	15
Typical Scattering Parameters.....	5	Thermal Considerations.....	15
Absolute Maximum Ratings.....	6	Soldering Information and Recommended PCB Land Pattern.....	15
Thermal Resistance .....	6	Evaluation Board .....	16
ESD Caution.....	6	Outline Dimensions .....	18
Pin Configuration and Function Descriptions.....	7	Ordering Guide .....	18
Typical Performance Characteristics .....	8		
748 MHz Frequency Tuning Band.....	8		
881 MHz Frequency Tuning Band.....	9		

## REVISION HISTORY

7/11—Revision 0: Initial Version

## SPECIFICATIONS

VCC1 = 5 V and T<sub>A</sub> = 25°C, unless otherwise noted.<sup>1</sup>

Table 1.

Parameter	Test Conditions/Comments	Min	Typ	Max	Unit
OVERALL FUNCTION					
Frequency Range		700		1000	MHz
FREQUENCY = 748 MHz ± 20 MHz					
Gain			24.3		dB
vs. Frequency	±20 MHz		+0.01/−0.19		dB
vs. Temperature	−40°C ≤ T <sub>A</sub> ≤ +85°C		±0.8		dB
vs. Supply	4.75 V to 5.25 V		±0.07		dB
Output 1 dB Compression Point (P1dB)			31.4		dBm
vs. Frequency	±20 MHz		−0.68/+0.08		dB
vs. Temperature	−40°C ≤ T <sub>A</sub> ≤ +85°C		+0.94/−1.99		dB
vs. Supply	4.75 V to 5.25 V		−0.24/−0.05		dB
Output Third-Order Intercept (OIP3)	Δf = 1 MHz, P <sub>OUT</sub> = 14 dBm per tone		41.9		dBm
vs. Frequency	±20 MHz		−0.22/+0.16		dB
vs. Temperature	−40°C ≤ T <sub>A</sub> ≤ +85°C		+0.07/−1.56		dB
vs. Supply	4.75 V to 5.25 V		+0.04/+0.09		dB
Noise Figure			4.8		dB
FREQUENCY = 881 MHz ± 13 MHz					
Gain			23.0		dB
vs. Frequency	±13 MHz		−0.03/−0.08		dB
vs. Temperature	−40°C ≤ T <sub>A</sub> ≤ +85°C		±0.7		dB
vs. Supply	4.75 V to 5.25 V		±0.05		dB
Output 1 dB Compression Point (P1dB)			31.4		dBm
vs. Frequency	±13 MHz		−0.18/−0.11		dB
vs. Temperature	−40°C ≤ T <sub>A</sub> ≤ +85°C		±0.6		dB
vs. Supply	4.75 V to 5.25 V		−0.4/+0.3		dB
Output Third-Order Intercept (OIP3)	Δf = 1 MHz, P <sub>OUT</sub> = 14 dBm per tone		43.4		dBm
vs. Frequency	±13 MHz		−0.32/+0.40		dB
vs. Temperature	−40°C ≤ T <sub>A</sub> ≤ +85°C		−0.19/−0.99		dB
vs. Supply	4.75 V to 5.25 V		+0.21/−0.03		dB
Noise Figure			4.7		dB
FREQUENCY = 943 MHz ± 18 MHz					
Gain			23.0		dB
vs. Frequency	±18 MHz		+0.28/−0.04		dB
vs. Temperature	−40°C ≤ T <sub>A</sub> ≤ +85°C		±0.8		dB
vs. Supply	4.75 V to 5.25 V		±0.04		dB
Output 1 dB Compression Point (P1dB)			30.9		dBm
vs. Frequency	±18 MHz		+0.39/−0.08		dB
vs. Temperature	−40°C ≤ T <sub>A</sub> ≤ +85°C		+0.7/−0.9		dB
vs. Supply	4.75 V to 5.25 V		−0.43/+0.35		dB
Adjacent Channel Power Ratio (ACPR)	P <sub>OUT</sub> = 18 dBm, one-carrier W-CDMA, 64 DPCH, frequency = 946 MHz		51		dBc
Output Third-Order Intercept (OIP3)	Δf = 1 MHz, P <sub>OUT</sub> = 14 dBm per tone		44.2		dBm
vs. Frequency	±18 MHz		−0.47/−0.10		dB
vs. Temperature	−40°C ≤ T <sub>A</sub> ≤ +85°C		+0.7/−1.6		dB
vs. Supply	4.75 V to 5.25 V		−0.08/+0.07		dB
Noise Figure			4.8		dB

# ADL5605

Parameter	Test Conditions/Comments	Min	Typ	Max	Unit
POWER-DOWN INTERFACE	DISABLE pin				
Logic Level to Enable	V <sub>DISABLE</sub> decreasing		0	1.1	V
Logic Level to Disable	V <sub>DISABLE</sub> increasing	1.4	5		V
DISABLE Pin Current	V <sub>DISABLE</sub> = 5 V		1.4		mA
VCC1 Pin Current <sup>1</sup>	V <sub>DISABLE</sub> = 5 V		5.5		mA
Enable Time	10% of control pulse to 90% of RFOUT		75		ns
Disable Time	10% of control pulse to 90% of RFOUT		20		ns
POWER INTERFACE	RFOUT pin				
Supply Voltage		4.75	5	5.25	V
Supply Current			307	385	mA
vs. Temperature	-40°C ≤ T <sub>A</sub> ≤ +85°C		-20/+1		mA

<sup>1</sup> VCC1 is the supply to the DUT through the RFOUT pins.

## TYPICAL SCATTERING PARAMETERS

VCC1 = 5 V and T<sub>A</sub> = 25°C; the effects of the test fixture have been de-embedded up to the pins of the device.<sup>1</sup>

Table 2.

Frequency (MHz)	S11		S21		S12		S22	
	Magnitude (dB)	Angle (°)	Magnitude (dB)	Angle (°)	Magnitude (dB)	Angle (°)	Magnitude (dB)	Angle (°)
100	-2.38	162.05	5.53	133.84	-48.08	12.48	-1.30	-147.53
150	-2.63	153.17	14.11	95.13	-47.50	2.17	-0.55	-172.43
200	-2.95	144.23	18.99	67.83	-55.96	-119.96	-0.68	-173.81
250	-3.50	135.13	22.75	39.76	-55.27	52.76	-1.24	-171.76
300	-4.41	127.84	25.46	-7.79	-61.09	77.07	-1.10	-176.42
350	-4.58	124.74	23.14	-63.51	-61.80	140.72	-1.06	-177.13
400	-5.11	110.20	17.94	-30.49	-52.49	171.89	-1.15	-176.29
450	-6.82	108.32	22.16	-61.71	-67.98	-27.39	-1.11	-177.02
500	-7.26	106.20	21.56	-87.12	-62.64	-21.99	-0.87	-177.37
550	-7.66	101.35	20.40	-105.19	-61.53	34.70	-0.92	-179.14
600	-8.25	95.77	19.42	-118.96	-61.21	99.93	-0.78	179.80
650	-8.86	89.58	18.55	-130.30	-61.13	129.82	-0.87	179.43
700	-9.58	82.66	17.89	-140.88	-59.03	107.89	-0.87	178.46
750	-10.59	75.33	17.40	-150.63	-61.26	91.70	-0.90	178.01
800	-11.75	66.62	17.07	-160.56	-57.17	92.00	-0.93	177.54
850	-13.27	57.13	16.89	-170.83	-56.35	107.58	-0.93	177.22
900	-15.44	46.13	16.84	178.03	-56.74	99.86	-0.96	176.90
950	-18.94	29.27	16.93	165.27	-54.82	107.20	-0.96	176.66
1000	-26.34	-2.06	16.96	150.36	-52.26	73.48	-0.98	176.43
1050	-26.92	-130.02	16.77	132.88	-54.70	68.96	-0.94	176.27
1100	-18.87	-171.63	16.17	113.62	-54.77	47.54	-0.81	176.15
1150	-15.30	163.88	14.89	94.11	-53.44	43.95	-0.76	175.49
1200	-13.83	145.18	13.13	76.86	-55.60	11.97	-0.72	174.79
1250	-13.51	129.85	11.09	62.33	-55.37	33.66	-0.66	173.83
1300	-13.68	117.81	8.95	50.66	-57.24	20.12	-0.68	173.19
1350	-14.26	108.51	6.91	41.54	-59.07	24.50	-0.66	172.57
1400	-14.96	99.61	4.91	33.49	-60.44	14.20	-0.69	171.85
1450	-15.76	92.58	3.04	26.87	-61.45	45.66	-0.63	171.46
1500	-16.83	86.52	1.23	21.09	-57.41	62.21	-0.69	170.87
1550	-17.90	79.79	-0.47	16.01	-62.00	53.37	-0.66	170.42
1600	-19.28	73.87	-2.09	11.40	-56.83	57.90	-0.69	169.98
1650	-20.56	67.65	-3.63	7.32	-57.60	58.62	-0.68	169.51
1700	-22.42	60.60	-5.10	3.62	-59.47	77.96	-0.68	168.99
1750	-24.45	51.72	-6.53	0.23	-58.70	76.85	-0.67	168.59
1800	-26.42	38.39	-7.92	-3.05	-55.11	66.53	-0.68	168.10
1850	-28.73	21.43	-9.27	-6.05	-58.19	37.40	-0.67	167.72
1900	-29.99	-4.11	-10.56	-8.66	-61.08	43.12	-0.68	167.18
1950	-29.61	-32.34	-11.84	-11.11	-57.28	78.91	-0.67	166.94
2000	-27.80	-55.73	-13.07	-13.38	-56.29	83.05	-0.68	166.45

<sup>1</sup> VCC1 is the supply to the DUT through the RFOUT pins.

## ABSOLUTE MAXIMUM RATINGS

Table 3.

Parameter	Rating
Supply Voltage, VCC1 <sup>1</sup>	6.5 V
Input Power (50 $\Omega$ Impedance)	20 dBm
Internal Power Dissipation (Paddle Soldered)	2 W
Maximum Junction Temperature	150°C
Lead Temperature (Soldering 60 sec)	240°C
Operating Temperature Range	-40°C to +85°C
Storage Temperature Range	-65°C to +150°C

<sup>1</sup> VCC1 is the supply to the DUT through the RFOUT pins.

Stresses above those listed under Absolute Maximum Ratings may cause permanent damage to the device. This is a stress rating only; functional operation of the device at these or any other conditions above those indicated in the operational section of this specification is not implied. Exposure to absolute maximum rating conditions for extended periods may affect device reliability.

## THERMAL RESISTANCE

Table 4 lists the junction-to-air thermal resistance ( $\theta_{JA}$ ) and the junction-to-paddle thermal resistance ( $\theta_{JC}$ ) for the [ADL5605](#). For more information, see the Thermal Considerations section.

Table 4. Thermal Resistance

Package Type	$\theta_{JA}$	$\theta_{JC}$	Unit
16-Lead LFCSP (CP-16-10)	52.1	12.1	°C/W

## ESD CAUTION



**ESD (electrostatic discharge) sensitive device.** Charged devices and circuit boards can discharge without detection. Although this product features patented or proprietary protection circuitry, damage may occur on devices subjected to high energy ESD. Therefore, proper ESD precautions should be taken to avoid performance degradation or loss of functionality.

## PIN CONFIGURATION AND FUNCTION DESCRIPTIONS

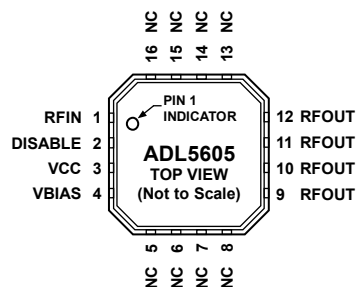

- NOTES**
1. THE EXPOSED PADDLE SHOULD BE SOLDERED TO A LOW IMPEDANCE ELECTRICAL AND THERMAL GROUND PLANE.
  2. NC = NO CONNECT. DO NOT CONNECT TO THIS PIN.

09353-003

Figure 3. Pin Configuration

Table 5. Pin Function Descriptions

Pin No.	Mnemonic	Description
1	RFIN	RF Input. Requires a dc blocking capacitor.
2	DISABLE	Connect this pin to 5 V to disable the part. In the disabled state, the part draws approximately 5 mA of current from the power supply and 1.4 mA from the DISABLE pin.
3	VCC	Under normal operation, this pin is connected to the power supply and draws a combined 307 mA of current. When this pin is grounded along with the VBIAS pin, the device is disabled and draws approximately 1.4 mA from the DISABLE pin.
4	VBIAS	Applying 5 V to this pin enables the bias circuit. When this pin is grounded, the device is disabled.
5, 6, 7, 8, 13, 14, 15, 16	NC	No Connect. Do not connect to this pin.
9, 10, 11, 12	RFOUT	RF Output. DC bias is provided to this pin through an inductor that is connected to the 5 V power supply. The RF path requires a dc blocking capacitor.
	EP	The exposed paddle should be soldered to a low impedance electrical and thermal ground plane.

## TYPICAL PERFORMANCE CHARACTERISTICS

### 748 MHz FREQUENCY TUNING BAND

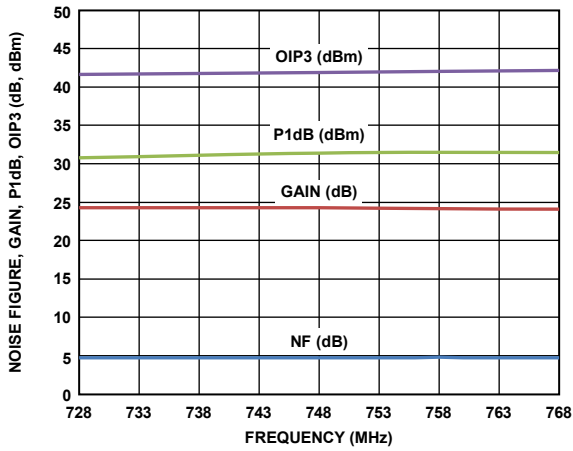

Figure 4. Noise Figure, Gain, P1dB, and OIP3 vs. Frequency (OIP3 at  $P_{OUT} = 14$  dBm per Tone)

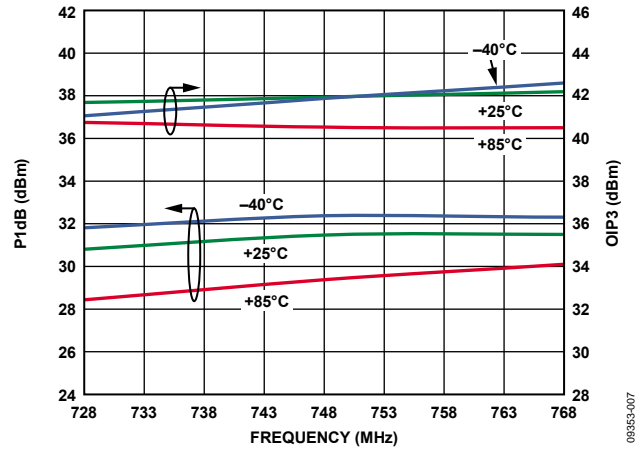

Figure 7. P1dB and OIP3 vs. Frequency and Temperature (OIP3 at  $P_{OUT} = 14$  dBm per Tone)

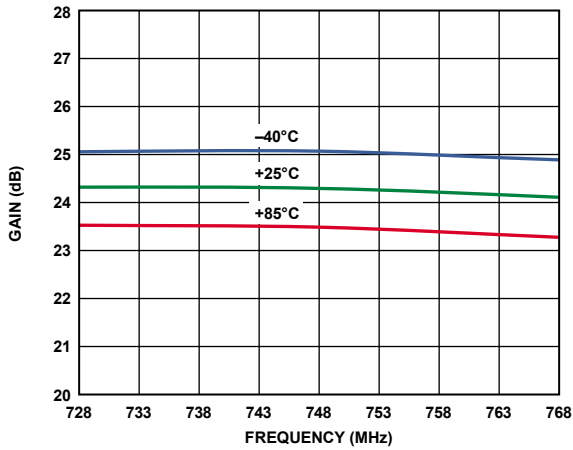

Figure 5. Gain vs. Frequency and Temperature

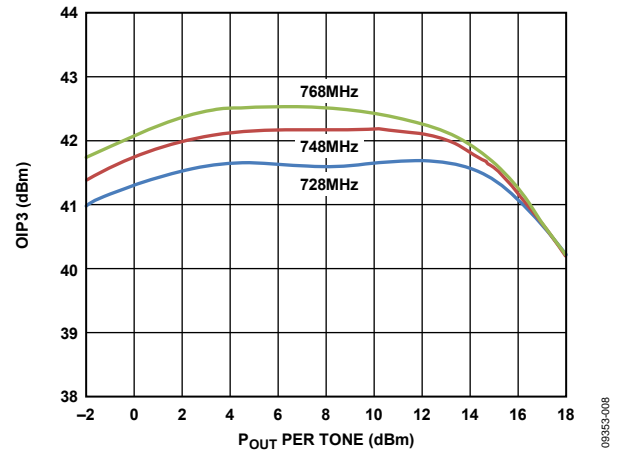

Figure 8. OIP3 vs.  $P_{OUT}$  and Frequency

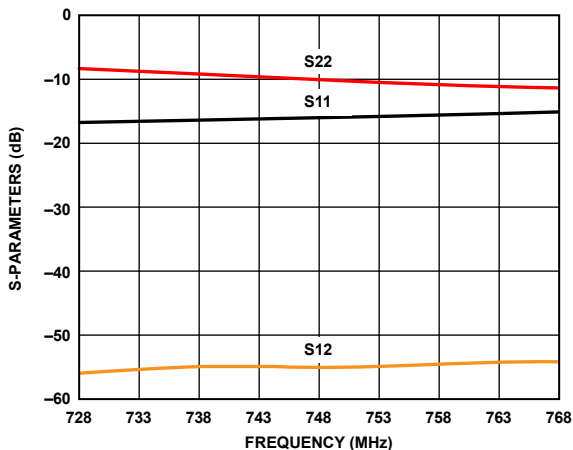

Figure 6. Input Return Loss (S11), Output Return Loss (S22), and Reverse Isolation (S12) vs. Frequency

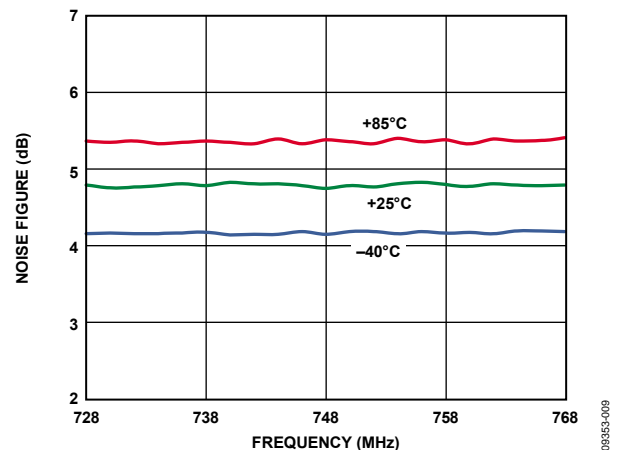

Figure 9. Noise Figure vs. Frequency and Temperature



881 MHZ FREQUENCY TUNING BAND

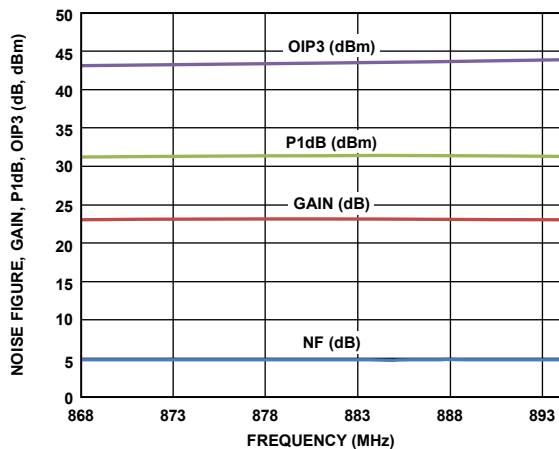

Figure 10. Noise Figure, Gain, P1dB, and OIP3 vs. Frequency (OIP3 at  $P_{OUT} = 14$  dBm per Tone)

09353-010

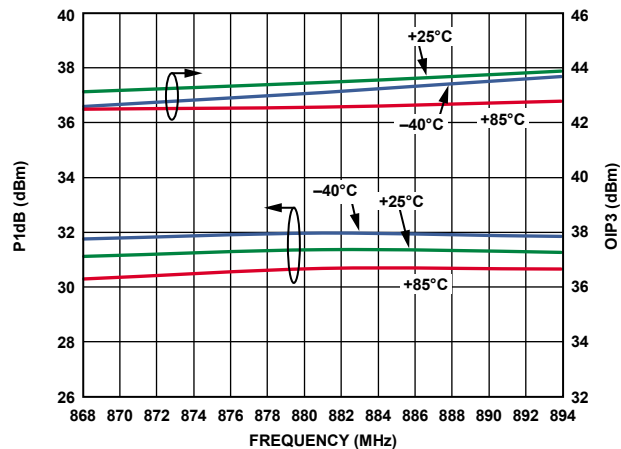

Figure 13. P1dB and OIP3 vs. Frequency and Temperature (OIP3 at  $P_{OUT} = 14$  dBm per Tone)

09353-013

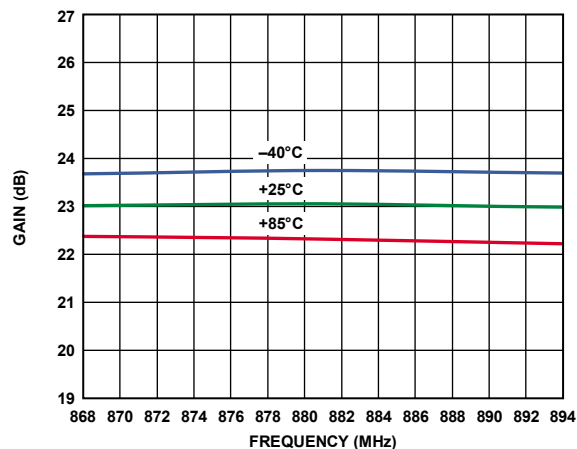

Figure 11. Gain vs. Frequency and Temperature

09353-011

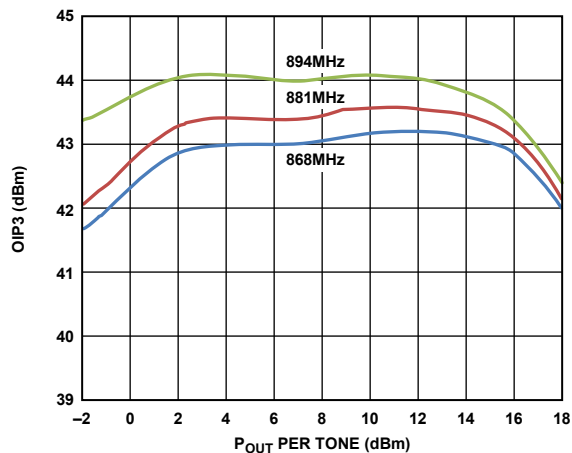

Figure 14. OIP3 vs.  $P_{OUT}$  and Frequency

09353-014

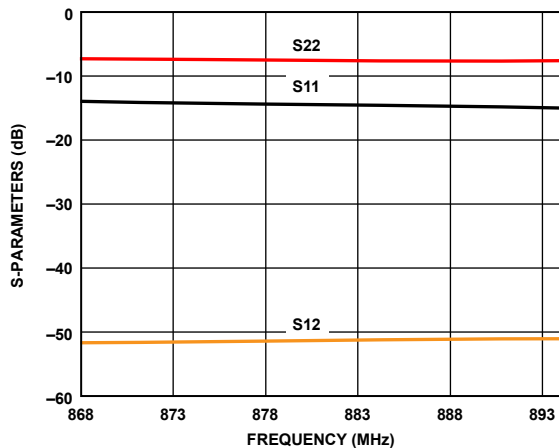

Figure 12. Input Return Loss (S11), Output Return Loss (S22), and Reverse Isolation (S12) vs. Frequency

09353-012

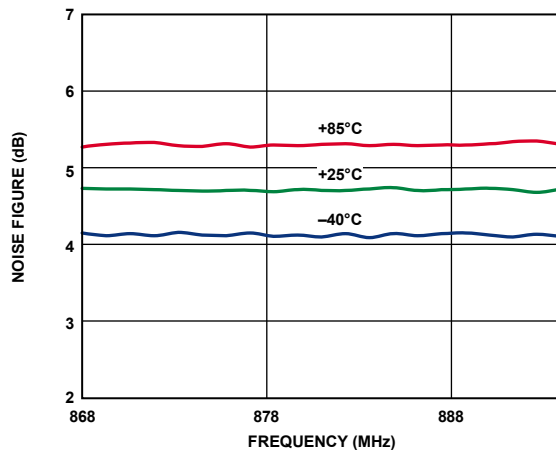

Figure 15. Noise Figure vs. Frequency and Temperature

09353-015

## 943 MHz FREQUENCY TUNING BAND

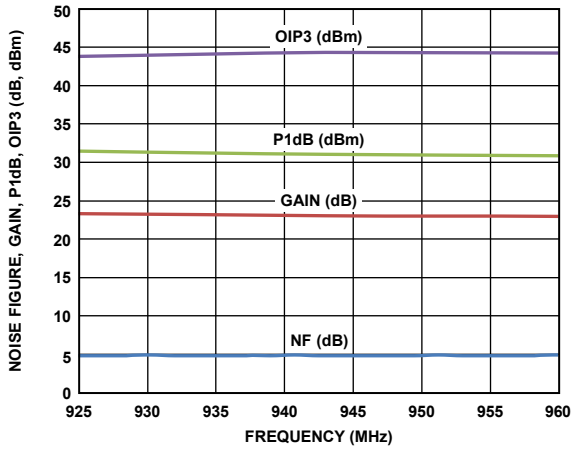

Figure 16. Noise Figure, Gain, P1dB, and OIP3 vs. Frequency (OIP3 at  $P_{OUT} = 14$  dBm per Tone)

09353-016

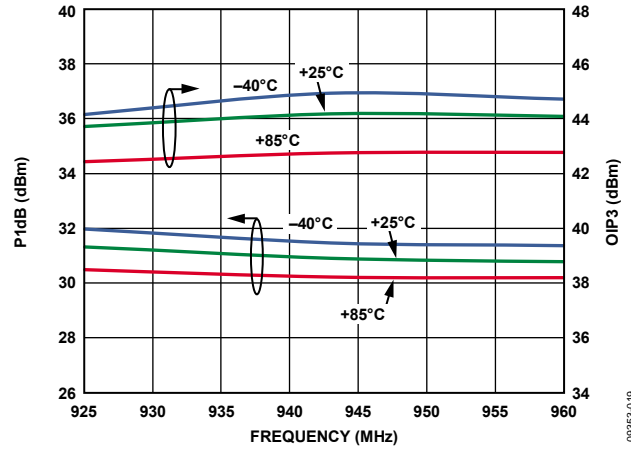

Figure 19. P1dB and OIP3 vs. Frequency and Temperature (OIP3 at  $P_{OUT} = 14$  dBm per Tone)

09353-019

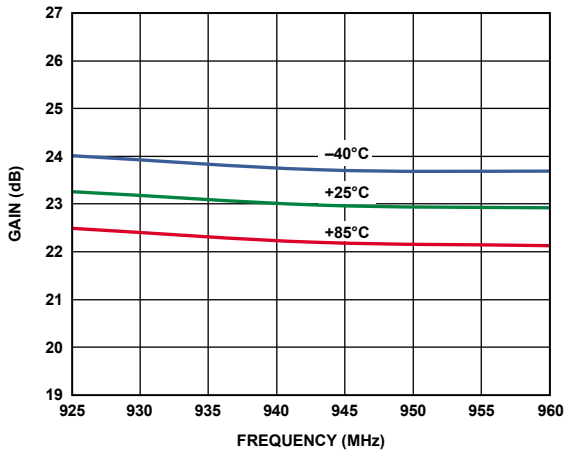

Figure 17. Gain vs. Frequency and Temperature

09353-017

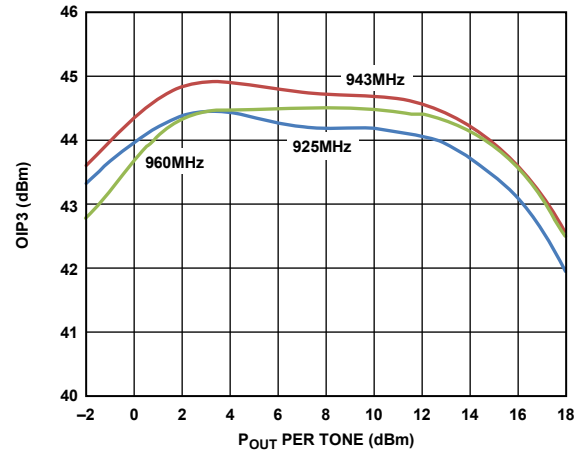

Figure 20. OIP3 vs.  $P_{OUT}$  and Frequency

09353-020

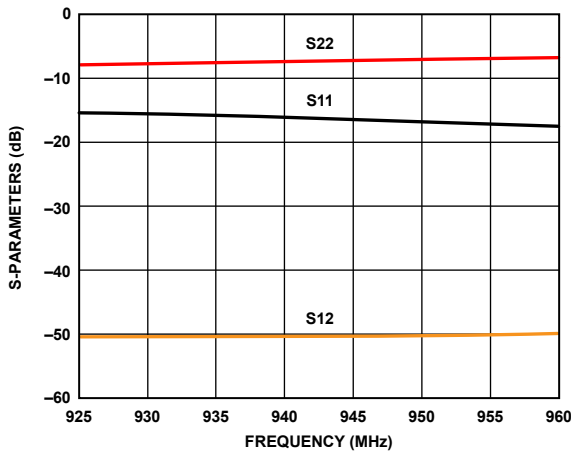

Figure 18. Input Return Loss (S11), Output Return Loss (S22), and Reverse Isolation (S12) vs. Frequency

09353-018

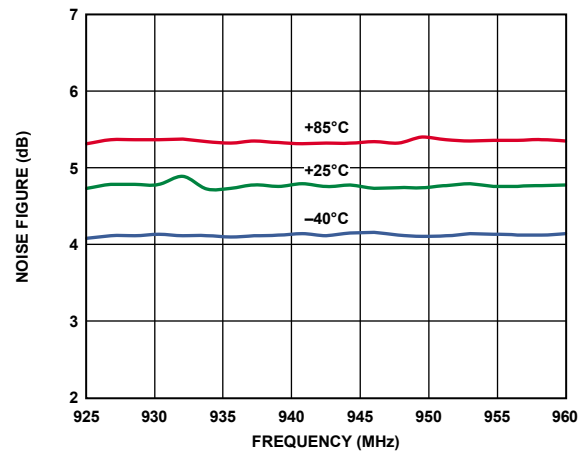

Figure 21. Noise Figure vs. Frequency and Temperature

09353-021

GENERAL

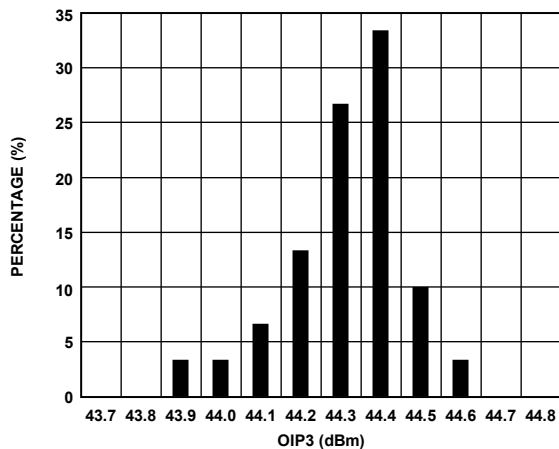

Figure 22. OIP3 Distribution at 943 MHz, 14 dBm per Tone

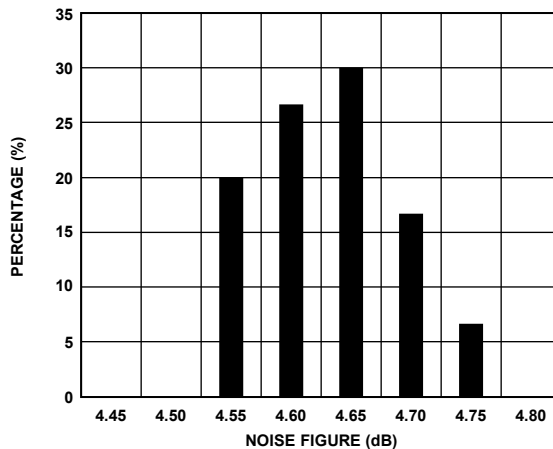

Figure 25. Noise Figure Distribution at 943 MHz

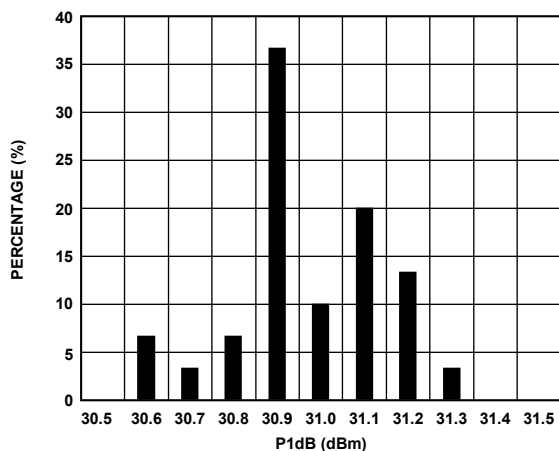

Figure 23. P1dB Distribution at 943 MHz

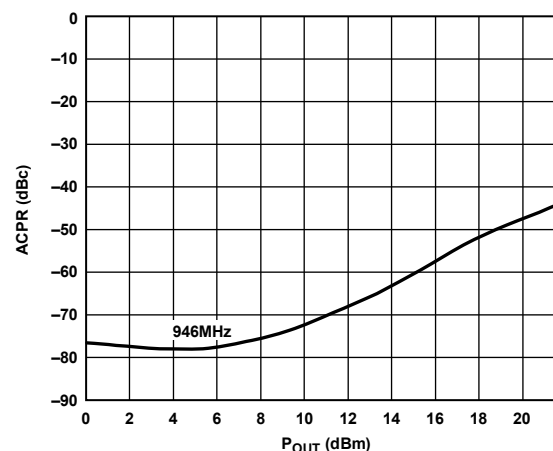

Figure 26. ACPR vs.  $P_{OUT}$ , 3GPP, TM1-64, at 946 MHz

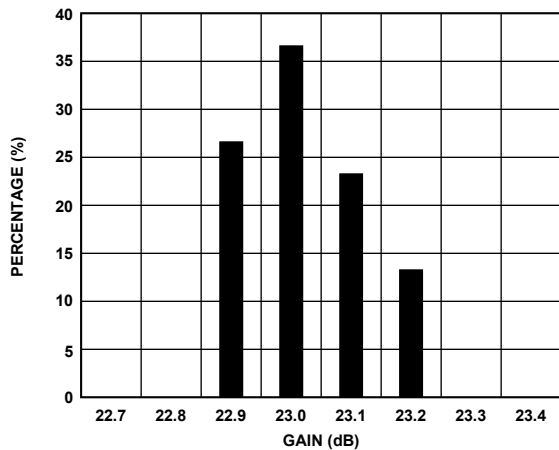

Figure 24. Gain Distribution at 943 MHz

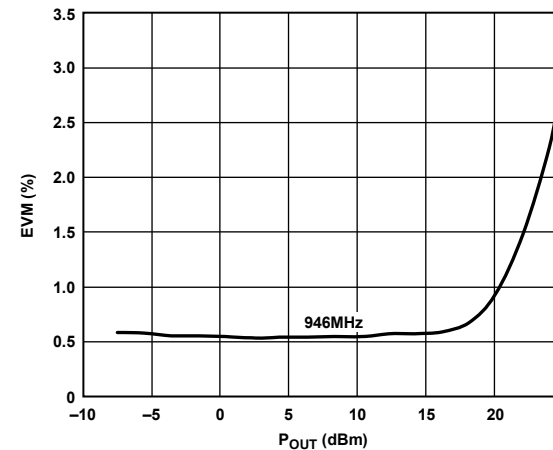

Figure 27. EVM vs.  $P_{OUT}$ , 3GPP, TM1-64, at 946 MHz

# ADL5605

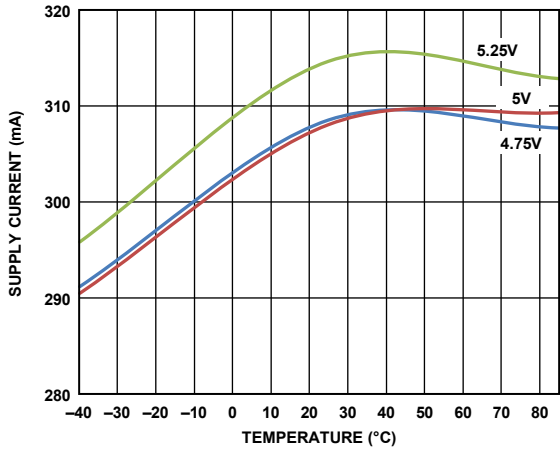

Figure 28. Supply Current vs. Temperature and Supply Voltage at 943 MHz

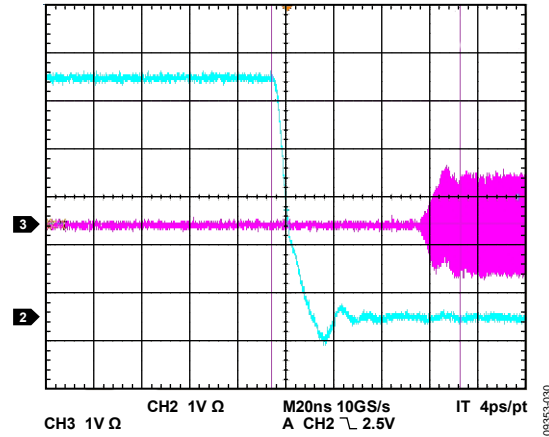

Figure 30. Turn-On Time, 10% of Control Pulse to 90% of RFOUT

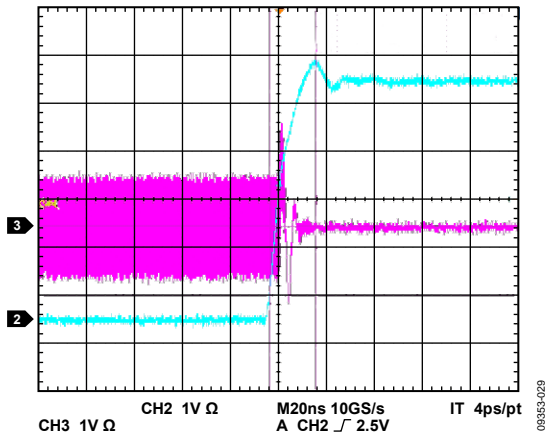

Figure 29. Turn-Off Time, 10% of Control Pulse to 90% of RFOUT

## APPLICATIONS INFORMATION

### BASIC LAYOUT CONNECTIONS

The basic connections for operating the ADL5605 are shown in Figure 31. The RF matching components correspond to the 943 MHz frequency tuning band.

#### Power Supply

The voltage supply for the ADL5605, which ranges from 4.75 V to 5.25 V, should be connected to the VCC1 test pin. The dc bias to the output stage is supplied through L1 and is connected to the RFOUT pin. Three decoupling capacitors (C7, C8, and C9) are used to prevent RF signals from propagating on the dc lines. The VBIAS and VCC pins can be directly connected to the main supply voltage. Additional decoupling capacitors (C5, C6, C11, C12, C13, and C14) are required on the VCC and VBIAS pins.

#### RF Input Interface

Pin 1 is the RF input pin for the ADL5605. The RF input is easily matched to 50  $\Omega$  with only one shunt capacitor and the microstrip line used as an inductor. For the 881 MHz and 943 MHz frequency tuning bands, the input requires no external matching components.

For complete information about component values and spacing for the different frequency tuning bands, see the ADL5605 Matching section.

#### RF Output Interface

Pin 9 to Pin 12 are the RF output pins. Inductor L2, the shunt capacitor, C<sub>OUT</sub>, and the inductance from the microstrip line are used to match the RF output to 50  $\Omega$ . For complete information about component values and spacing for the different frequency tuning bands, see the ADL5605 Matching section.

#### Power-Down

The ADL5605 can be disabled by connecting the DISABLE pin to 5 V. When disabled, the ADL5605 draws approximately 5 mA of current from the power supply and 1.4 mA from the DISABLE pin. Decoupling Capacitor C3 is recommended to prevent the propagation of RF signals. To completely shut down the device, connect the VCC pin, the VBIAS pin, and the VCC1 test pin to ground. In this state, the part draws approximately 1.4 mA from the DISABLE pin.

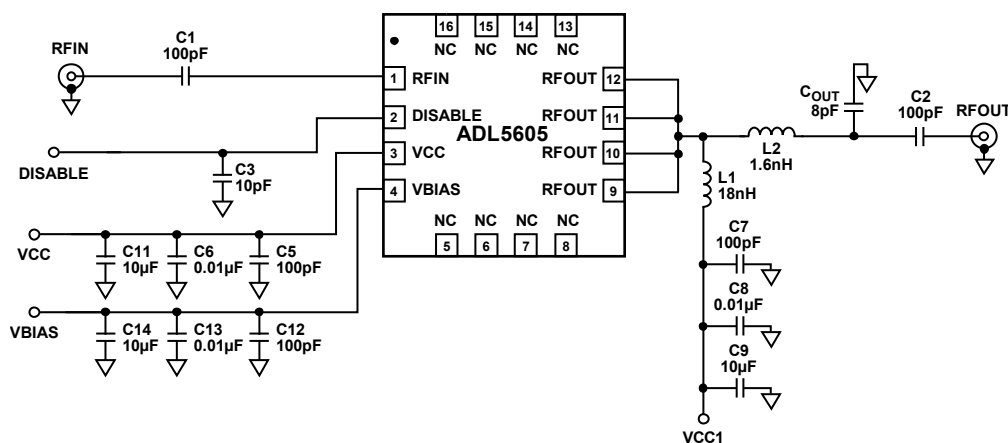

Figure 31. Basic Connections

09385-1031

# ADL5605

## ADL5605 MATCHING

The RF input of the [ADL5605](#) can be easily matched to 50 Ω with at most one external component and the microstrip line used as an inductor. The RF output requires one series inductor, one shunt capacitor, and the microstrip line used as an inductor. Table 6 lists the required matching component values. Capacitors  $C_{IN}$  and  $C_{OUT}$  are Murata GRM155 series (0402 size), and Inductor L2 is a Coilcraft® 0603CS series (0603 size).

For all frequency tuning bands, the placement of  $C_{IN}$ , L2, and  $C_{OUT}$  is critical. Table 7 lists the recommended component spacing for the various frequency tuning bands. The component spacing is referenced from the center of the component to the edge of the package.

Figure 32 to Figure 34 show the matching networks.

**Table 6. Recommended Components for Basic Connections**

Frequency (MHz)	$C_{IN}$ (pF)	L2 (nH)	$C_{OUT}$ (pF)
728 to 768	2.4	2.7	12.0
868 to 894	N/A	1.6	8.0
925 to 961	N/A	1.6	8.0

**Table 7. Matching Component Spacing**

Frequency (MHz)	$\lambda_1$ (mils)	$\lambda_2$ (mils)	$\lambda_3$ (mils)
728 to 768	63	94.5	169
868 to 894	N/A	94.5	268
925 to 961	N/A	94.5	240

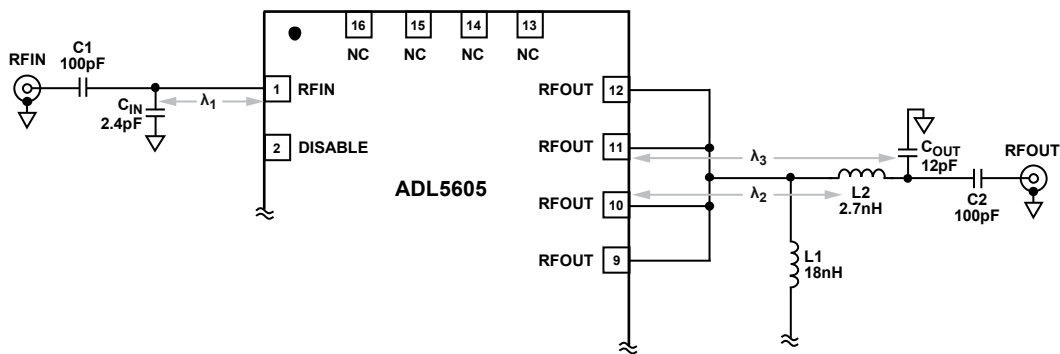

Figure 32. [ADL5605](#) Match Parameters, 748 MHz Frequency Tuning Band

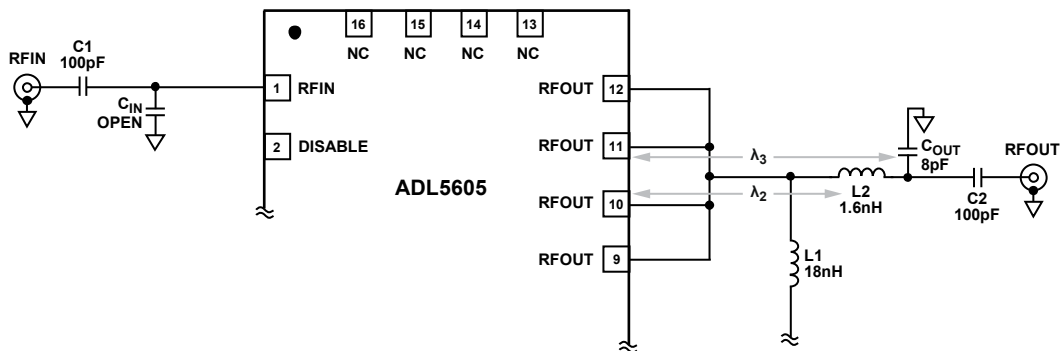

Figure 33. [ADL5605](#) Match Parameters, 881 MHz Frequency Tuning Band

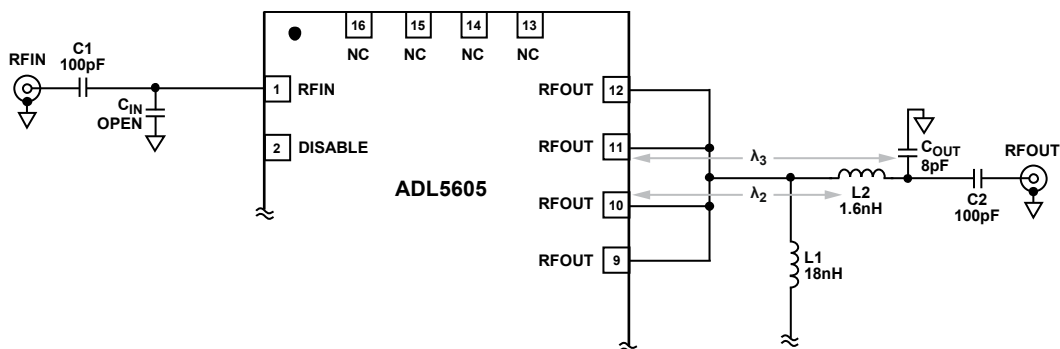

Figure 34. [ADL5605](#) Match Parameters, 943 MHz Frequency Tuning Band

## ACPR AND EVM

All adjacent channel power ratio (ACPR) and error vector magnitude (EVM) measurements were made using a single W-CDMA carrier and Test Model 1-64.

The signal is generated by a very low ACPR source and is measured at the output by a high dynamic range spectrum analyzer. For ACPR measurements, the filter setting was chosen for low ACPR; for EVM measurements, the low EVM setting was selected. The spectrum analyzer incorporates an instrument noise correction function, and highly linear amplifiers were used to boost the power levels for ACPR measurements.

Figure 26 shows ACPR vs.  $P_{OUT}$  at 946 MHz. For power levels up to 18 dBm, an ACPR of 51 dBc or better can be achieved at 946 MHz.

Figure 27 shows EVM vs.  $P_{OUT}$  at 946 MHz. The EVM measured is 0.5% for power levels up to 18 dBm at 946 MHz. The baseline composite EVM for the signal source was approximately 0.5%. When operated in the linear region, there is little or no contribution to EVM by the amplifier.

## THERMAL CONSIDERATIONS

The ADL5605 is packaged in a thermally efficient 4 mm × 4 mm, 16-lead LFCSP. The thermal resistance from junction to air ( $\theta_{JA}$ ) is 52.1°C/W. The thermal resistance for the product was extracted assuming a standard 4-layer JEDEC board with 25 copper plated thermal vias. The thermal vias are filled with conductive copper paste (AE3030 with thermal conductivity of 7.8 W/mK and thermal expansion  $\alpha_1$  of  $4 \times 10^{-5}/^{\circ}\text{C}$  and  $\alpha_2$  of  $8.6 \times 10^{-5}/^{\circ}\text{C}$ ). The thermal resistance from junction to case ( $\theta_{JC}$ ) is 12.1°C/W, where the case is the exposed pad of the lead frame package.

For the best thermal performance, it is recommended that as many thermal vias as possible be added under the exposed pad of the LFCSP. The thermal resistance values assume a minimum of 25 thermal vias arranged in a 5 × 5 array with a via diameter of 8 mils, via pad of 16 mils, and a pitch of 20 mils. The vias are plated with copper, and the drill hole is filled with a conductive copper paste.

For optimal performance, it is recommended that the thermal vias be filled with a conductive paste of the equivalent thermal conductivity specified earlier in this section; alternatively, an external heat sink can be used to dissipate heat quickly without affecting the die junction temperature. It is also recommended that the ground pattern be extended above and below the device to improve thermal efficiency (see Figure 35).

## SOLDERING INFORMATION AND RECOMMENDED PCB LAND PATTERN

Figure 35 shows the recommended land pattern for the ADL5605. To minimize thermal impedance, the exposed paddle on the 4 mm × 4 mm LFCSP is soldered to a ground plane along with Pin 5 to Pin 8 and Pin 13 to Pin 16. To improve thermal dissipation, 25 thermal vias are arranged in a 5 × 5 array under the exposed paddle. Areas above and below the paddle are tied with regular vias. If multiple ground layers exist, they should be tied together using vias. For more information about land pattern design and layout, see the AN-772 Application Note, *A Design and Manufacturing Guide for the Lead Frame Chip Scale Package (LFCSP)*.

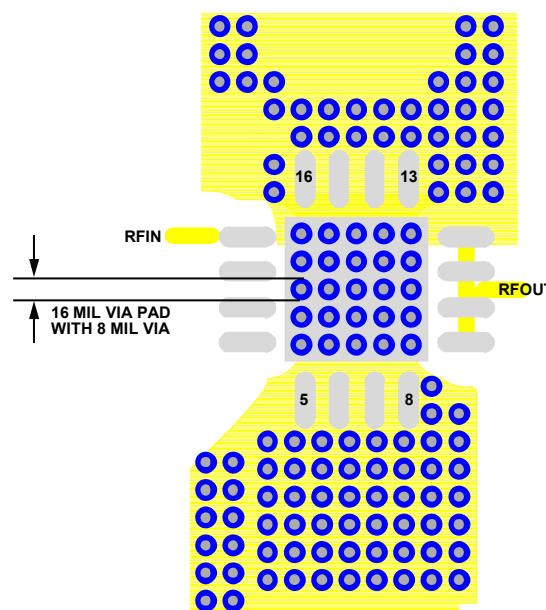

Figure 35. Recommended Land Pattern

00353-035

## EVALUATION BOARD

The schematic of the [ADL5605](#) evaluation board is shown in Figure 36. The evaluation board uses 25 mils wide, 50 Ω traces and is made from IS410 material with a 20 mils gap to ground. The evaluation board is tuned for operation at 943 MHz. The inputs and outputs should be ac-coupled with appropriately sized capacitors; therefore, for low frequency applications, the value of C1 and C2 may need to be increased. DC bias is provided to the output stage via an inductor (L1) connected to the RFOUT pin. A bias voltage of 5 V is recommended.

The evaluation board has a short, non-50 Ω line on its output to accommodate the four output pins and to allow for easier low inductance output matching. The pads for Pin 9 to Pin 12 are included on this microstrip line and are included in all matches. The evaluation board uses numbers as identifiers to aid in the placement of matching components at both the RF input and RF output of the device. Figure 37 and Figure 38 show images of the board layout.

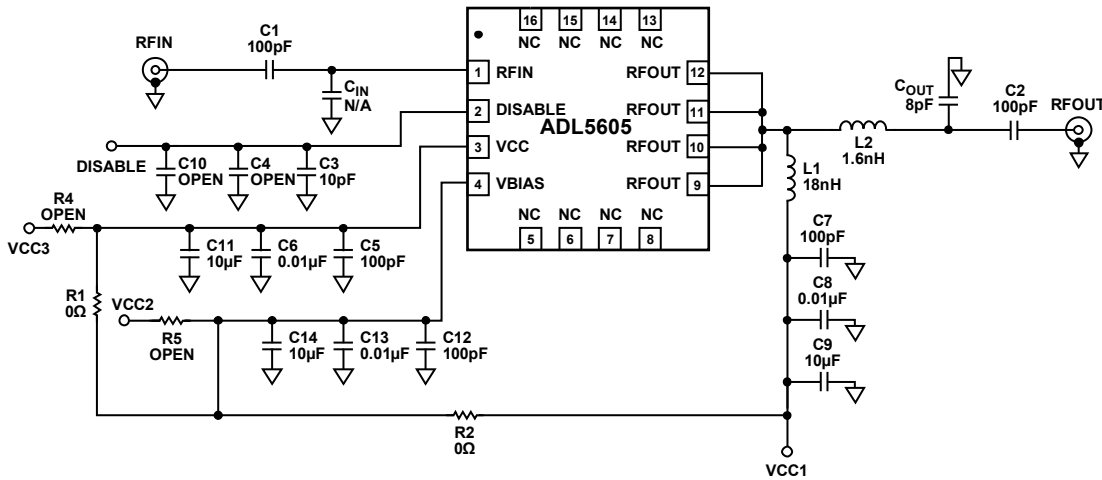
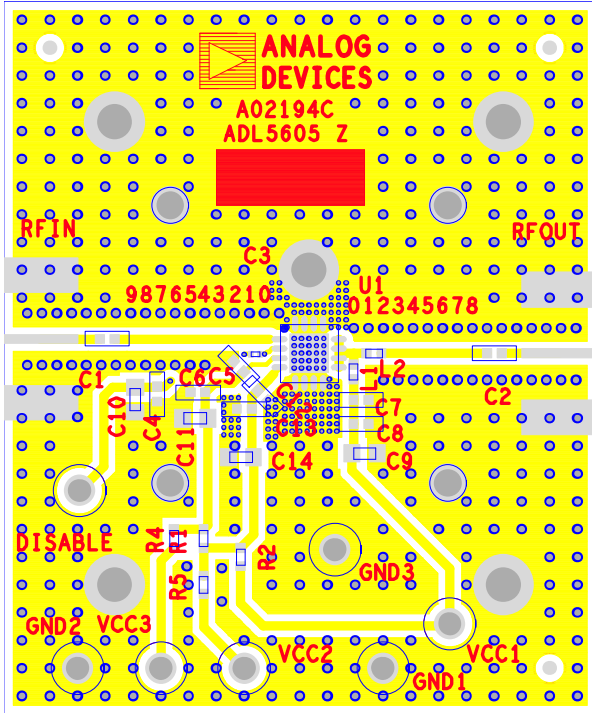

Figure 36. Evaluation Board, 943 MHz Frequency Tuning Band

Table 8. Evaluation Board Configuration Options, 943 MHz Frequency Tuning Band

Component	Function/Notes	Default Value
C1, C2	Input/output dc blocking capacitors.	C1, C2 = 100 pF
C3, C4, C5, C6, C7, C8, C9, C10, C11, C12, C13, C14	Power supply decoupling capacitors. Power supply decoupling capacitors are required to filter out the high frequency noise on the power supply. The smallest capacitor should be the closest to the <a href="#">ADL5605</a> . The main bias that goes through RFOUT is the most sensitive to noise because the bias is connected directly to the RF output.	C3 = 10 pF C5, C7, C12 = 100 pF C6, C8, C13 = 0.01 μF C9, C11, C14 = 10 μF C4, C10 = open
C <sub>IN</sub>	Input matching capacitor. To match the <a href="#">ADL5605</a> at the 943 MHz or 881 MHz frequency tuning band, C <sub>IN</sub> is not required. For the 748 MHz frequency tuning band, C <sub>IN</sub> is set at a specific distance from the device so that the microstrip line can act as inductance for the matching network (see Table 7). If space is at a premium, an inductor can take the place of the microstrip line.	C <sub>IN</sub> = open
C <sub>OUT</sub>	Output matching capacitor. The output match is set for 943 MHz and is easily changed for other frequency tuning bands. The tolerance of this capacitor should be tight. C <sub>OUT</sub> is set at a specific distance from the device so that the microstrip line can act as inductance for the matching network (see Table 7). If space is at a premium, an inductor can take the place of the microstrip line. A short length of low impedance line on the output is embedded in the match.	C <sub>OUT</sub> = 8.0 pF HQ
L2	Output matching inductor. The output match is set for 943 MHz and is easily changed for other frequency tuning bands. A high Q Coilcraft inductor with tight tolerance is recommended.	L2 = 1.6 nH HQ
L1	The main bias for the <a href="#">ADL5605</a> comes through L1 to the output stage. L1 should be high impedance for the frequency of operation while providing low resistance for the dc current. The evaluation board uses a Coilcraft 0603HP-18NX_LU inductor; this 18 nH inductor provides some of the match at 943 MHz.	L1 = 18 nH
R1, R2, R4, R5	To provide bias to all stages through just one supply, set R1 and R2 to 0 Ω, and leave R4 and R5 open. To provide separate bias to stages, set R1 and R2 to open and R4 and R5 to 0 Ω.	R1, R2 = 0 Ω R4, R5 = open
Exposed Paddle	The paddle should be connected to both thermal and electrical ground.	





09353-037

Figure 37. Evaluation Board Layout, Top

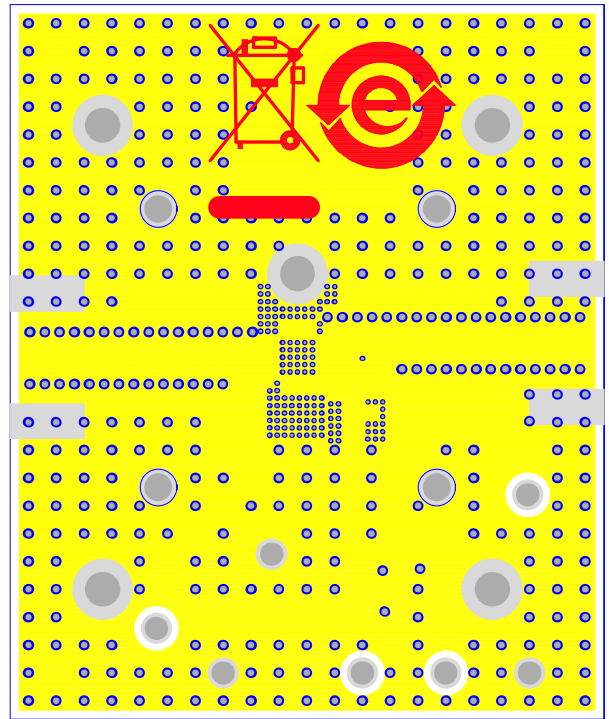

09353-038

Figure 38. Evaluation Board Layout, Bottom

OUTLINE DIMENSIONS

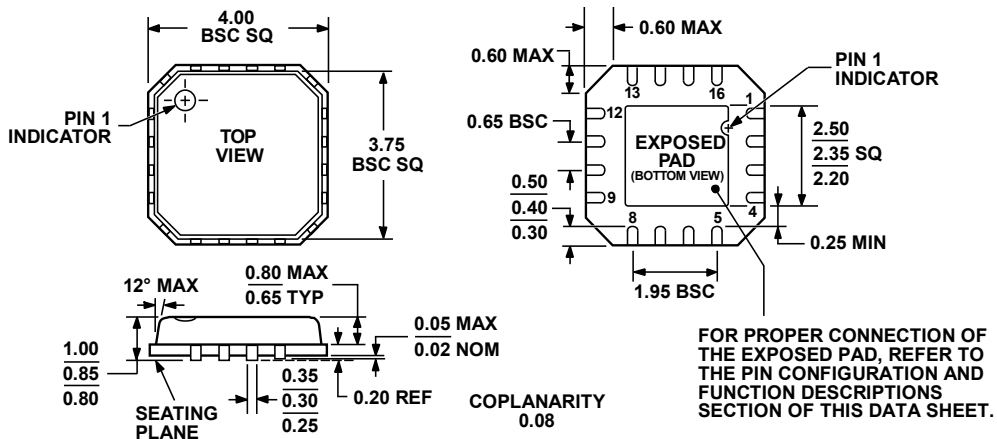

COMPLIANT TO JEDEC STANDARDS MO-220-VGGC

Figure 39. 16-Lead Lead Frame Chip Scale Package [LFCSP\_VQ]  
 4 mm × 4 mm Body, Very Thin Quad  
 (CP-16-10)  
 Dimensions shown in millimeters

082008-A

ORDERING GUIDE

Model <sup>1</sup>	Temperature Range	Package Description	Package Option
ADL5605ACPZ-R7	-40°C to +85°C	16-Lead Lead Frame Chip Scale Package [LFCSP_VQ]	CP-16-10
ADL5605-EVALZ		Evaluation Board	

<sup>1</sup> Z = RoHS Compliant Part.

**NOTES**

**ADL5605**

**NOTES**