

## Install in 22-dia. or 25-dia. Panel Cutout (When Using a Ring)



- Lever for easily mounting and removing the Switch Unit.
- Increase wiring efficiency with three-row mounting of Switch Blocks.
- Finger protection mechanism on Switch Unit provided as a standard feature.
- Use 25-dia. ring to install in 25-dia. panel cutouts.
- Mounted using either open-type (fork-type) or closed-type (round-type) crimp terminals.
- IP65 oil resistance (non-lighted models)  
IP65 (lighted models)





 Refer to *Safety Precautions for All Pushbutton Switches and Safety Precautions* on page 23.

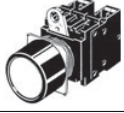
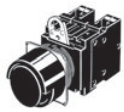

## List of Models

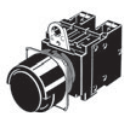
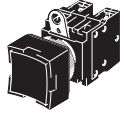
### Non-lighted Pushbutton Switches

Appearance	Model number
Flat 	A22-F
Projected 	A22-T
Full guard 	A22-G
Half guard 	A22-H

Appearance	Model number
Projected 	A22-C
Guard 	A22-D
Mushroom Small (30 dia.) 	A22-S
Mushroom Medium (40 dia.) 	A22-M

### Lighted Pushbutton Switches

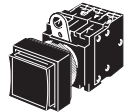
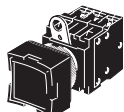
Appearance	Model number
Projected 	A22L-T
Full guard 	A22L-G
Half guard 	A22L-H
Projected 	A22L-C
Guard 	A22L-D

## Model Number Structure

**Model Number Legend** ..... Shipped as a set which includes the Pushbutton, Lamp (lighted type only), and Switch.  
For information on combinations, refer to *Ordering Information* on pages 3 to 6.

(1) (2) (3) (4) (5) (6)  
A 22 **L** - **T** **R** - **12 A** - **10** **M**

(1) Type		(2) Flange Shape Non-lighted			(3) Illumination Color		(4) Light Source Without Voltage Reduction Unit			(5) Contacts	
Code	Description	Code	Description		Code	Description	Code	Operating Voltage		Code	Description
No symbol	Non-lighted	F	Round	Flat	R	Red	No symbol	Non-lighted		10	SPST-NO
L	Lighted	T		Projected	G	Green	6A	LED	6 VAC/VDC	01	SPST-NC
		G		Full-guard	Y	Yellow	12A		12 VAC/VDC	11	SPST-NO + SPST-NC
		H		Half-guard	W	White	24A		24 VAC/VDC	20	DPST-NO
		C	Square	Projected	A	Blue	5	Incandescent lamp	5 VAC/VDC	02	DPST-NC
		D		Full-guard	B	Black*	12		12 VAC/VDC	Note: 1. The contact ratings are for standard loads. For microloads, select from the accessories on page 10. 2. Refer to page 13 for contact ratings.	
		S	Round	Mushroom Small (30 dia.)	* For non-lighted type only		24		24 VAC/VDC		
		M		Mushroom Medium (40 dia.)							
(1) Type		(2) Flange Shape Lighted			(3) Illumination Color		(4) Light Source With Voltage Reduction Unit			(5) Contacts	
Code	Description	Code	Description		Code	Description	Code	Operating Voltage		Code	Description
T	Projection	T	Round	Projection	R	Red	T1	LED	100 VAC		
G	Full-guard	G		Full-guard	G	Green	T2		200 VAC		
H	Half-guard	H		Half-guard	Y	Yellow					
C	Projection	C	Square	Projection	W	White					
D	Full-guard	D		Full-guard	A	Blue					
					B	Black*					
					* For non-lighted type only						

■ Specifications: See pages 13 to 14.



■ Dimensions: Refer to page 16.

■ Precautions for correct use: Refer to page 23.

■ Accessories and tools: See pages 10 to 12.

## Ordering Information

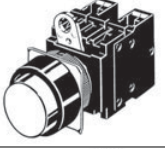
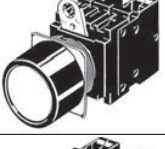
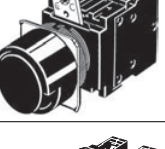
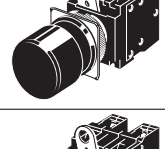
**Completely Assembled**..... Shipped as a set which includes the Pushbutton, Lamp (lighted type only), and Switch.  
**Non-lighted (Round Type)**

Appearance	Operation Output	Momentary operation (self-resetting)	Alternate operation (self-holding)	Illumination color
		Set	Set	
Round/Flat type A22-F 	SPST-NO	A22-F□-10M	A22-F□-10A	R (red) Y (yellow) G (green) W (white) A (blue) B (black)
	SPST-NC	A22-F□-01M	A22-F□-01A	
	SPST-NO + SPST-NC	A22-F□-11M	A22-F□-11A	
	DPST-NO	A22-F□-20M	A22-F□-20A	
	DPST-NC	A22-F□-02M	A22-F□-02A	
Round/Projection type A22-T 	SPST-NO	A22-T□-10M	A22-T□-10A	
	SPST-NC	A22-T□-01M	A22-T□-01A	
	SPST-NO + SPST-NC	A22-T□-11M	A22-T□-11A	
	SPST-NO + SPST-NO	A22-T□-20M	A22-T□-20A	
	SPST-NC + SPST-NC	A22-T□-02M	A22-T□-02A	
Round/Full-guard type A22-G 	SPST-NO	A22-G□-10M	A22-G□-10A	
	SPST-NC	A22-G□-01M	A22-G□-01A	
	SPST-NO + SPST-NC	A22-G□-11M	A22-G□-11A	
	SPST-NO + SPST-NO	A22-G□-20M	A22-G□-20A	
	SPST-NC + SPST-NC	A22-G□-02M	A22-G□-02A	
Round/Half-guard type A22-H 	SPST-NO	A22-H□-10M	A22-H□-10A	
	SPST-NC	A22-H□-01M	A22-H□-01A	
	SPST-NO + SPST-NC	A22-H□-11M	A22-H□-11A	
	SPST-NO + SPST-NO	A22-H□-20M	A22-H□-20A	
	SPST-NC + SPST-NC	A22-H□-02M	A22-H□-02A	
Round/Small-size Mushroom type (30-dia. head) A22-S 	SPST-NO	A22-S□-10M	---	
	SPST-NC	A22-S□-01M		
	SPST-NO + SPST-NC	A22-S□-11M		
	SPST-NO + SPST-NO	A22-S□-20M		
	SPST-NC + SPST-NC	A22-S□-02M		
Round/Medium-size Mushroom type (40-dia head) A22-M 	SPST-NO	A22-M□-10M		
	SPST-NC	A22-M□-01M		
	SPST-NO + SPST-NC	A22-M□-11M		
	SPST-NO + SPST-NO	A22-M□-20M		
	SPST-NC + SPST-NC	A22-M□-02M		

Note: The contact ratings are for standard loads.

### Non-lighted (Square Type)

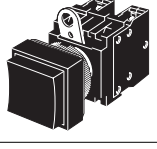
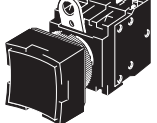
Appearance	Operation Output	Momentary operation (self-resetting)	Alternate operation (self-holding)	Illumination color
		Set	Set	
Square/Projection type A22-C 	SPST-NO	A22-C□-10M	A22-C□-10A	R (red) Y (yellow) G (green) W (white) A (blue) B (black)
	SPST-NC	A22-C□-01M	A22-C□-01A	
	SPST-NO + SPST-NC	A22-C□-11M	A22-C□-11A	
	SPST-NO + SPST-NO	A22-C□-20M	A22-C□-20A	
	SPST-NC + SPST-NC	A22-C□-02M	A22-C□-02A	
Square/Guard type A22-D 	SPST-NO	A22-D□-10M	A22-D□-10A	
	SPST-NC	A22-D□-01M	A22-D□-01A	
	SPST-NO + SPST-NC	A22-D□-11M	A22-D□-11A	
	SPST-NO + SPST-NO	A22-D□-20M	A22-D□-20A	
	SPST-NC + SPST-NC	A22-D□-02M	A22-D□-02A	

Note: The contact ratings are for standard loads.

Individual models: Refer to pages 7 to 9.  
 (The Pushbutton, Lamp, and Switch can be ordered



■ Specifications: See pages 13 to 14. ■ Dimensions: Refer to page 16.  
 ■ Accessories and tools: See pages 10 to 12.

## Ordering Information

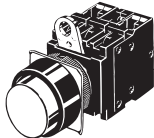
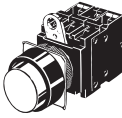
**Completely Assembled** ..... Shipped as a set which includes the Pushbutton, Lamp (lighted type only), and Switch.  
**Lighted (Round Type)**

Appearance	Output	Lighting	Operation		Illumination color	
			Operating voltage	Momentary operation (self-resetting) Set		Alternate operation (self-holding) Set
Round/Projection type LED lighting (without Voltage Reduction Unit) A22L-T 	SPST-NO	LED	6 VAC/VDC	A22L-T□-6A-10M	A22L-T□-6A-10A	R (red) Y (yellow) G (green) W (white) A (blue)
			12 VAC/VDC	A22L-T□-12A-10M	A22L-T□-12A-10A	
			24 VAC/VDC	A22L-T□-24A-10M	A22L-T□-24A-10A	
	SPST-NC		6 VAC/VDC	A22L-T□-6A-01M	A22L-T□-6A-01A	
			12 VAC/VDC	A22L-T□-12A-01M	A22L-T□-12A-01A	
			24 VAC/VDC	A22L-T□-24A-01M	A22L-T□-24A-01A	
	SPST-NO + SPST-NC		6 VAC/VDC	A22L-T□-6A-11M	A22L-T□-6A-11A	
			12 VAC/VDC	A22L-T□-12A-11M	A22L-T□-12A-11A	
			24 VAC/VDC	A22L-T□-24A-11M	A22L-T□-24A-11A	
	SPST-NO + SPST-NO		6 VAC/VDC	A22L-T□-6A-20M	A22L-T□-6A-20A	
			12 VAC/VDC	A22L-T□-12A-20M	A22L-T□-12A-20A	
			24 VAC/VDC	A22L-T□-24A-20M	A22L-T□-24A-20A	
SPST-NC + SPST-NC	6 VAC/VDC	A22L-T□-6A-02M	A22L-T□-6A-02A			
	12 VAC/VDC	A22L-T□-12A-02M	A22L-T□-12A-02A			
	24 VAC/VDC	A22L-T□-24A-02M	A22L-T□-24A-02A			
Round/Projection type LED voltage-reduction lighting (with Voltage Reduction Unit) A22L-T 	SPST-NO	100 VAC	A22L-T□-T1-10M	A22L-T□-T1-10A		
	SPST-NC	200 VAC	A22L-T□-T2-10M	A22L-T□-T2-10A		
		100 VAC	A22L-T□-T1-01M	A22L-T□-T1-01A		
	SPST-NO + SPST-NC	200 VAC	A22L-T□-T2-01M	A22L-T□-T2-01A		
		100 VAC	A22L-T□-T1-11M	A22L-T□-T1-11A		
	SPST-NO + SPST-NO	200 VAC	A22L-T□-T2-11M	A22L-T□-T2-11A		
		100 VAC	A22L-T□-T1-20M	A22L-T□-T1-20A		
	SPST-NC + SPST-NO	200 VAC	A22L-T□-T2-20M	A22L-T□-T2-20A		
		100 VAC	A22L-T□-T1-02M	A22L-T□-T1-02A		
	SPST-NC	200 VAC	A22L-T□-T2-02M	A22L-T□-T2-02A		

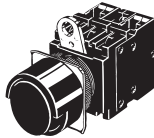
Note: The contact ratings are for standard loads.

Appearance	Output	Lighting	Operation		Illumination color	
			Operating voltage	Momentary operation (self-resetting) Set		Alternate operation (self-holding) Set
Round/Half-guard type LED lighting (without Voltage Reduction Unit) A22L-H 	SPST-NO	LED	24 VAC/VDC	A22L-H□-24A-10M	A22L-H□-24A-10A	R (red) Y (yellow) G (green) W (white) A (blue)
	SPST-NC			A22L-H□-24A-01M	A22L-H□-24A-01A	
	SPST-NO + SPST-NC			A22L-H□-24A-11M	A22L-H□-24A-11A	
	SPST-NO + SPST-NO			A22L-H□-24A-20M	A22L-H□-24A-20A	
	SPST-NC + SPST-NC			A22L-H□-24A-02M	A22L-H□-24A-02A	
Round/Half-guard type LED voltage-reduction lighting (with Voltage Reduction Unit) A22L-H 	SPST-NO	100 VAC	A22L-H□-T1-10M	A22L-H□-T1-10A		
	SPST-NC	200 VAC	A22L-H□-T2-10M	A22L-H□-T2-10A		
		100 VAC	A22L-H□-T1-01M	A22L-H□-T1-01A		
	SPST-NO + SPST-NC	200 VAC	A22L-H□-T2-01M	A22L-H□-T2-01A		
		100 VAC	A22L-H□-T1-11M	A22L-H□-T1-11A		
	SPST-NO + SPST-NO	200 VAC	A22L-H□-T2-11M	A22L-H□-T2-11A		
		100 VAC	A22L-H□-T1-20M	A22L-H□-T1-20A		
	SPST-NC + SPST-NO	200 VAC	A22L-H□-T2-20M	A22L-H□-T2-20A		
		100 VAC	A22L-H□-T1-02M	A22L-H□-T1-02A		
	SPST-NC	200 VAC	A22L-H□-T2-02M	A22L-H□-T2-02A		

Note: The contact ratings are for standard loads.

Individual models: Refer to pages 7 to 9.  
 (The Pushbutton, Lamp, and Switch can be ordered separately.)

■ Specifications and dimensions: See pages 13 to 16.  
 ■ Accessories and tools: See pages 10 to 12.

## Ordering Information

**Completely Assembled**..... Shipped as a set which includes the Pushbutton, Lamp (lighted type only), and Switch.  
**Lighted (Round Type)**

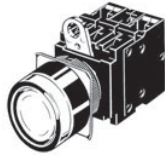
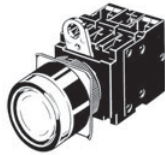
Appearance	Output	Lighting	Operation	Momentary operation (self-resetting)	Alternate operation (self-holding)	Illumination color
			Operating voltage	Set	Set	
Round/Full-guard type LED lighting (without Voltage Reduction Unit) A22L-G 	SPST-NO	LED	6 VAC/VDC	A22L-G□-6A-10M	A22L-G□-6A-10A	R (red) Y (yellow) G (green) W (white) A (blue)
			12 VAC/VDC	A22L-G□-12A-10M	A22L-G□-12A-10A	
			24 VAC/VDC	A22L-G□-24A-10M	A22L-G□-24A-10A	
	SPST-NC		6 VAC/VDC	A22L-G□-6A-01M	A22L-G□-6A-01A	
			12 VAC/VDC	A22L-G□-12A-01M	A22L-G□-12A-01A	
			24 VAC/VDC	A22L-G□-24A-01M	A22L-G□-24A-01A	
	SPST-NO + SPST-NC		6 VAC/VDC	A22L-G□-6A-11M	A22L-G□-6A-11A	
			12 VAC/VDC	A22L-G□-12A-11M	A22L-G□-12A-11A	
			24 VAC/VDC	A22L-G□-24A-11M	A22L-G□-24A-11A	
	SPST-NO + SPST-NO		6 VAC/VDC	A22L-G□-6A-20M	A22L-G□-6A-20A	
			12 VAC/VDC	A22L-G□-12A-20M	A22L-G□-12A-20A	
			24 VAC/VDC	A22L-G□-24A-20M	A22L-G□-24A-20A	
Round/Full-guard type LED voltage-reduction lighting (with Voltage Reduction Unit) A22L-G 	SPST-NO	100 VAC	A22L-G□-T1-10M	A22L-G□-T1-10A		
		200 VAC	A22L-G□-T2-10M	A22L-G□-T2-10A		
	SPST-NC	100 VAC	A22L-G□-T1-01M	A22L-G□-T1-01A		
		200 VAC	A22L-G□-T2-01M	A22L-G□-T2-01A		
	SPST-NO + SPST-NC	100 VAC	A22L-G□-T1-11M	A22L-G□-T1-11A		
		200 VAC	A22L-G□-T2-11M	A22L-G□-T2-11A		
SPST-NO + SPST-NO	100 VAC	A22L-G□-T1-20M	A22L-G□-T1-20A			
	200 VAC	A22L-G□-T2-20M	A22L-G□-T2-20A			
SPST-NC + SPST-NC	100 VAC	A22L-G□-T1-02M	A22L-G□-T1-02A			
	200 VAC	A22L-G□-T2-02M	A22L-G□-T2-02A			

Note: The contact ratings are for standard loads.

Individual models: Refer to pages 7 to 9.  
 (The Pushbutton, Lamp, and Switch can be ordered separately.)

■ Specifications and dimensions: Refer to pages 13 to 16.  
 ■ Accessories and tools: See pages 10 to 12.

## Ordering Information

**Completely Assembled** ..... Shipped as a set which includes the Pushbutton, Lamp (lighted type only), and Switch.  
**Lighted (Square Type)**

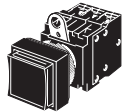
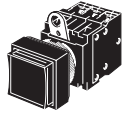
Appearance	Output	Lighting	Operation Operating voltage	Momentary operation (self-resetting)	Alternate operation (self-holding)	Illumination color
				Set	Set	
Square/Projection type LED lighting (without Voltage Reduction Unit) A22L-C  	SPST-NO	LED	24 VAC/VDC	A22L-C□-24A-10M	A22L-C□-24A-10A	R (red) Y (yellow) G (green) W (white) A (blue)
	SPST-NC			A22L-C□-24A-01M	A22L-C□-24A-01A	
	SPST-NO + SPST-NC			A22L-C□-24A-11M	A22L-C□-24A-11A	
	SPST-NO + SPST-NO			A22L-C□-24A-20M	A22L-C□-24A-20A	
	SPST-NC + SPST-NC			A22L-C□-24A-02M	A22L-C□-24A-02A	
Square/Projection type LED voltage-reduction lighting (with Voltage Reduction Unit) A22L-C  	SPST-NO	100 VAC	A22L-C□-T1-10M	A22L-C□-T1-10A		
	SPST-NC	200 VAC	A22L-C□-T2-10M	A22L-C□-T2-10A		
		100 VAC	A22L-C□-T1-01M	A22L-C□-T1-01A		
	SPST-NO + SPST-NC	200 VAC	A22L-C□-T2-01M	A22L-C□-T2-01A		
		100 VAC	A22L-C□-T1-11M	A22L-C□-T1-11A		
	SPST-NO + SPST-NO	200 VAC	A22L-C□-T2-11M	A22L-C□-T2-11A		
		100 VAC	A22L-C□-T1-20M	A22L-C□-T1-20A		
	SPST-NC + SPST-NC	200 VAC	A22L-C□-T2-20M	A22L-C□-T2-20A		
		100 VAC	A22L-C□-T1-02M	A22L-C□-T1-02A		
			200 VAC	A22L-C□-T2-02M	A22L-C□-T2-02A	

Note: The contact ratings are for standard loads.

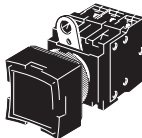
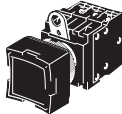
Appearance	Output	Lighting	Operation Operating voltage	Momentary operation (self-resetting)	Alternate operation (self-holding)	Illumination color
				Set	Set	
Square/Full-guard type LED lighting (without Voltage Reduction Unit) A22L-D  	SPST-NO	LED	24 VAC/VDC	A22L-D□-24A-10M	A22L-D□-24A-10A	R (red) Y (yellow) G (green) W (white) A (blue)
	SPST-NC			A22L-D□-24A-01M	A22L-D□-24A-01A	
	SPST-NO + SPST-NC			A22L-D□-24A-11M	A22L-D□-24A-11A	
	SPST-NO + SPST-NO			A22L-D□-24A-20M	A22L-D□-24A-20A	
	SPST-NC + SPST-NC			A22L-D□-24A-02M	A22L-D□-24A-02A	
Square/Full-guard type LED voltage-reduction lighting (with Voltage Reduction Unit) A22L-D  	SPST-NO	100 VAC	A22L-D□-T1-10M	A22L-D□-T1-10A		
	SPST-NC	200 VAC	A22L-D□-T2-10M	A22L-D□-T2-10A		
		100 VAC	A22L-D□-T1-01M	A22L-D□-T1-01A		
	SPST-NO + SPST-NC	200 VAC	A22L-D□-T2-01M	A22L-D□-T2-01A		
		100 VAC	A22L-D□-T1-11M	A22L-D□-T1-11A		
	SPST-NO + SPST-NO	200 VAC	A22L-D□-T2-11M	A22L-D□-T2-11A		
		100 VAC	A22L-D□-T1-20M	A22L-D□-T1-20A		
	SPST-NC + SPST-NC	200 VAC	A22L-D□-T2-20M	A22L-D□-T2-20A		
		100 VAC	A22L-D□-T1-02M	A22L-D□-T1-02A		
			200 VAC	A22L-D□-T2-02M	A22L-D□-T2-02A	

Note: The contact ratings are for standard loads.

Individual models: Refer to pages 7 to 9.  
 (The Pushbutton, Lamp, and Switch can be ordered separately.)

■ Specifications and dimensions: See pages 13 to 16.  
 ■ Accessories and tools: See pages 10 to 12.

## Ordering Information

**Subassembled** ..... The Pushbutton, Lamp, or Switch can be ordered separately. Use them in combination for models that are not available as assembled Units. These can also be used as inventory for maintenance parts.

### Non-lighted Models

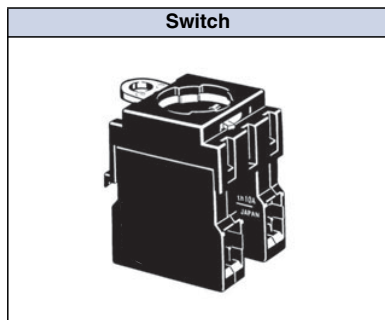
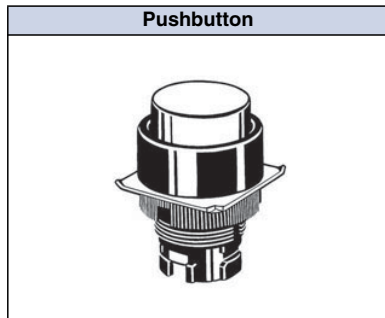

### Lighted Models (without Voltage Reduction Unit)

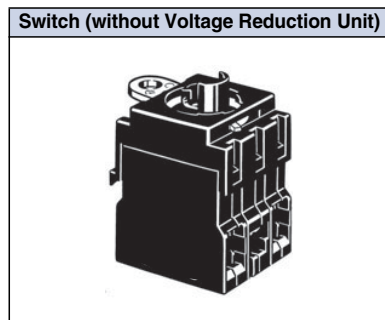
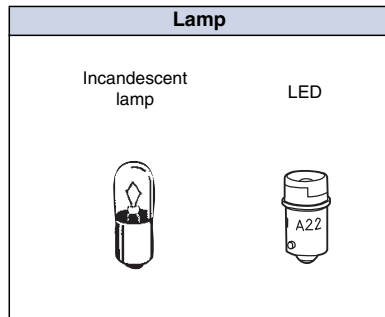
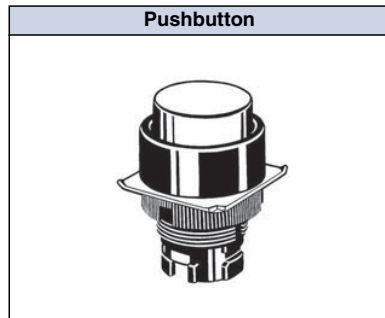

### Lighted Models (with Voltage Reduction Unit)

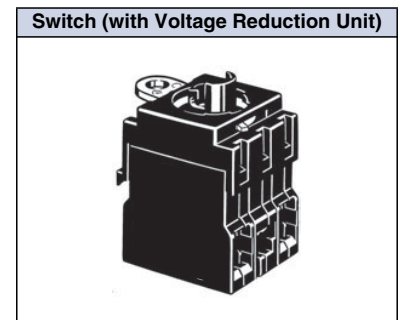
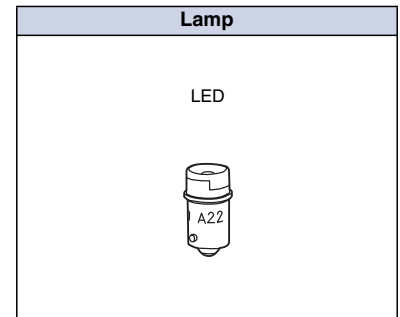
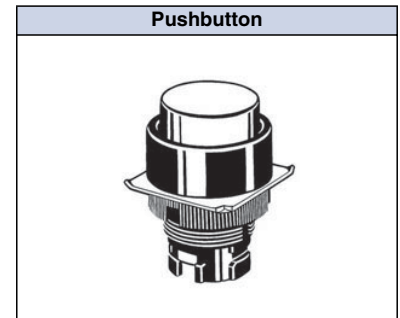



Ordering set combinations: Refer to pages 3 to 6.

- Specifications and dimensions: See pages 13 to 16.
- Accessories and tools: See pages 10 to 12.

## Ordering Information

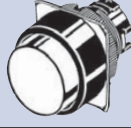

**Subassembled**..... The Pushbutton, Lamp, or Switch can be ordered separately. Use them in combination for models that are not available as assembled Units. These can also be used as inventory for maintenance parts.

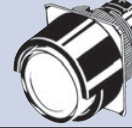
### Pushbutton Non-lighted

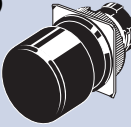
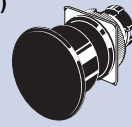
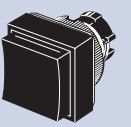
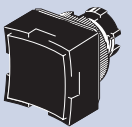
Sealing	IP65 oil-resistant models			
	Flat type	Projection type	Full-guard type	Half-guard type
Appearance				
Color	Model	Model	Model	Model
Red	A22-FR	A22-TR	A22-GR	A22-HR
Green	A22-FG	A22-TG	A22-GG	A22-HG
Yellow	A22-FY	A22-TY	A22-GY	A22-HY
White	A22-FW	A22-TW	A22-GW	A22-HW
Blue	A22-FA	A22-TA	A22-GA	A22-HA
Black	A22-FB	A22-TB	A22-GB	A22-HB

Sealing	IP65 oil-resistant models			
	Round/Mushroom type (30-dia. head)	Round/Mushroom type (40-dia. head)	Square/Projection type	Square/Full-guard type
Appearance				
Color	Model	Model	Model	Model
Red	A22-SR	A22-MR	A22-CR	A22-DR
Green	A22-SG	A22-MG	A22-CG	A22-DG
Yellow	A22-SY	A22-MY	A22-CY	A22-DY
White	A22-SW	A22-MW	A22-CW	A22-DW
Blue	A22-SA	A22-MA	A22-CA	A22-DA
Black	A22-SB	A22-MB	A22-CB	A22-DB

### Lighted

Sealing	IP65		
	Projection type	Full-guard type	Half-guard type
Appearance			
Color	Model	Model	Model
Red	A22L-TR	A22L-GR	A22L-HR
Green	A22L-TG	A22L-GG	A22L-HG
Yellow	A22L-TY	A22L-GY	A22L-HY
White	A22L-TW	A22L-GW	A22L-HW
Blue	A22L-TA	A22L-GA	A22L-HA

Note: Common to incandescent lamps and LED lamps.

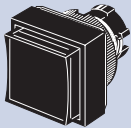
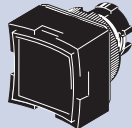
Sealing	IP65	
	Square/Projection type	Square/Full-guard type
Appearance		
Color	Model	Model
Red	A22L-CR	A22L-DR
Green	A22L-CG	A22L-DG
Yellow	A22L-CY	A22L-DY
White	A22L-CW	A22L-DW
Blue	A22L-CA	A22L-DA

Ordering set combinations: Refer to pages 3 to 6.

- Specifications and dimensions: See pages 13 to 16.
- Accessories and tools: See pages 10 to 12.



## Ordering Information

**Subassembled** ..... The Pushbutton, Lamp, or Switch can be ordered separately. Use them in combination for models that are not available as assembled Units. These can also be used as inventory for maintenance parts.

### Lamp LED Lamp

Appearance	Operating voltage	6 V	12 V	24 V	
		LED light	Model	Model	Model
	AC and DC	Red	A22-6AR	---	---
		Green	A22-6AG	---	---
		Yellow *2	A22-6AY	---	---
		Blue	A22-6AA	---	---
		Red	---	A22-12AR	A22-24AR
		Green	---	A22-12AG	A22-24AG
		Yellow *2	---	A22-12AY	A22-24AY
		Blue	---	A22-12AA	A22-24AA

\*1. For voltage-reduction lighting, use the A22-24A□. Only 24-V LED lamps can be used.

\*2. Used when the Pushbutton color is yellow or white.

### Incandescent Lamp

Appearance	Operating voltage	5 VAC/VDC	12 VAC/VDC	24 VAC/VDC
			A22-5	A22-12

### Switch (Standard Load) No Voltage Reduction Unit

Classification	Appearance	Non-lighted		Lighted	
		Operation		Operation	
		Momentary	Alternate	Momentary	Alternate
Contacts		Model	Model	Model	Model
Standard load	SPST-NO	A22-10M	A22-10A	A22L-10M	A22L-10A
	SPST-NC	A22-01M	A22-01A	A22L-01M	A22L-01A
	SPST-NO + SPST-NC	A22-11M	A22-11A	A22L-11M	A22L-11A
	SPST-NO + SPST-NO	A22-20M	A22-20A	A22L-20M	A22L-20A
	SPST-NC + SPST-NC	A22-02M	A22-02A	A22L-02M	A22L-02A

### Voltage Reduction Unit

Classification	Appearance	110 VAC, Lighted		220 VAC, Lighted	
		Operation		Operation	
		Momentary	Alternate	Momentary	Alternate
Contacts		Model	Model	Model	Model
Standard load	SPST-NO	A22L-10M-T1	A22L-10A-T1	A22L-10M-T2	A22L-10A-T2
	SPST-NC	A22L-01M-T1	A22L-01A-T1	A22L-01M-T2	A22L-01A-T2
	SPST-NO + SPST-NC	A22L-11M-T1	A22L-11A-T1	A22L-11M-T2	A22L-11A-T2
	SPST-NO + SPST-NO	A22L-20M-T1	A22L-20A-T1	A22L-20M-T2	A22L-20A-T2
	SPST-NC + SPST-NC	A22L-02M-T1	A22L-02A-T1	A22L-02M-T2	A22L-02A-T2

\*1. A DPST-NO model is shown here as an example.















\*2. For a model with a Voltage Reduction Unit, use the A22-24A□. Only 24-V LED lamps can be used.

Ordering set combinations: Refer to pages 3 to 6.





- Specifications and dimensions: See pages 13 to 16.
- Accessories and tools: See pages 10 to 12.

## Ordering Information

### Accessories (Order Separately) Accessories

Item		Appearance	Classification		Model	Remarks
Switch Blocks			SPST-NO	Standard load	<b>A22-10</b>	Order Switch Blocks to add an SPST-NO (A22-10) or SPST-NC (A22-01) Switch Block (for standard loads) or to replace a Switch Block.
				Microload	<b>A22-10S</b>	
			SPST-NC	Standard load	<b>A22-01</b>	
				Microload	<b>A22-01S</b>	
			DPST-NO	Standard load	<b>A22-20</b>	
				Microload	<b>A22-20S</b>	
			DPST-NC	Standard load	<b>A22-02</b>	
SPST-NO + SPST-NC	Microload	<b>A22-02S</b>				
	Standard load	<b>A22-11</b>				
Microload	<b>A22-11S</b>					
Lamp Sockets		Direct lighting		<b>A22-TN</b>	Used when changing the lighting method. (LED only)	
		Voltage-reduction lighting	110 VAC	<b>A22-T1</b>		
			220 VAC	<b>A22-T2</b>		
Mounting Latches		For momentary models		<b>A22-3200</b>	Provided as standard. Order Mounting Latches only when mounting Switch Blocks or Lamp Sockets that are purchased individually.	
		For alternate models		<b>A22-3210</b>		
Legend Plate Frames	Standard size		With Snap-in Legend Plate (Without text)	White	<b>A22Z-3321</b>	Snap-in Legend Plate is acrylic.
				Red	<b>A22Z-3322</b>	
			Black	<b>A22Z-3323</b>		
			Without Snap-in Legend Plate		<b>A22Z-3320</b>	
	Large size		With Snap-in Legend Plate (Without text)	White	<b>A22Z-3331</b>	Snap-in Legend Plate is acrylic.
				Red	<b>A22Z-3332</b>	
Black			<b>A22Z-3333</b>			
Without Snap-in Legend Plate			<b>A22Z-3330</b>			
Lock Ring		Round	<b>A22Z-3360</b>	This Lock Ring is used when a more secure lock feature is required.		
Metallic Bezel Rings		For flat or projection models		<b>A22Z-3580</b>	Replace with the standard model. Material: Copper alloy-Nickel chrome plating Cannot be used with the M22.	
		For full-guard models		<b>A22Z-3582</b>		
Sealing Caps		For flat models		<b>A22Z-3600F</b>	Used to prevent dust or water from entering the Operation Unit (Pushbutton, etc.). Color: opaque Material: silicon	
		For projection models		<b>A22Z-3600T</b>		
		For full-guard models		<b>A22Z-3600G</b>		
Color Caps		Red	<b>A22Z-30TR</b>	Used for changing the Pushbutton color of the (round) Pushbutton Switches. Cannot be used, however, with Half-guard Switches.		
		Green	<b>A22Z-30TG</b>			
		Yellow	<b>A22Z-30TY</b>			
		White	<b>A22Z-30TW</b>			
		Blue	<b>A22Z-30TA</b>			
Caps	For A22		For projection, full-guard, or half-guard models	<b>A22Z-3490</b>	Material: polycarbonate resin	
	For M22		For round models	<b>A22Z-3495</b>		
Three-throw Spacer		---	<b>A22Z-3003</b>	Used when mounting three Nonlighted Switches. Cannot be used with Alternate action type, knob-type Selector, and Key-type Selector because of the structure. Mushroom-type Switch provides an A22Z-3003, three-throw spacer. (See page 28.)		
Hole Plug		Round	<b>A22Z-3530</b>	Can be plugged into pre-cut panel holes for future expansion. The color is black. Color: Black		
Control Boxes (Enclosures)		One hole	<b>A22Z-B101</b>	For those designed A22Z-B1□, DPST-NO or DPST-NC Switches cannot be used. A22Z-B2□ Control Boxes, A22-series alternate operation models, and DPST-NO, DPST-NC, and SPST-NO + SPST-NC contacts cannot be used. Material: Polycarbonate resin		
		One hole, yellow box (for emergency stop)	<b>A22Z-B201</b>			
			<b>A22Z-B201Y</b>			
		Two holes	<b>A22Z-B102</b>			
		Three holes	<b>A22Z-B202</b>			
	<b>A22Z-B103</b>					
	<b>A22Z-B203</b>					
Connectors		Applicable cable diameter (mm)	7 to 9 dia.	<b>A22Z-3500-1</b>	Plastic connector used to extend a cable from the Switch Box. (See 9 to 11 dia. A22Z-3500-2 page 27.)	
			9 to 11 dia.	<b>A22Z-3500-2</b>		

## Ordering Information

Item	Appearance	Classification	Model	Remarks
25-dia. Ring		---	<b>A22Z-R25</b>	Use when mounting to a panel with a 25-dia. hole. For details, refer to page 18. Since this is not attached to the main body, order separately.
30-dia. Resin Attachment		Round	<b>A22Z-A30</b>	Use when mounting to a panel with a 30-dia. hole. For details, refer to page 20.
Lock Plate		---	<b>A22Z-3380</b>	Use to fix the lever on the Switch.
Simple Protective Cover		---	<b>A22Z-3700</b>	Prevents foreign matter entering into the Switch from the back of the panel.



■ Specifications: See pages 13 to 14.

■ Dimensions: See page 16.

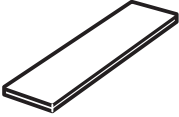
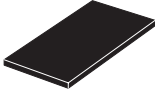

■ Precautions for correct use: See page 23.

■ Accessories and tools: See pages 10 to 12.

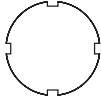
## Ordering Information

Item	Appearance	Classification	Model	Remarks		
Snap-in Legend Plates		Without text	Black	A22Z443B	Attached to the Standard-size Legend Plate Frame. (See page 28.) Material: Acrylic	
			Red	A22Z443R		
			White	A22Z443W		
			Transparent	A22Z443C		
		With text	White text on red background	○		A22Z443R-2
				STOP		A22Z443R-4
				STOP		A22Z443R-4
			Black text on red background	EMERGENCY STOP		A22Z443R-J
						A22Z443B-1
				START		A22Z443B-3
				ON		A22Z443B-5
				OFF		A22Z443B-6
				UP		A22Z443B-7
				DOWN		A22Z443B-8
				POWER ON		A22Z443B-9
				OFF-ON		A22Z443B-10
				AUTO		A22Z443B-J
				MANUAL		A22Z443B-2
				START		A22Z443B-3
				RESET		A22Z443B-4
				ON		A22Z443B-5
				OFF		A22Z443B-6
				POWER ON		A22Z443B-7
				RUN		A22Z443B-8
				UP		A22Z443B-9
DOWN	A22Z443B-10					
OFF-ON	A22Z443B-11					
MANUAL-AUTO	A22Z443B-12					
REVERSE-FORWARD	A22Z443B-13					
CLOSE-OPEN	A22Z443B-14					
MANUAL OFF AUTO	A22Z443B-15					
Large size		Without text	Black	A22Z45B	Used as an Emergency Stop Switch Legend Plate. (See page 28.) Material: Acrylic	
			Red	A22Z45R		
			White	A22Z45W		
			Transparent	A22Z45C		
For Emergency Stop Switch		Black text on yellow background	60-dia. round plate with black letters on a yellow background	A22Z46I	EMERGENCY STOP is engraved on the plate. Used as an Emergency Stop Switch Legend Plate	
			90-dia. round plate with black letters on a yellow background	A22Z46II		
Character Films		No print (Round)	A22Z46	After printing on a film, affix to the indicator plate of the Lighted Pushbutton Switch. (The back is coated with adhesive.)		
		Character print (Round)	○		A22Z46I	
			START		A22Z46II	
			STOP		A22Z46III	
		No print (Square)	A22Z46			

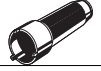
### Tools

Item	Appearance	Classification	Model	Remarks
Lamp Extractor		---	A22Z30	Rubber tool used to easily replace Lamps
Tightening Wrench		---	A22Z30	Used to tighten mounting nuts from the back of the panel and to replace the cap of the Lighted Emergency Switch.
Cap Tightening Tool		---	A22Z30	Used for replacing the cap of the Half-guard Pushbutton Switch.
Cap Puller		---	A3P-B	Used for removing the cap from the Pushbutton of the Square Lighted Pushbutton Switch.

■ Specifications: See pages 13 to 14.

■ Dimensions: See page 16.

■ Precautions for correct use: See page 23.

■ Accessories and tools: See pages 10 to 12.

## Specifications

### Approved Standard Ratings

#### UL (File No. E4155)

6 A at 220 VAC, 10 A at 110 VAC

Note: Only Switch Blocks and Lamp Sockets are recognized by UL.  
Refer to Page 10 for the model numbers.

#### EN60751 (Low Voltage Directive)

3 A at 220 VAC

#### CCC (GB1405)

3 A at 240 VAC, 1.5 A at 24 VDC

## Ratings

### Contacts (Standard Load)

Contacts (Standard Load)	Rated voltage	Rated current (A)					
		Induc- tive load	Resis- tive load	Induc- tive load	Resis- tive load		
10A	24 VAC	10	10	---	---		
	110 VAC	5	10				
	220 VAC	3	6				
	380 VAC	2	3				
	440 VAC	1	2	---	---		
	24 VDC	---	---			1.5	10
	110 VDC					0.5	2
	220 VDC					0.2	0.6
380 VDC	0.1			0.2			

Note: 1. The above ratings were obtained by conducting tests under the following conditions.

- (1) Ambient temperature: 20±2°C
  - (2) Ambient humidity: 65±5% RH
  - (3) Operating frequency: 20 operations/minute
2. Minimum applicable load: 10 mA at 5 VDC

### Contacts (Microload)

Rated applicable load	50 mA at 24 VDC (Resistive load)
Minimum applicable load	1 mA at 5 VDC

### LED Indicators

Rated voltage	Rated current	Operating voltage
6 VAC/VDC	8 mA	6 VAC/VDC±5%
12 VAC/VDC		12 VAC/VDC±5%
24 VAC/VDC		24 VAC/VDC±5%

### Incandescent Lamp

Rated voltage	Rated current	Operating voltage
6 VAC/VDC	200 mA	5 V
14 VAC/VDC	80 mA	12 V
28 VAC/VDC	40 mA	24 V

### Voltage-reduction Lighting

Rated voltage	Rated current	Operating voltage	Applicable lamp (BAS/Base: 13)
110 VAC	8 mA	100 VAC (95 to 115 V)	LED Lamp (A22-24A□)
220 VAC		200 VAC (190 to 230 V)	

## Specifications

### Characteristics

Type		Pushbutton Switches		Knob-type Selector Switches		Key-type Selector Switch	Indicator
		Non-lighted models: A22-F A22-T A22-G A22-H A22-S A22-M A22-C A22-D	Lighted models: A22L-T A22L-G A22L-H A22L-C A22L-D	Non-lighted model: A22S	Lighted model: A22W	Non-lighted model: A22K	M22
Allowable operating frequency	Mechanical	Momentary operation: 60 operations/minute max.		Manual reset: 30 operations/minute max. Automatic reset: 30 operations/minute max.		---	
	Electrical	30 operations/minute max.					---
Insulation resistance		100 MΩ min. (at 500 VDC)					
Dielectric strength	Between terminals of same polarity	2,500VAC, 50/60Hz for 1min					
	Between each terminal and ground	2,500VAC, 50/60Hz for 1min					
Vibration resistance	Malfunction *1	Malfunction *2: 10 to 55 Hz, 1.5-mm double amplitude					
Shock resistance	Destruction	1,000 m/s <sup>2</sup>	1,000 m/s <sup>2</sup>	1,000 m/s <sup>2</sup>	1,000 m/s <sup>2</sup>	1,000 m/s <sup>2</sup>	1,000 m/s <sup>2</sup>
	Malfunction *1	1,000 m/s <sup>2</sup> max.	600 m/s <sup>2</sup> max.	1,000 m/s <sup>2</sup> max.	600 m/s <sup>2</sup> max.	1000 m/s <sup>2</sup> max.	600 m/s <sup>2</sup> max.
Durability	Mechanical	Momentary operation: 5,000,000 operations min.		500,000 operations min.	100,000 operations min.	500,000 operations min.	---
	Electrical	500,000 operations min.		500,000 operations min.	100,000 operations min.	500,000 operations min.	---
Ambient operating temperature *2		-20°C to 70°C	-20°C to 55°C	-20°C to 70°C	-20°C to 55°C	-20°C to 70°C	-20°C to 55°C
Ambient operating humidity		35% to 85% RH					
Ambient storage temperature *2		-40°C to 70°C					
Degree of protection *3		IP65 (oil-resistant)	IP65	IP65 (oil-resistant)	IP65	IP65 (oil-resistant)	IP65
Electric shock protection class		Class II					
PTI (tracking characteristic)		175					
Degree of contamination		3 (IEC947-5-1)					

\*1. Malfunction within 1 ms.

\*2. With no icing or condensation.

\*3. Degree of protection from the front of the panel.

### Operating Characteristics (for SPST-NO/SPST-NC)

Item	Type	Pushbutton Switches	Knob-type Selector		Key-type Selector Switch	
		Lighted Nonlighted Pushbutton Switches	Manual reset	Automatic reset	Manual reset	Automatic reset
		A22-F A22-T A22-G A22-H A22-C A22-D A22-S A22-M A22L-T A22L-G A22L-H A22L-C A22L-D	A22S A22W		A22K	
Total travel force (TTF) max.	29.4 N	0.34 N-m*	0.25 N-m for two notches * 0.34 N-m for three notches *	0.34 N-m*	0.25 N-m for two notches * 0.34 N-m for three notches *	
Total travel (TT)	5.5 mm max.	Approx. 90° for two notches (Approx. 45° for three notches)		Approx. 90° for two notches (Approx. 45° for three notches)		
Resetting force (RF) min.	---	0.34 N-m max.*	---	0.34 N-m max.*	---	

\* Rotation torque for Knob-type Selector and Key-type Selector Switches.

## Nomenclature

### Model Structure

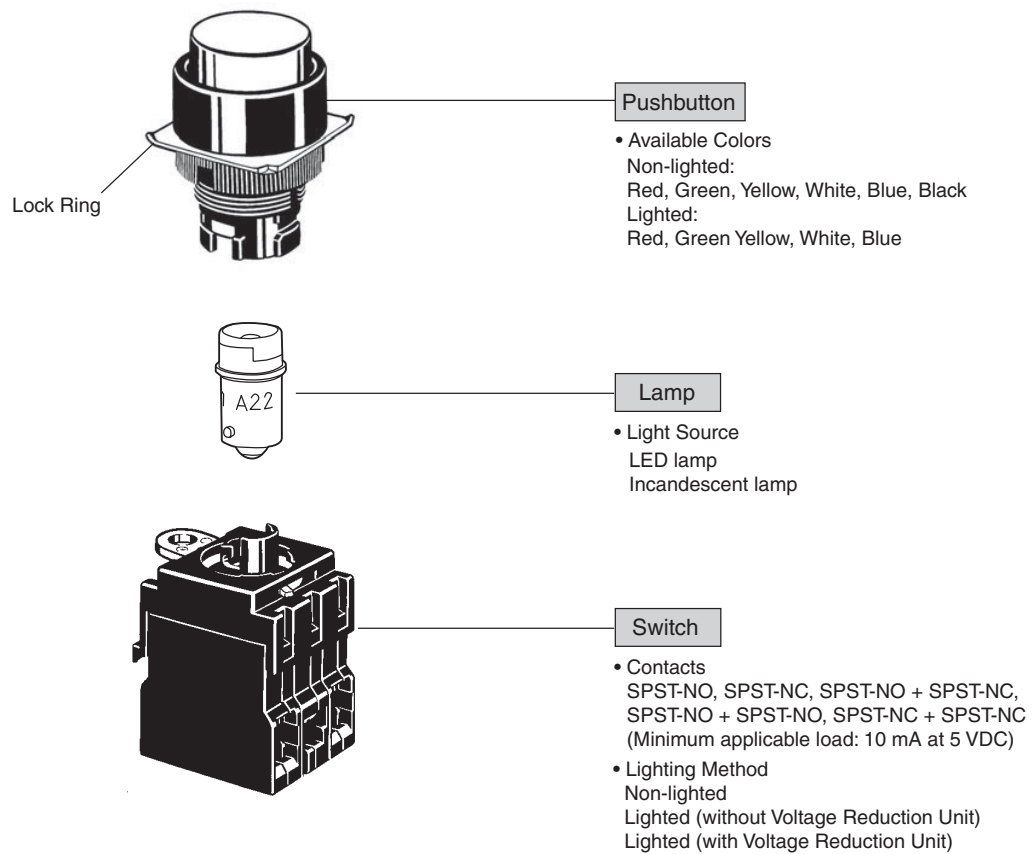

The above illustration shows a lighted model.

## Dimensions

Lighted/Non-lighted Pushbutton Switches (The following illustrations are for momentary operation.)

### Flat Type/A22-F

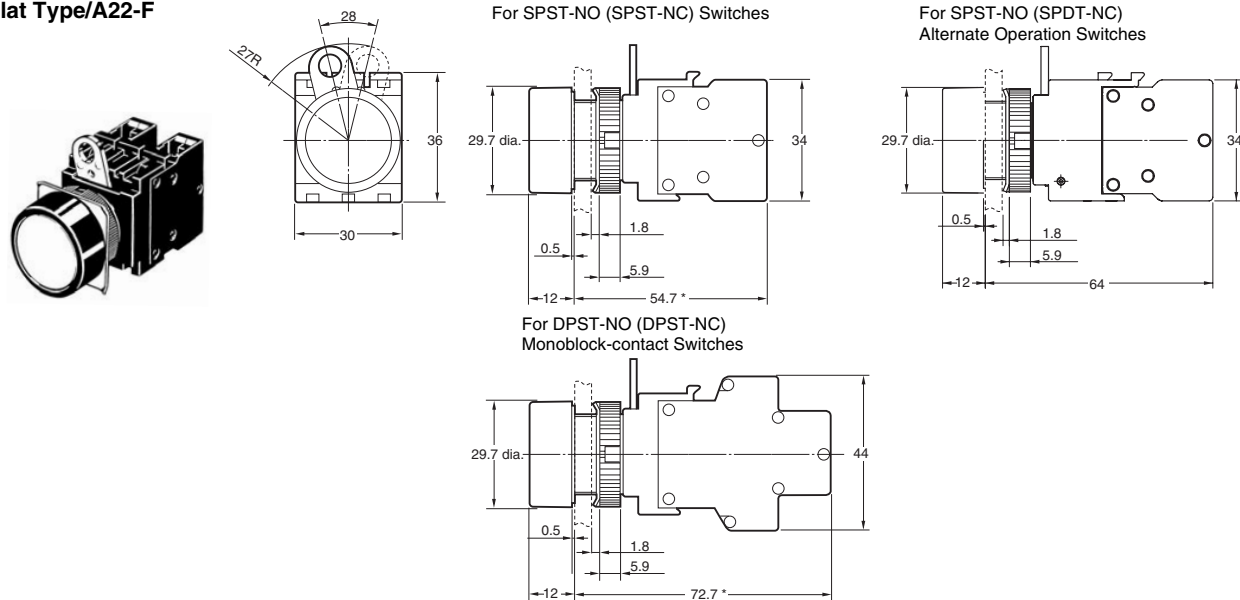

### Half-guard Type/A22-H/A22L-H

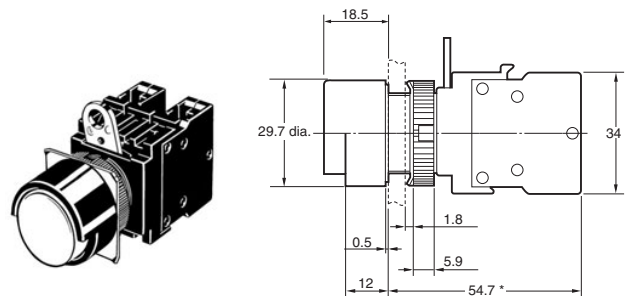

### Projection Type/A22-T/A22L-T

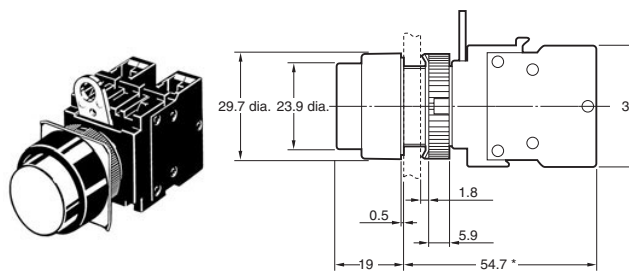

### Full-guard Type/A22-G/A22L-G

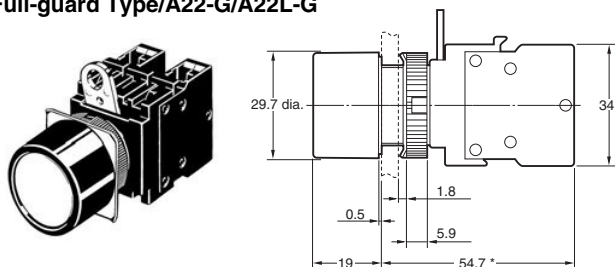

### 40-dia. Mushroom Type/A22-M

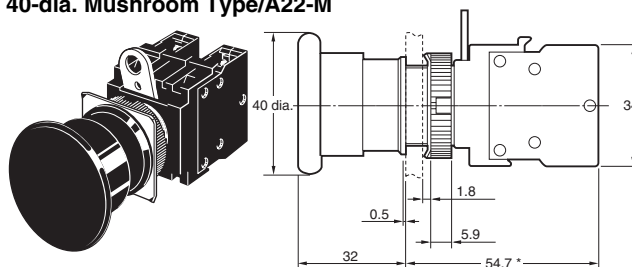

### Square/Projection type/A22-C/A22L-C

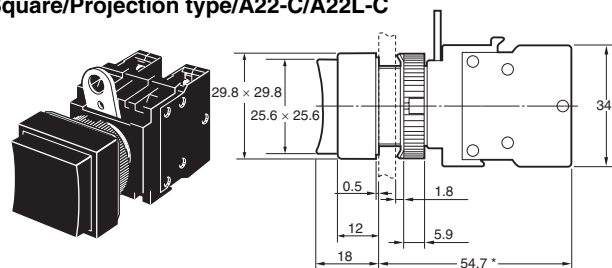

### Square/Full-guard Type/A22-D/A22L-D

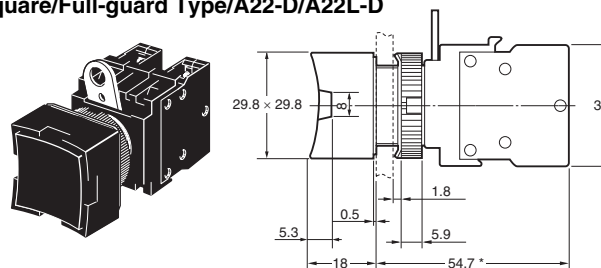

Note: Lighted models have the same dimensions as shown above, whether they are with or without Voltage Reduction Units.  
\* Alternate operation models are 9.3 mm longer.



Dimensions

Terminal Arrangement (Bottom View)

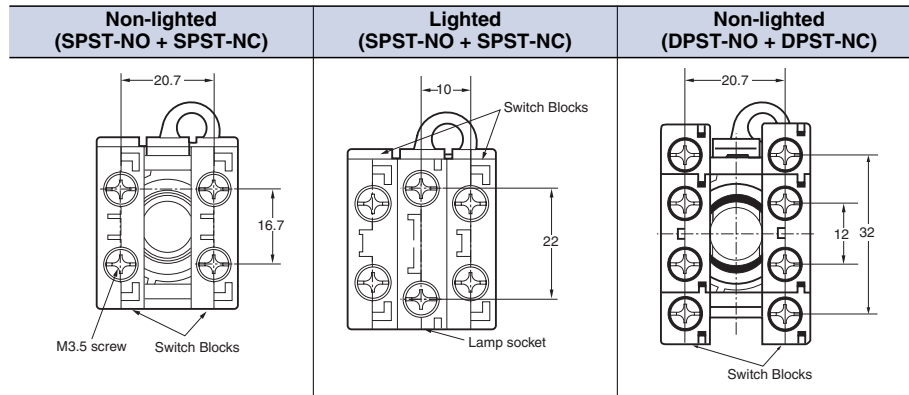

Terminal Connection

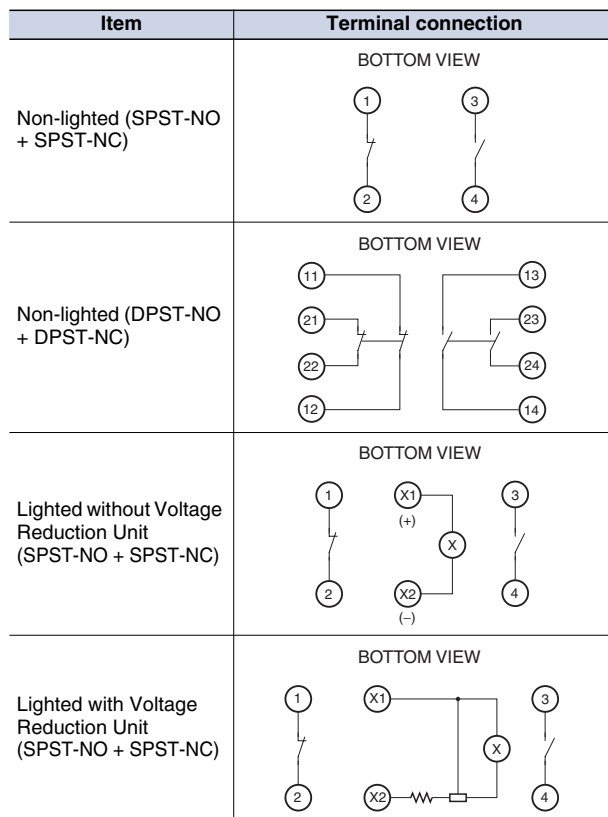

Panel Cutouts

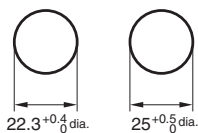

Lock ring is provided as a standard item.

- When applying coating such as paint to the panel, the dimensions should be those after the application of coating.
- Recommended panel thickness: 1 to 5 mm.
- Use an A22Z-R25 Ring when mounting to a panel with 25-mm holes.

## Dimensions

### Accessories

#### Legend Plate Frames

##### Standard Models A22Z-332

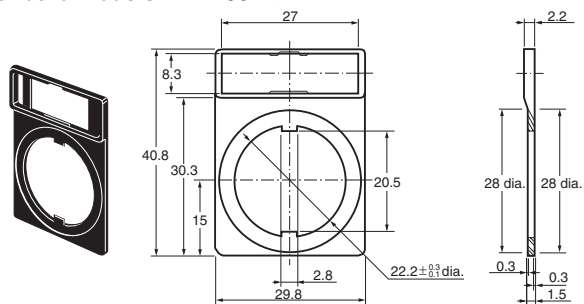

##### Large A22Z-333

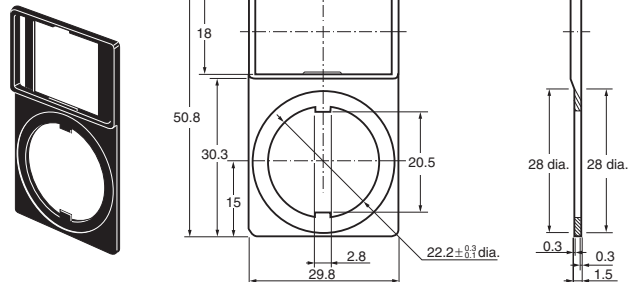

#### Lamp

##### LED A22-6, 12, 24

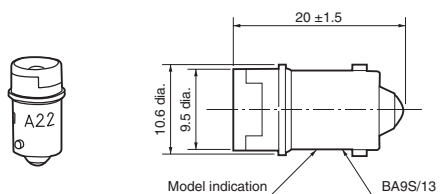

##### Incandescent lamp A22-5, 12, 24

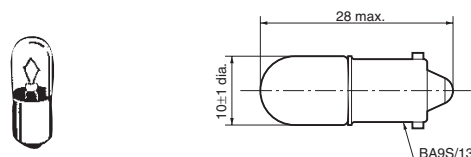

##### Lock Ring A22Z-3360

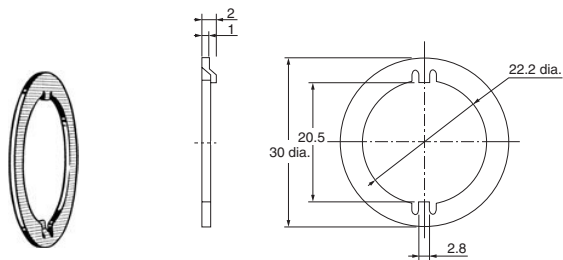

##### 25-dia. Ring A22Z-R25

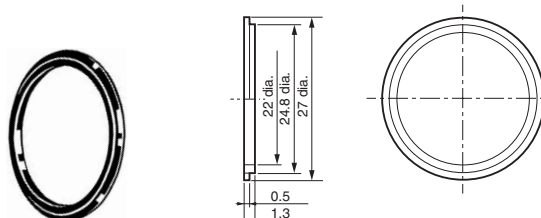

##### Color Cap A22Z-30T

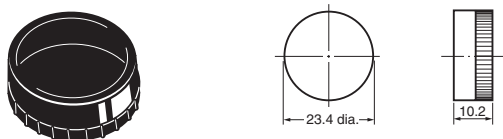

##### Hole Plug (Round) A22Z-3530

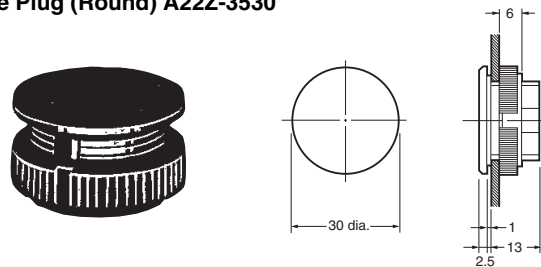

#### Caps

##### A22 (for round models) A22Z-3490

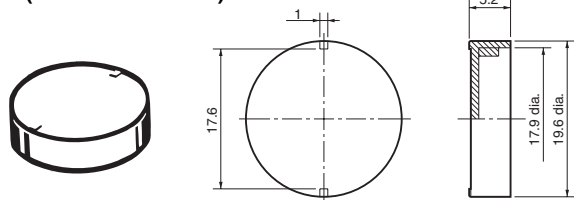

##### M22 (for round models) A22Z-3495

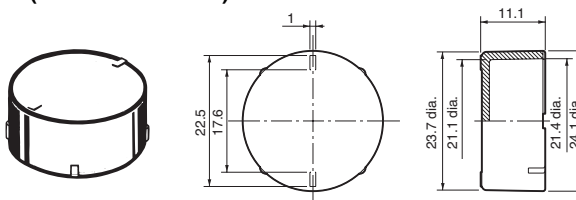

Dimensions

Sealing Caps

For Flat Models A22Z-3600F

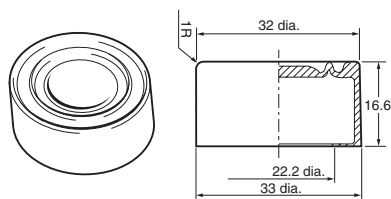

For projection models A22Z-3600T

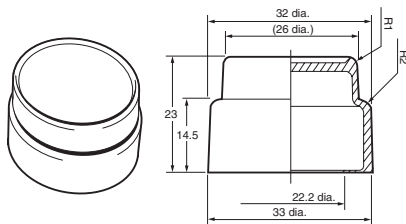

For full-guard models A22Z-3600G

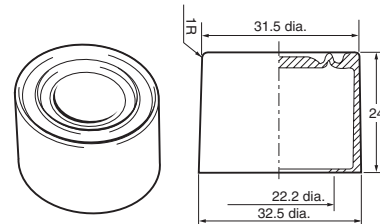

Metallic Bezel Rings

For Flat/Projection Models A22Z-3580

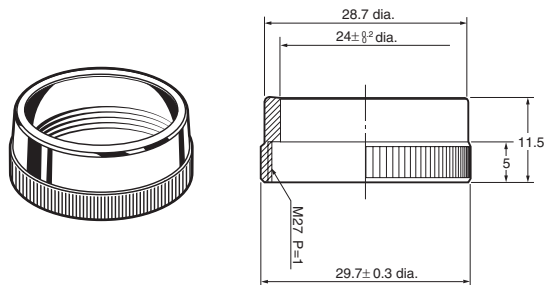

For full-guard models A22Z-3582

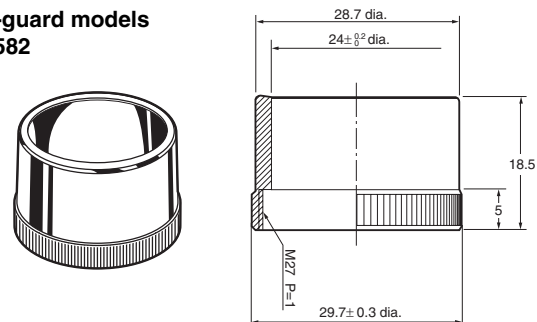

Snap-in Legend Plates

For Standard Models A22Z-3443 □-□

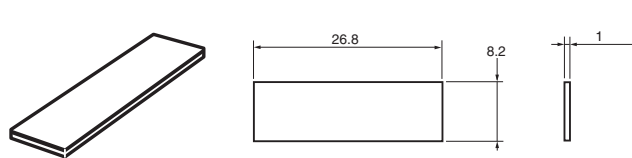

For Large Models A22Z-3453 □

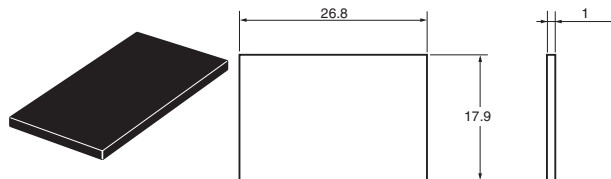

For Emergency-stop Models

A22Z-3476-1 (90 dia.)

A22Z-3466-1 (60 dia.)

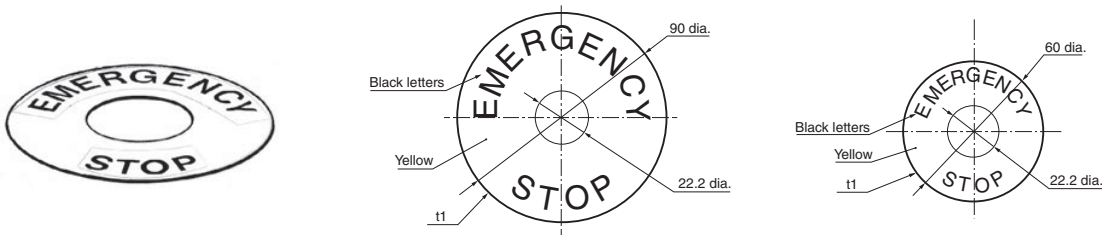

Character Film

For Round Models A22Z-3460-□

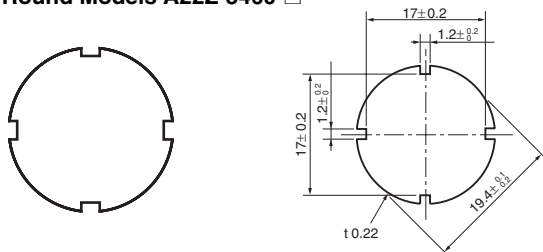

For Square Models A22Z-3480

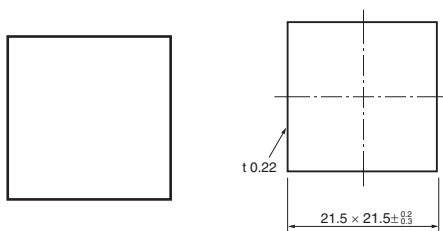

Dimensions

Lamp Extractor A22Z-3901

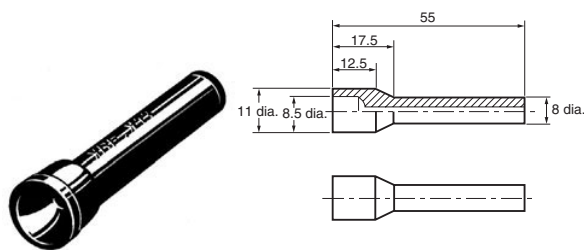

Tightening Wrench A22Z-3905

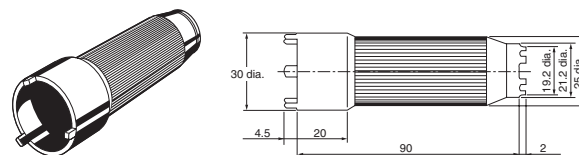

Cap Tightening Tool A22Z-3908

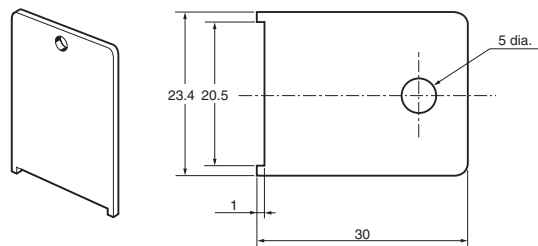

30-dia. Resin Attachment A22Z-A30

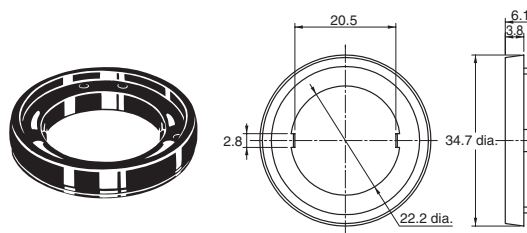

Cap Puller A3PJ-5080

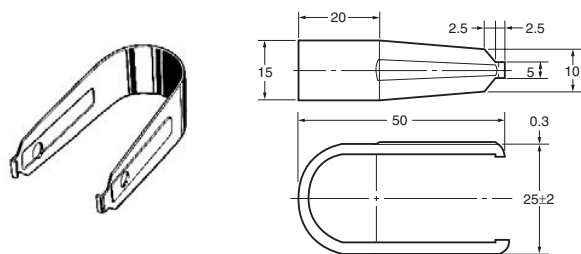

Lock Plate A22Z-3380

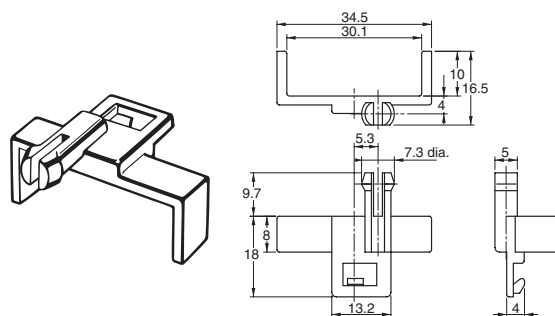

Simple Protective Cover A22Z-3700

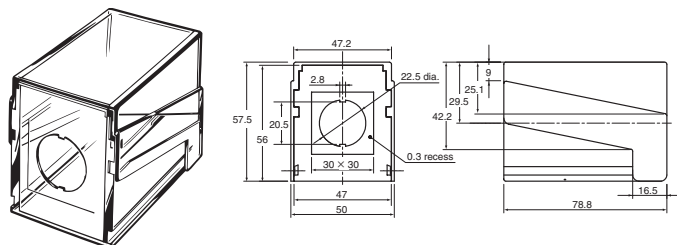

Three-throw Spacer A22Z-3003

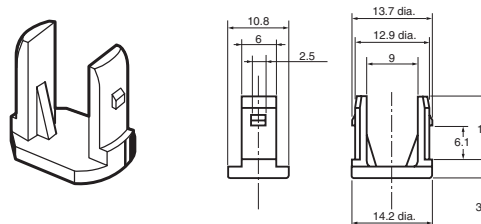

Dimensions

Control Box (Enclosure) A22Z-B10□

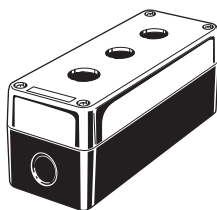

A22Z-B101 (One Hole)  
A22Z-B101Y

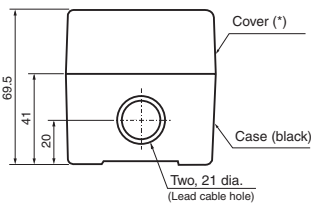
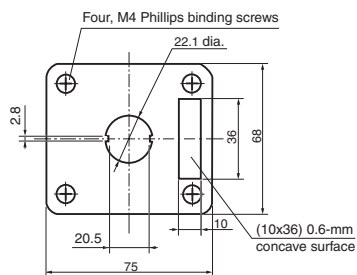

\* A22Z-B101: gray  
A22Z-B101Y: yellow

Cable Port Hole (Top View)

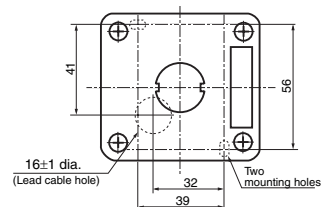

A22Z-B102 (Two Holes)

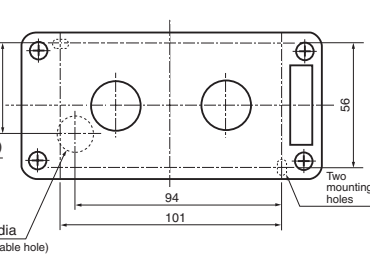
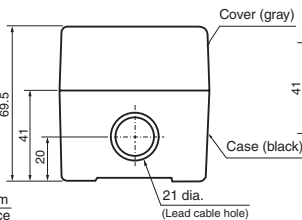
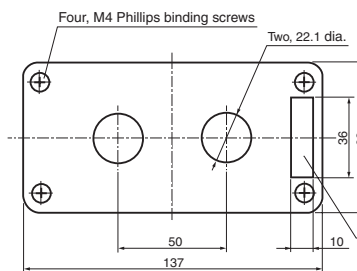

A22Z-B103 (Three Holes)

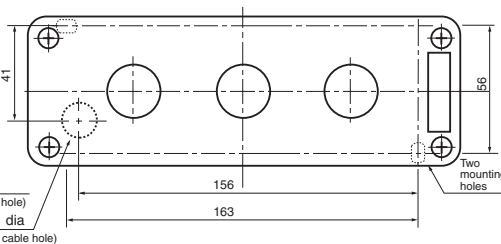
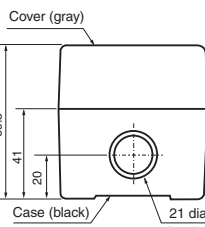
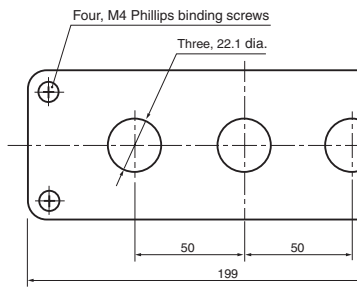

(Panel Mounting Hole)

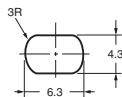

## Dimensions

### Control Box A22Z-B20

#### A22Z-B201 (One Hole)

#### A22Z-B201Y

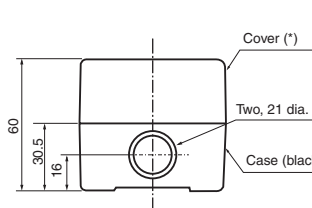
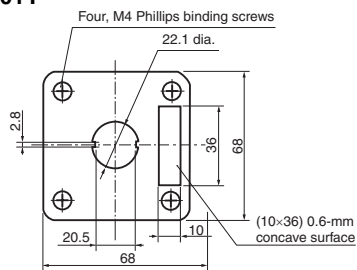

#### Cable Port Hole (Top View)

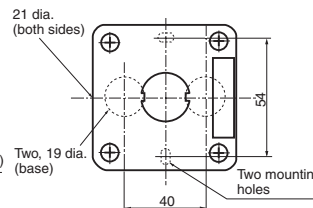

\* A22Z-B201: gray  
A22Z-B201Y: yellow

### A22Z-B202 (Two Holes)

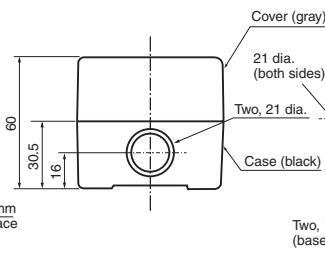
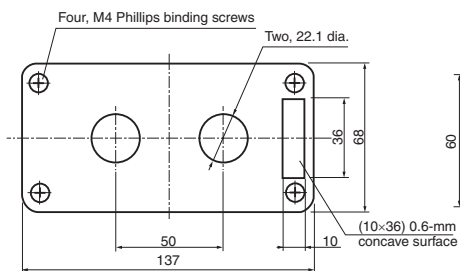

#### Cable Port Hole (Top View)

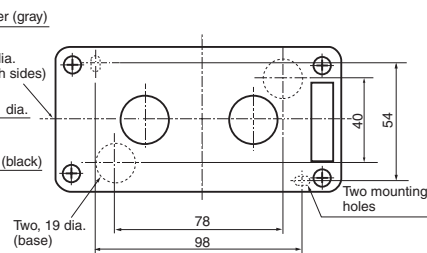

### A22Z-B203 (Three Holes)

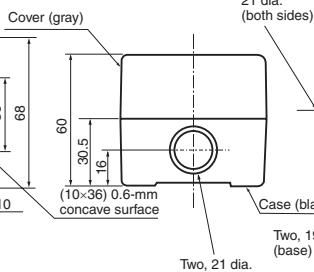
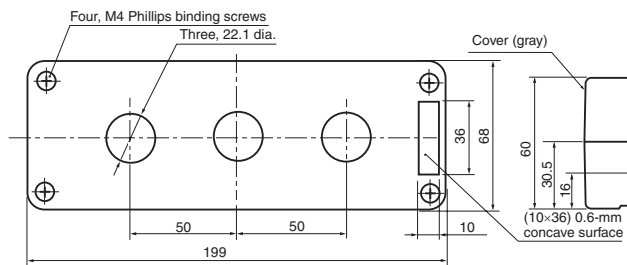

#### Cable Port Hole (Top View)

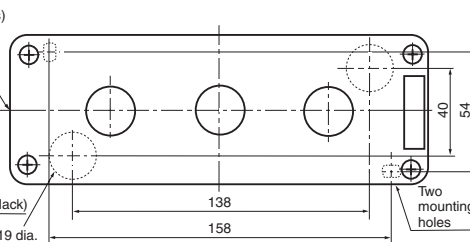

### (Panel Mounting Hole)

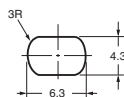

## Safety Precautions

Refer to *Safety Precautions for All Pushbutton Switches*.

### WARNING

Do not apply a voltage between the incandescent lamp and the terminal that is greater than the rated voltage. If the incandescent lamp is broken, the Operation Units may pop out. Always turn OFF the power and wait for 10 minutes before replacing the incandescent lamp. If the lamp is replaced immediately after the power is turned OFF, the remaining heat may cause burns.



### Precautions for Correct Use

#### Mounting

- Do not perform wiring with power supplied to the Switch. Do not touch the terminals or other charged parts of the Switch while power is being supplied. Doing so may result in electric shock.
- Always make sure that the power is turned OFF before mounting, removing, or wiring the Switch, or performing maintenance. Do not tighten the mounting ring more than necessary using tools such as pointed-nose pliers. Doing so will damage the mounting ring. The tightening torque is 0.98 to 1.96 N·m.
- Recommended panel thickness: 1 to 5 mm.
- When mounting the caps after changing the LED or the caps, tighten the caps at a tightening torque of 0.49 to 0.78 N·m.

#### Wiring

- Terminal screws must be Phillips or slotted M3.5 screws with a square washer.
- The tightening torque is 1.08 to 1.27 N·m.
- Solid wires, stranded wires, and crimp terminals can be connected to the Switch.

#### Applicable Wire Size

Stranded wire: 2 mm<sup>2</sup> max.

Solid wire: 1.6 dia. max.

Bare Crimp Terminals

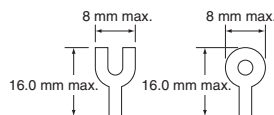

Crimp Terminals with Insulating Sheath

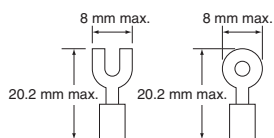

- After wiring the Switch, maintain an appropriate clearance and creepage distance.

#### Operating Environment

- The IP65 model is designed with a degree of protection so that it will not sustain damage if it is subjected to water from any direction to the front of the panel.
- This switch is intended for indoor use only. Using the Switch outdoors will result in failure.

#### LED

- The LED current-limiting resistor is built-in, so internal resistance is not required.
- If commercially available LEDs are used, select the ones that meet the following conditions:
  - Base: BA9S/13
  - Overall length: 26 mm max.
  - Power consumption: 2.6 W max.
  - When DC-specific LEDs are used, wire the Switch so that the X1 terminal is positive.
- Mis-lighting of the LED
  - The LED lights with approx. 0.1 mA or less of micro-current. Take a countermeasure like adding a resistor to prevent mis-lighting in parallel to the LED.
  - The micro-current varies with the machine (leak current or stray capacity between cables, etc.). Select resistance value and allowable power consumption that meet the actual current.

#### (Circuit example)

In case of using 24 VAC/VDC, Direct lighting

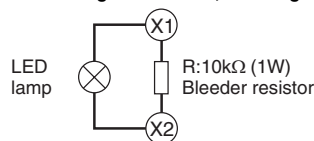

#### Others

- If the panel is to be finished with coating, etc., make sure that the panel meets the specified dimensions after the coating.
- Do not subject the Switch to extreme shock or vibration. Doing so will cause malfunctions and damage to the Switch.

#### Using the Microload

- Insert a contact protection circuit, if necessary, to prevent the reduction of life expectancy due to extreme wear on the contacts caused by loads where inrush current occurs when the contact is opened and closed. The minimum applicable load is the N-level reference value. This value indicates the malfunction reference level for the reliability level of 60% ( $\lambda 60$ ) (conforming to JIS C5003). The equation,  $\lambda 60 = 0.5 \times 10^{-6}/\text{operations}$  indicates that the estimated malfunction rate is less than 1/2,000,000 operations with a reliability level of 60%.

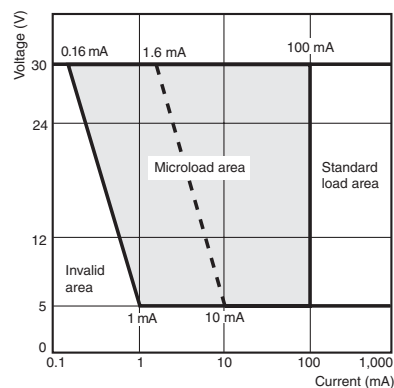

## Application

### Mounting to the Panel

#### Panel Hole Dimensions

- Panel hole dimensions are given below.
- Recommended panel thickness: 1 to 5 mm.

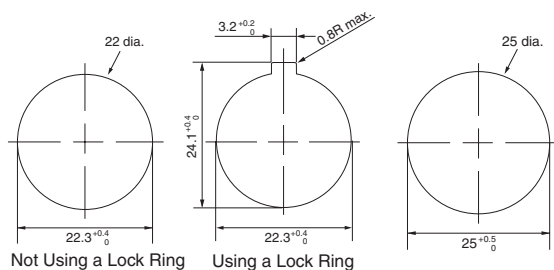

- For 25-dia. holes, always use 25-dia. Rings. (Since the cutout dimensions are large, IP65 cannot be guaranteed unless 25-dia. Rings are used.)
- If outer surface treatment such as coating is performed for the panel, the panel dimensions after outer surface treatment must meet the specified panel dimensions.

#### Matrix Installation

1. The following panel hole dimensions apply when Switch Unit and the Standard-size Legend Plate Frame and Lock Ring are mounted, and lead wires are connected directly to the Switch Block.

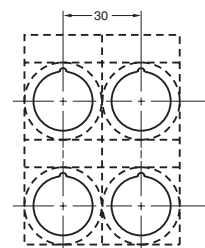

2. The following panel hole dimensions apply when the Large-size Legend Plate Frame is mounted, and when crimp terminals are connected to the Switch Block terminals.

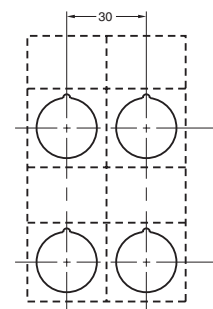

Pitches A and B between the centers of the mounting holes are as follows:

#### For 1. above:

Switch Blocks	A
A22-10, A22-10S A22-01, A22-01S	45 mm min.
A22-20, A22-20S, A22-02 A22-02S, A22-11, A22-11S	55 mm min.

#### For 2. above:

Type of crimp terminal	Switch Blocks	B
Bare crimp terminals	A22-10, A22-10S A22-01, A22-01S	51 mm min.
	A22-20, A22-20S, A22-02 A22-02S, A22-11, A22-11S	61 mm min.
Crimp terminals with insulating sheath	A22-10, A22-10S A22-01, A22-01S	60 mm min.
	A22-20, A22-20S, A22-02 A22-02S, A22-11, A22-11S	70 mm min.

Note: 1. The above dimensions are the minimum dimensions for when the wires described under Applicable Wire Size on page 23 are used. If a different wires are used, the wiring dimensions may be different so determine an appropriate pitch before setup.

2. With pushbuttons of external dimensions greater than 30 mm, set the pitch according to the dimensions. (When using matrix installation for the A22-M□, mount with a pitch of 40 mm instead of 30 mm in the diagram above.)

#### Mounting the Operation Unit on the Panel

- Insert the Operation Unit (Pushbutton, etc.) from the front surface of the panel, insert the Lock Ring and the mounting nut from the terminal side, then tighten the nut. Before tightening, check that the rubber washer is present between the Pushbutton Unit and the panel.
- When using a Legend Plate Frame, put one rubber washer each between the Legend Plate Frame and the panel and between the Operation Unit and the Legend Plate Frame. (One rubber washer will be provided when one Legend Plate Frame is ordered.)
- Align the Lock Ring with the groove in the casing, then insert the Lock Ring so that its edge is located on the panel side.



- Tighten the mounting nut at a torque of 0.98 to 1.96 N-m.
- When using a Lock Ring, replace with the supplied Lock Ring, insert the projecting part into the lock slot, and then tighten the mounting nut.

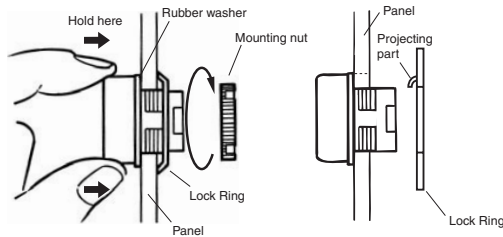

- When the panel cutout dimension is 25 dia., remove the supplied rubber washer and mount the 25-dia. Ring as shown below. (Since the A22Z-R25 is not attached to the main body, order separately.)

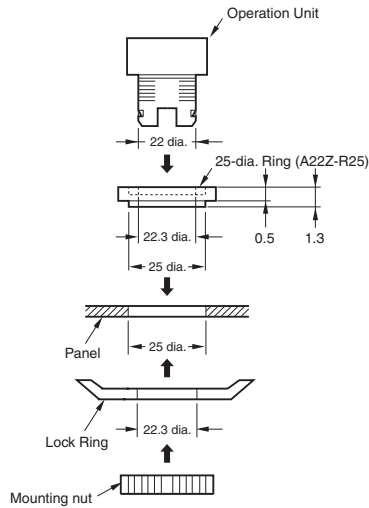

**Mounting the Switch on the Pushbutton Unit**

- Insert the Pushbutton Unit into the Switch Unit, aligning the arrow mark inscribed on the Case with the lever on the Switch Blocks, then move the lever in the direction indicated by the arrow in the following figure.

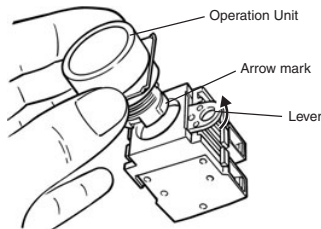

**Removing the Switch**

- Move the lever in the direction indicated by the arrow in the following figure, then pull the Pushbutton Unit or the Switch Blocks. Since the lever has a hole with an inside diameter of 6.5 mm, the lever can be moved in the specified direction by inserting a screwdriver into the hole and then moving the screwdriver.

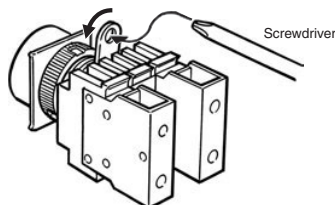

**Mounting/Replacing the Color Cap**

**Projection, Fall-guard**

- Grip and rotate the Color Cap with your fingers.

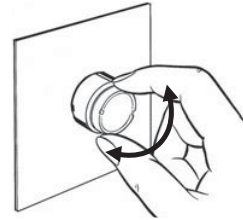

**Half-guard Indicators**

- Put the tips of the Cap Tightening Tool (A22Z-3908) into the Color Cap slot and turn the Tool.

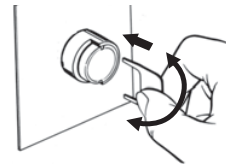

**Assembling the Cap**

**Lighted Pushbutton Switch**

- Mount the Color Cap so that the protrusions inside the cap fit into the grooves in the Pushbutton Unit.

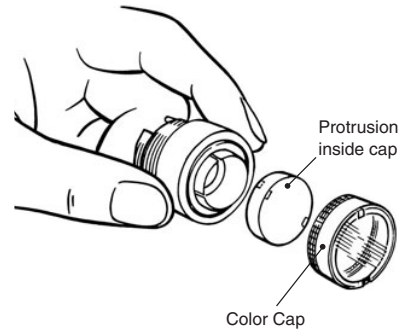

**Indicator**

- Mount the Color Cap so that the protrusions inside the Pushbutton Unit fit into the grooves in the cap.

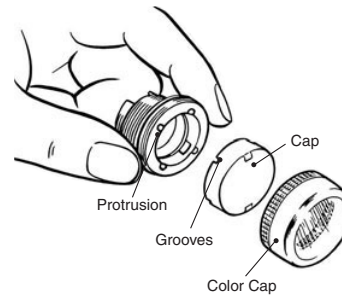

### Square Pushbutton/Indicator

• Square Pushbutton/Indicator

Insert the protruding tip of the Cap Puller (A3PJ-5080) into the Cap slot, hold the plate spring, and pull them to remove the Color Cap.

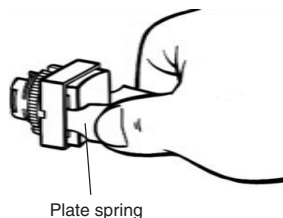
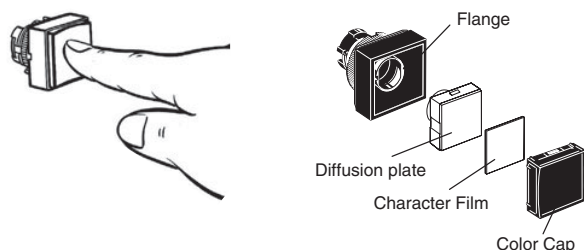

Plate spring

• Mounting the Color Cap:

Mount the Color Cap on the flange and firmly push the Color Cap. When the Color Cap is inserted, check whether it operates properly. When replacing the Lamp, remove the Color Cap and diffusion plate with fingers or Cap Puller. Attach the Character Film properly so that it fits inside the protruding part of the diffusion plate. Then, match the diffusion plate to the square flange and insert the Cap.



### Emergency Stop Switch

• Insert the protrusion of the Tightening Wrench (A22Z-3905) into the Cap slot and then turn to remove the Cap.

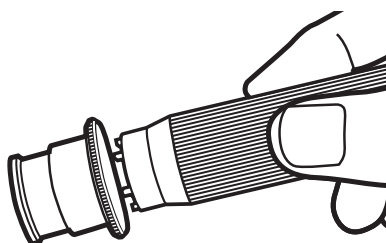

### Installing/Replacing the Lamp

#### Installing/Replacing from the Panel Surface

• Insert the Lamp Extractor (A22Z-3901) into the lamp, then rotate the Extractor while pressing it.

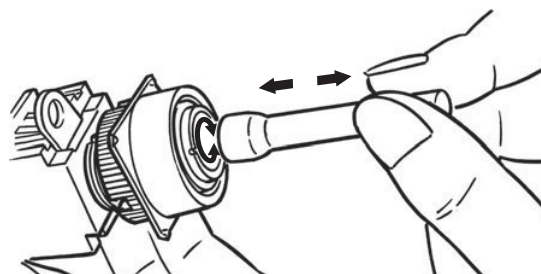

#### Installing/Replacing on the Switch

• Grip the lamp with your fingers, then rotate the lamp while pressing it against the Switch.

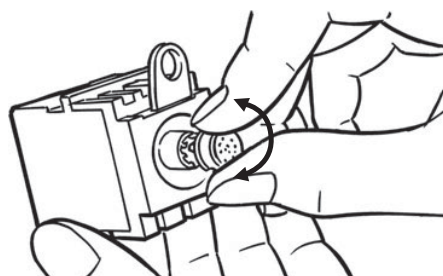

### Control Box (Enclosure)

#### Mounting the Switch

The Standard-size Legend Plate Frame can be mounted. Mount the Frame as shown in the following diagram. Mount the Switch in the same way as for an ordinary panel.

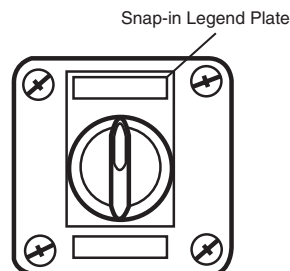

Snap-in Legend Plate

#### Creating a Cable Port Hole

Place the tip of a screwdriver on the surface where the cable port hole is to be created with the cover attached and strike the screwdriver with a hammer to punch four holes.

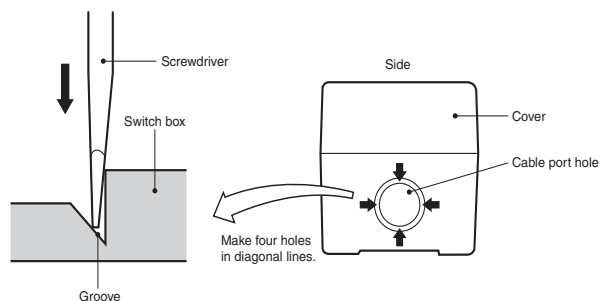

**Securing the Connector Cable**

1. Insert the connector into the cable port hole in the Box and secure with the fixing nut inside the box.
2. Open a hole in the thin rubber section of the rubber ring.
3. Pass the tightening cap through the cable, insert the cable into the connector, and tighten the hexagonal nut to secure the cable.

Cable diameter	Connector
7 to 9 dia.	A22Z-3500-1
9 to 11 dia.	A22Z-3500-2

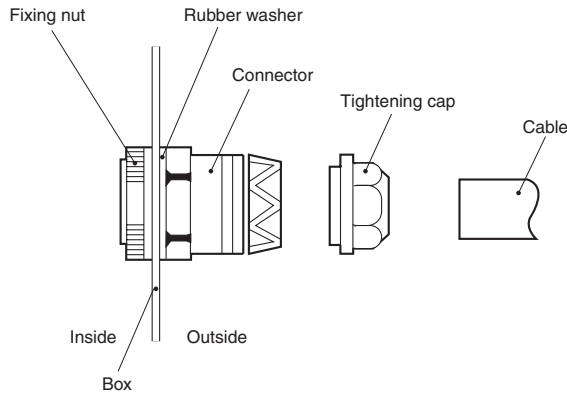

**Switch Blocks**

**Installing the Switch Blocks**

- Hook the small protrusion on the Switch Block into the groove on the Mounting Latch on the other side of the lever, then push up the Switch Block in the direction indicated by the arrow in the figure below.

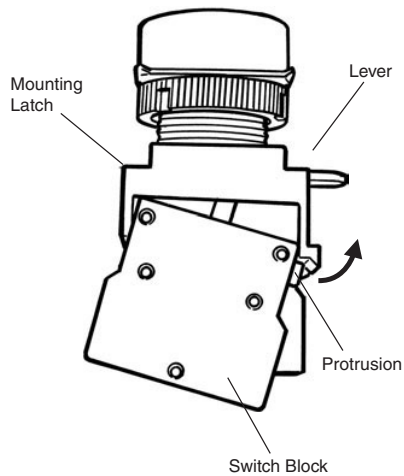

**Removing the Switch Blocks**

- Insert a screwdriver between the Mounting Latch and the Switch Block, then push down the screwdriver in the direction indicated by the arrow in the following figure.

Use either of the following screwdrivers.

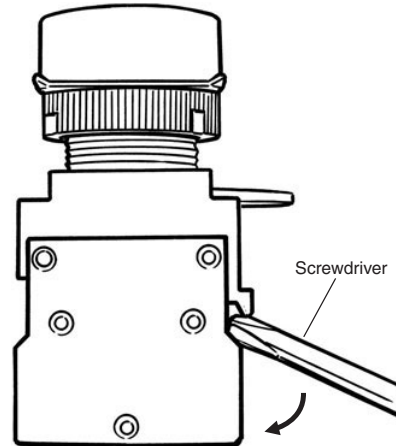
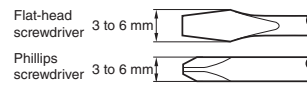

**Wiring**

**Wiring Round Crimp Terminals**

- Loosen the terminal screw from the Switch Unit until it completely comes off the groove, insert a screwdriver as shown in the following figure, then push up the washer in the direction indicated by the arrow to temporarily secure it. Now, a round crimp terminal can be connected. After inserting the terminal, tighten the screws to complete wiring.

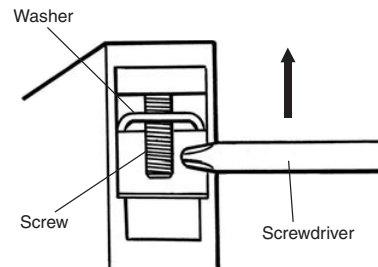

**Engraving**

- Engrave the characters on the surface on the Cap. Make sure that the characters are aligned parallel to the imaginary line connecting the two protruding portions to the left and right of the Cap.
- The characters must not be engraved deeper than 0.5 mm. Apply an alcohol-based paint coating, such as melamine, alkyd, or acrylic resin paint coating, to the engraved characters.

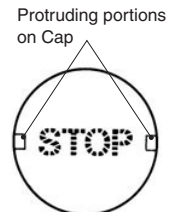

### Affixing Character Film

- Hold the Cap, remove the cardboard on the Film, and attach the Film to the Cap. Make sure that the protruding portions of the Cap engage the cutout portions of the Film and that the characters are aligned parallel to the imaginary line connecting the two protruding portions to the left and right of the Cap.

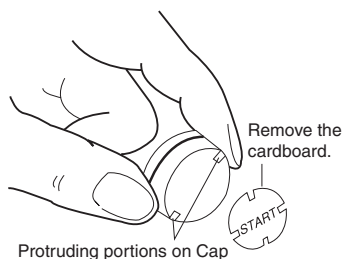

### Mounting and Dismounting Snap-in Legend

- Press and secure the Snap-in Legend Plate onto the Legend Plate Frame.
- The direction of the characters will vary with the mounting direction of the control panel if the Switch is a knob or key selector model.

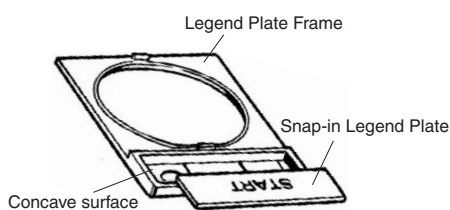

- To easily remove the Snap-in Legend Plate from the Legend Plate Frame mounted to the panel, insert a Tool with a thin tip into the space between the Snap-in Legend Plate and the Legend Plate Frame.

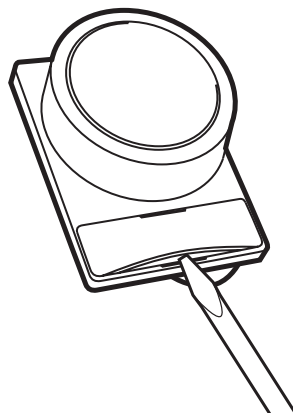

- The Snap-in Legend Plate is easily removed by pressing the Snap-in Legend Plate from the back of the Legend Plate Frame.
- The Legend Plate Frame is made of acrylic resin, which is easily damaged by shock. Be sure to handle the Legend Plate Frame with care.

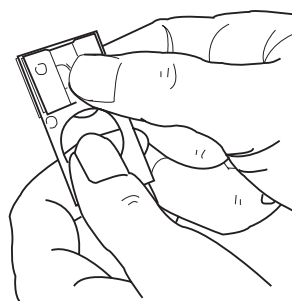

### Engraving Method

#### Material: Acrylic

- Engrave the characters directly on the matted side of the Snap-in Legend Plate.
- The characters must be engraved no deeper than 0.5 mm.
- Apply alcohol-based paint coating to the engraved characters.
- If the Snap-in Legend Plate is transparent, engrave the mirror-written characters on the back of the Snap-in Legend Plate and apply paint coating to the characters. Then apply paint coating of a different color to the remaining part of the Snap-in Legend Plate.

### Mounting Three-throw Spacer

Press and secure the two protruding portions of the Three-throw Spacer to the two indented portions of the inner side of the control panel.

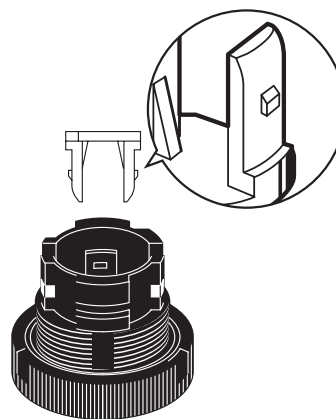

### Mounting the 30-dia. Resin Attachment

