

HRPG Series

Miniature Panel Mount Optical Encoders



Data Sheet

Description

The HRPG series is a family of miniature panel mount optical encoders, also known as Rotary Pulse Generators (RPG) and digital potentiometers. The HRPG is designed to be mounted on a front panel and used as a rotary, data-entry device. The HRPG is very flexible for numerous applications due to the many configuration options available. These options include detents or smooth, multiple terminations, versatile mounting capabilities, and different shaft configurations.

The HRPG uses optical reflective technology providing accuracy and reliability to the encoder. An LED emits a beam of light onto the specular codewheel surface. When the light strikes the surface, it projects the image of the codewheel back on the photodetector, causing the output to change. The entire detector circuit is on one IC, thus the part is less sensitive to temperature and other environmental variations.

Applications

Typical applications for the Rotary Pulse Generator include front panel instruments, audio/visual boards, and other devices requiring digital output from a turning knob.

Note: Avago Technologies encoders are not recommended for use in safety critical applications. Eg. ABS braking systems, power steering, life support systems and critical care medical equipment. Please contact sales representative if more clarification is needed.

Features

- Miniature size
- Smooth turning and detented options
- Multiple mounting bracket options
- Uses optical reflective technology
- Quadrature digital output
- Small footprint for versatile mounting
- TTL compatible

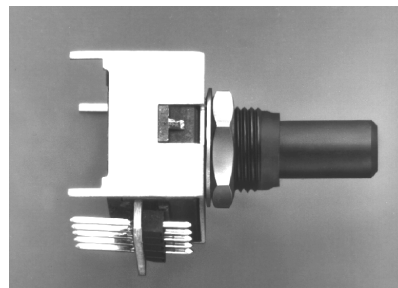
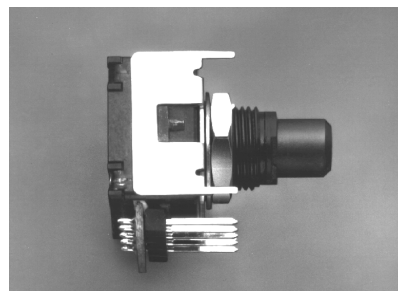

Absolute Maximum Ratings

Parameter	Symbol	Min.	Max.	Units	Notes
Storage Temperature	T_S	-40	+85	°C	
Operating Temperature	T_A	0	+70	°C	
Vibration			20	g	20 Hz to 2 kHz
Supply Voltage	V_{CC}	-0.5	7	V	
Output Voltage	V_O	-0.5	V_{CC}	V	
Output Current Per Channel	I_O	-1	5	mA	
Shaft Load – Axial			4.0	N	10 ⁶ Revolutions
Shaft Load – Radial			0.1	Nm	10 ⁶ Revolutions
Revolution Life		10 ⁶		Rev	At Maximum Loads

Recommended Operating Conditions

Parameter	Symbol	Min.	Max.	Units	Notes
Temperature	T	0	+70	°C	Noncondensing Atmosphere
Supply Voltage	V_{CC}	4.5	5.5	V	Ripple < 100 mV _{p-p}
Rotation Speed – Detented			200	RPM	
– Smooth			300	RPM	

Electrical Characteristics

Over Recommended Operating Range

Parameter	Symbol	Min.	Max.	Units	Notes
Supply Current	I_{CC}		40	mA	
High Level Output Voltage	V_{OH}	2.4		V	$I_{OH} = -40 \mu A$ Max.
Low Level Output Voltage	V_{OL}		0.4	V	$I_{OL} = 3.2$ mA

Output Waveforms

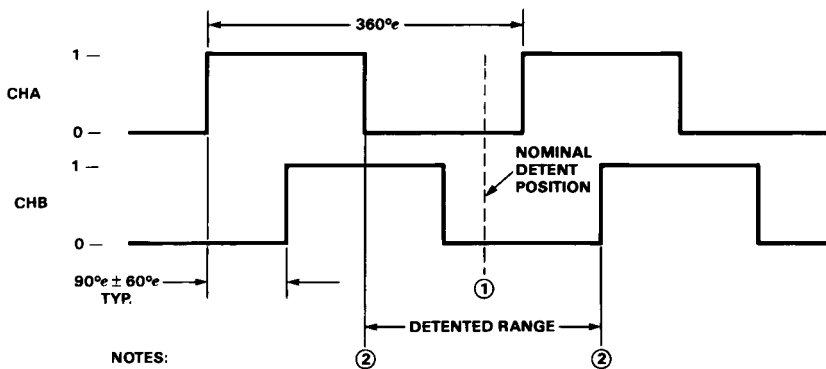

NOTES:

$$360^\circ_e = \frac{360^\circ \text{ MECH.}}{\text{CPR}}$$

CHANNEL A LEADS CHANNEL B FOR CLOCKWISE ROTATION
 CHANNEL B LEADS CHANNEL A FOR COUNTERCLOCKWISE ROTATION

- FOR HRPG-ADXX #XXX THE NOMINAL DETENT POSITION IS CENTERED AROUND LOW-LOW STATE (CHA = 0, CHB = 0).
- DETENT POSITION WILL LIE WITHIN THESE BOUNDARIES, NEVER IN HIGH-HIGH STATE (CHA = 1, CHB = 1).

Mechanical Configurations

Termination Options

Option R – Pins Rear with Bracket

HRPG-AXXX#XXR

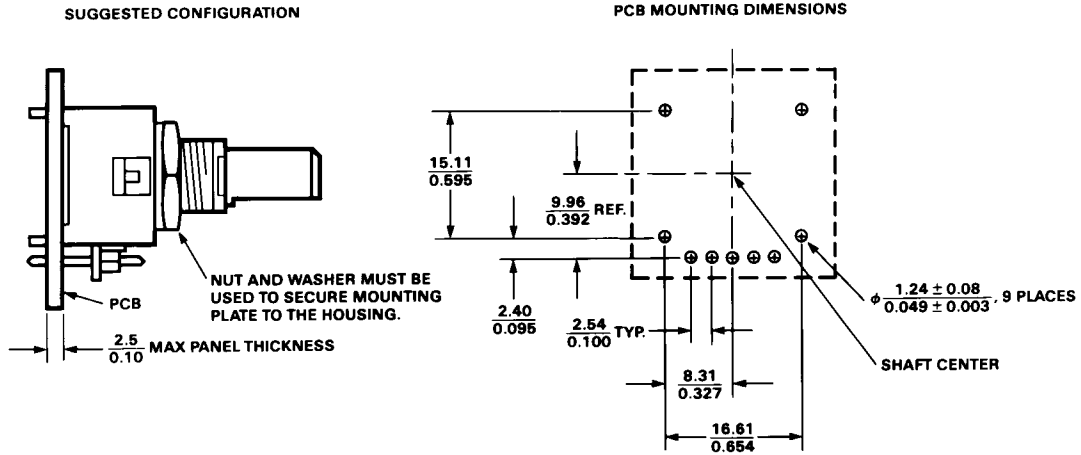

NOTES:
 DIMENSIONS ARE: $\frac{\text{mm}}{\text{INCHES}}$
 TOLERANCES ARE: $X \pm 0.25 \text{ mm}$
 $\text{XX} \pm 0.01''$
 $\text{XX} \pm 0.13 \text{ mm}$
 $\text{XXX} \pm 0.005''$

SHIELD IS FOR HOUSING ESD PATH ONLY



Option F – Pins Front with Bracket

HRPG-AXXX#XXF

SUGGESTED CONFIGURATION

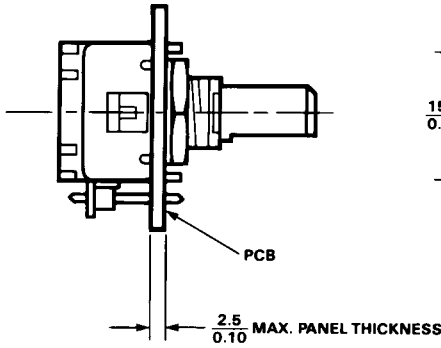

PCB MOUNTING DIMENSIONS

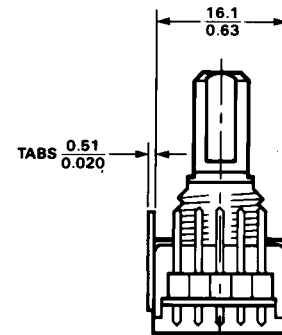
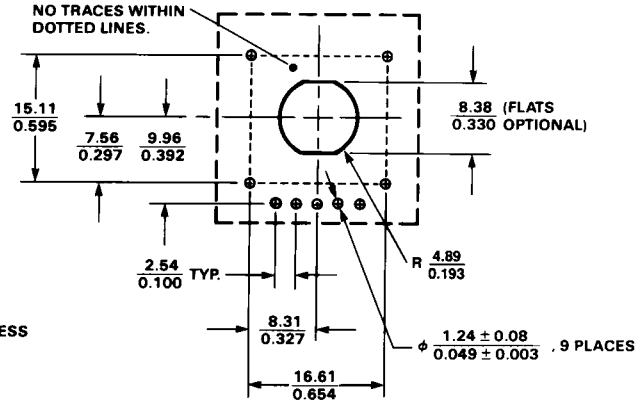

NOTES:
DIMENSIONS ARE: $\frac{\text{mm}}{\text{INCHES}}$
TOLERANCES ARE: $X \pm 0.25 \text{ mm}$
 $.XX \pm 0.01''$
 $.XX \pm 0.13 \text{ mm}$
 $.XXX \pm 0.005''$

SHIELD IS FOR HOUSING ESD PATH ONLY

1. GROUND (DOT ON BOTTOM)
2. CHANNEL B
3. V_{CC} (+5 VOLTS)
4. CHANNEL A
5. SHIELD (HOUSING GROUND)

Option C – Cable Connector with Strain Relief

HRPG-AXXX#XXC







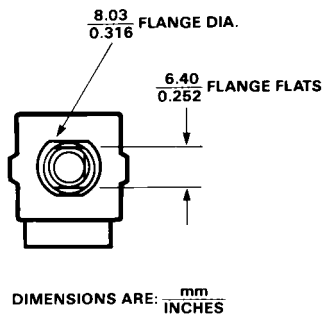
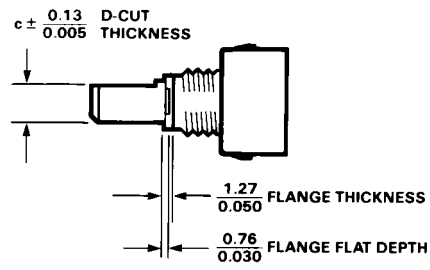

Shaft Configurations

Shaft Dimensions (D-cut shown also)

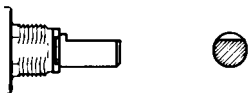

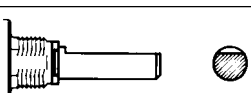
Shaft Options Available

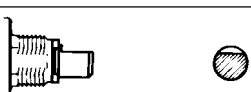
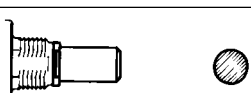
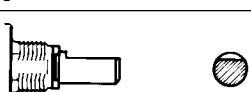
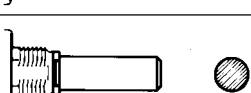
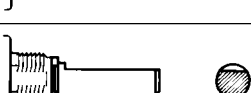
Option #	Shaft Length (l)	Shaft Diameter (d)	D-Cut Thickness (c)	D-Cut Length (b)	Sketch (not to scale)
11	0.30"	0.251"	-	-	
13	0.30"	0.250"	0.225"	0.230"	
14	0.50"	0.251"	-	-	
16	0.50"	0.250"	0.225"	0.400"	
17	0.80"	0.251"	-	-	
19	0.80"	0.250"	0.225"	0.700"	
51	7.6 mm	6.02 mm	-	-	
53	7.6 mm	6.00 mm	5.33 mm	5.84 mm	
54	12.7 mm	6.02 mm	-	-	
56	12.7 mm	6.00 mm	5.33 mm	10.16 mm	
57	20.32 mm	6.02 mm	-	-	
59	20.32 mm	6.00 mm	5.33 mm	17.78 mm	

Typical Interface

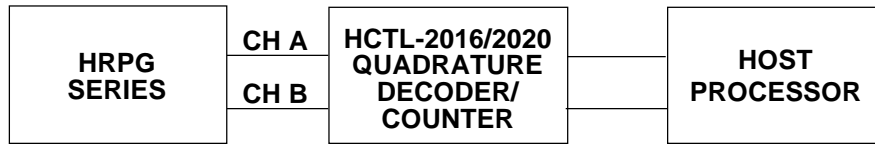

Ordering Information

HRPG - A #

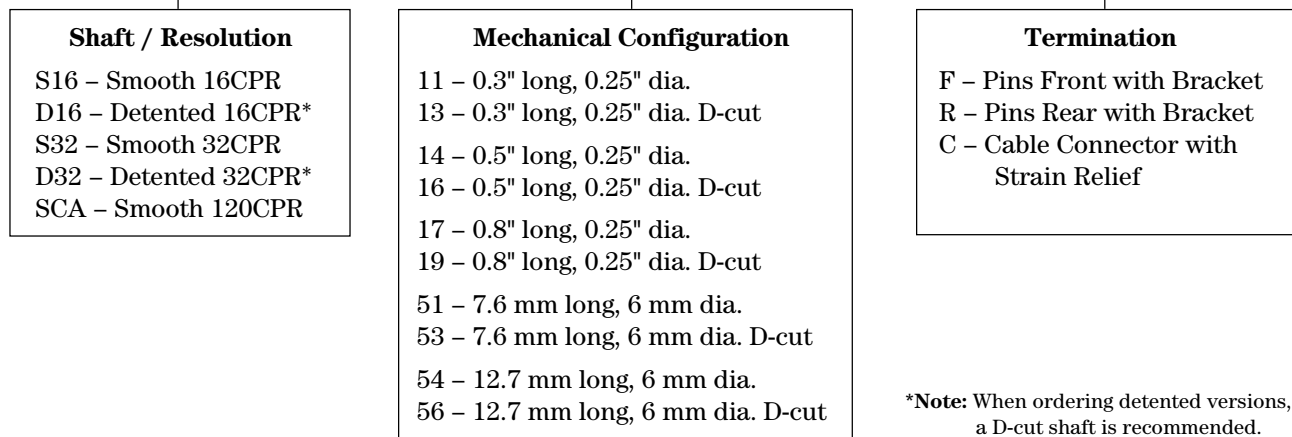

HRPG Series		11	13	14	16	17	19	51	53	54	56	57	59
AD16	F				*					*	*		*
	R				*			*		*			
	C				*						*		
	L												
AD32	F		*	*	*		*	*	*			*	*
	R	*	*	*	*		*		*	*	*		*
	C	*	*	*	*	*		*	*	*	*		*
	L												
AS16	F					*				*			
	R	*							*				
	C			*				*					
	L												
AS32	F	*	*								*		
	R		*	*					*				
	C			*									*
	L												
ASCA	F	*		*	*	*	*		*	*	*	*	*
	R	*	*	*	*	*	*		*	*	*		
	C	*	*	*	*	*	*		*	*	*		*
	L												

For product information and a complete list of distributors, please go to our website: www.avagotech.com

Avago, Avago Technologies, and the A logo are trademarks of Avago Technologies, Pte. in the United States and other countries.
Data subject to change. Copyright © 2006 Avago Technologies Pte. All rights reserved. Obsoletes 5988-3995EN
5988-5851EN April 11, 2006

