



K90DWN2-V1-F

Product

Standard LCD Module
800 x RGB x 480 Dots
9 inch 16.7M colors TFT display
Wide temperature
With white LED backlight
With resistive touch screen



CONTENTS

	<u>Page No.</u>
1. DOCUMENT REVISION HISTORY	3
2. GENERAL DESCRIPTION	4
3. MECHANICAL SPECIFICATIONS	5-6
4. INTERFACE SIGNALS	7
5. ABSOLUTE MAXIMUM RATINGS	8
6. ELECTRICAL SPECIFICATIONS	8
7. OPTICAL CHARACTERISTICS	9
8. TIMING CHARACTERISTICS	10
9. RELIABILITY TEST ITEM	12
10. SUGGESTIONS FOR USING LCD MODULES	13
12. PACKING(REFERENCE ONLY)	14



1. Document revision history :

DOCUMENT REVISION	DATE	DESCRIPTION	PREPARED BY	APPROVED BY
01	2010.09.29	First Release.	MF Zou	
02	2010.12.30	Correct typing error.	MF Zou	



2. General Description

NO.	Item	Unit	Specification	Remark
1	Screen Size	inch	9(Diagonal)	
2	Display Resolution	Dot	800RGB(W)x480(H)	
3	Overall Dimension	mm	211.1(W)x126.5(H)x8.8 (D)	Note 1
4	Active Area	mm	198.0(W)x111.7(H)	
5	Pixel Pitch	mm	0.2327(W)x0.2327(H)	
6	Color Configuration	-	Tri-Gate	
7	Color Depth	-	16.7M Color	Note 2
8	NTSC Ratio	%	50	
9	Display Mode	-	Normally White	
10	Panel Surface Treatment	-	Anti-Glare, 3H	
11	Weight	g	TBD	
12	Panel Power Consumption	mW	TBD	
13	Backlight Power Consumption	W	2.2(typ.)	
14	Viewing Direction		6 o'clock(Gray inversion)	

Note 1: Not include controller board and FPC.

Note 2: Full color display depends on 24-bit data signal.



3. Mechanical Specifications

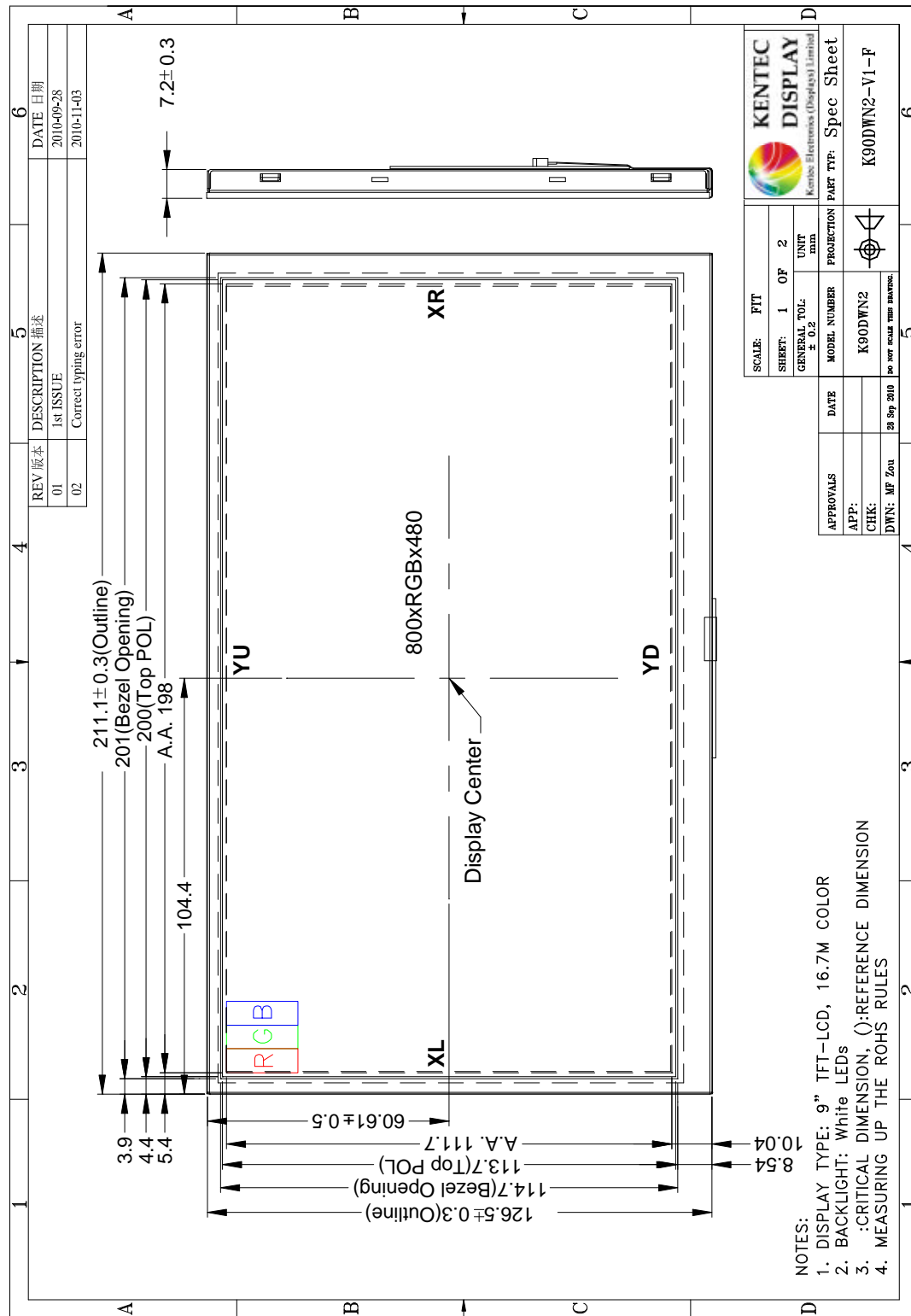
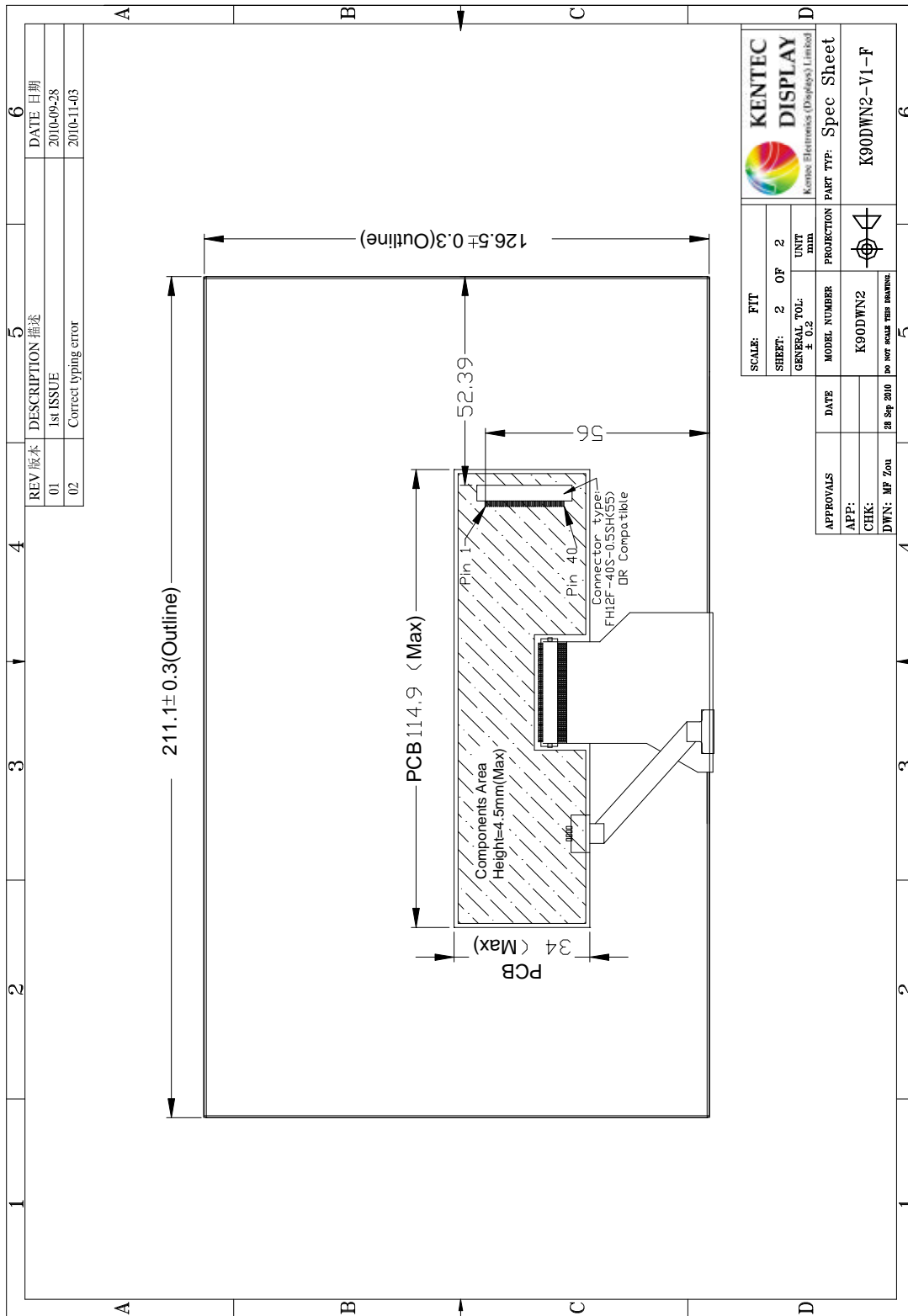

Figure 1-1: Outline Drawing 1

NOTES:

1. DISPLAY TYPE: 9" TFT-LCD, 16.7M COLOR
2. BACKLIGHT: White LEDs
3. :CRITICAL DIMENSION, ():REFERENCE DIMENSION
4. MEASURING UP THE ROHS RULES



SCALE: FIT		KENTEC DISPLAY	
SHEET: 2	OF 2	Kentec Electronics (Displays) Limited	
GENERAL TOL: ± 0.2		UNIT: mm	PROJECTION: 1st Angle
APPROVALS:	DATE:	MODEL NUMBER: K90DWN2	PART TYP: Spec Sheet
APP:		CHK:	K90DWN2-V1-F
DWN: MF Zou	28 Sep 2010	DO NOT SCALE THIS DRAWING.	

Figure 1-2: Outline Drawing 2



4. Interface signals

Table 2: Pin assignment

Pin No.	Symbol	Description
1	GND	Ground for digital circuit
2	VDD	Power supply for digital circuit (VDD = 3.3V).
3	AVDD	Power supply for analog circuit (AVDD = 5V).
4	RESET	External reset, active low.
5	CS	Chip select, active low.
6	RS	Command/data select.
7	WR	Write control.
8	RD	Read control.
9-24	[DB0-DB15]	16bit data bus
25	NC	NO CONNECT
26	GND	Ground for digital circuit
27-29	NC	NO CONNECT
30	GND	Ground for digital circuit
31-32	AGND	Ground for analog circuit
33-34	AVDD	Power supply for analog circuit (AVDD = 5V).
35,36	NC	NO CONNECT
37	YU	Touch panel terminal
38	XL	
39	YD	
40	XR	



5. Absolute Maximum Ratings

5.1 Electrical Maximum Ratings – for IC Only

Table 3: Electrical Maximum Ratings – for IC

Parameter	Symbol	Min.	Max.	Unit	Note
Supply voltage	VCC	-0.3	5.0	V	1
LED forward current	If	--	30	mA	
LED reverse	Vr	--	5.0	V	

Note:

- 1.VCC, GND must be maintained.
- 2.The modules may be destroyed if they are used beyond the absolute maximum ratings.

5.2 Environmental Condition

Table 4

Item	Operating temperature (Topr)		Storage temperature (Tstg) (Note 1)		Remark
	Min.	Max.	Min.	Max.	
Ambient temperature	-20°C	+70°C	-30°C	+80°C	Dry
Humidity (Note 1)	80% max. RH for Ta ≤ 40°C < 50% RH for 40°C < Ta ≤ Maximum operating temperature				No condensation

Note 1: Product cannot sustain at extreme storage conditions for long time.

6. Electrical Specifications

Typical Electrical Characteristics

At Ta = 25 °C, VCC=IOVCC= 3.3V, GND=0V.

Table 5

Parameter	Symbol	Conditions	Min.	Typ.	Max.	Unit
Supply voltage (logic)	VDD-GND		3	3.3	3.6	V
Supply voltage (analog)	AVDD-GND		4.8	5.0	5.2	V
Input signal voltage	VIH		0.8VDD	-	VDD	V
	VIL		0	-	0.2VDD	V
Supply current (Logic & LCD)	IDD	VDD=3.3V	-	15	19	mA
Supply current (Analog & LED)	IA	AVDD=5.0V	-	T.B.D.	T.B.D.	V



7. Optical Characteristics

Table 6: Optical specifications

Items	Symbol	Condition	Specifications			Unit	Note
			Min.	Typ.	Max.		
Luminance	L _w		200	250	-	cd/m ²	
Contrast Ratio	CR		400	500	-	-	
Response Time	T _R +T _F		-	25	50	ms	
Chromaticity	White	X _w	(0.26)	(0.31)	(0.36)	-	
		Y _w	(0.28)	(0.33)	(0.38)	-	
Viewing angle	Hor.	φ1 + φ2	Center CR=10	120	140	-	deg.
	Ver.	θ1 + θ2		100	120	-	

Note 1: Definition of Contrast Ratio (CR):

The contrast ratio can be calculated by the following expression.

$$\text{Contrast Ratio (CR)} = L_{63} / L_0$$

L₆₃: Luminance of gray level 63

L₀: Luminance of gray level 0

$$\text{CR} = \text{CR} (10)$$

CR (X) is corresponding to the Contrast Ratio of the point X at Figure in Note 5.

Note 2: Definition of Response Time (TR, TF):

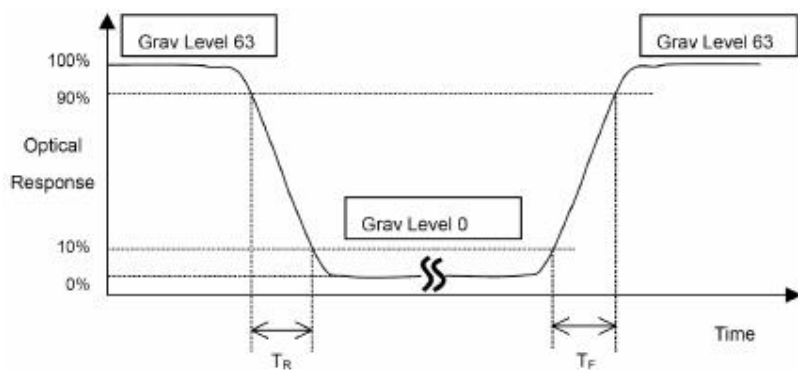

Figure 3

Note 3: Viewing Angle

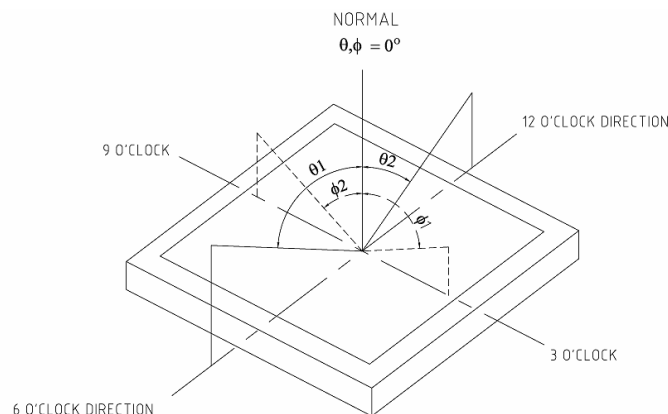

Figure 4



The above “Viewing Angle” is the measuring position with Largest Contrast Ratio; not for good image quality. View Direction for good image quality is 6 O’clock. Module maker can increase the “Viewing Angle” by applying Wide View Film.

Note 4: Measurement Set-Up:

The LCD module should be stabilized at a given temperature for 20 minutes to avoid abrupt temperature change during measuring. In order to stabilize the luminance, the measurement should be executed after lighting Backlight for 20 minutes in a windless room.

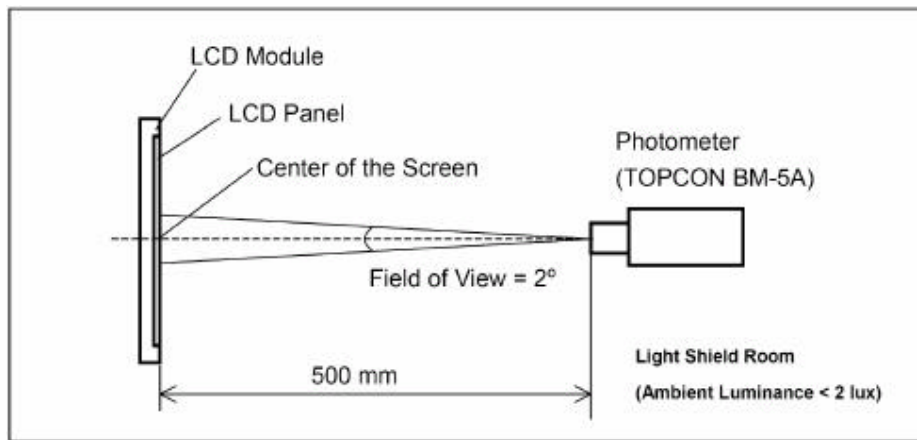
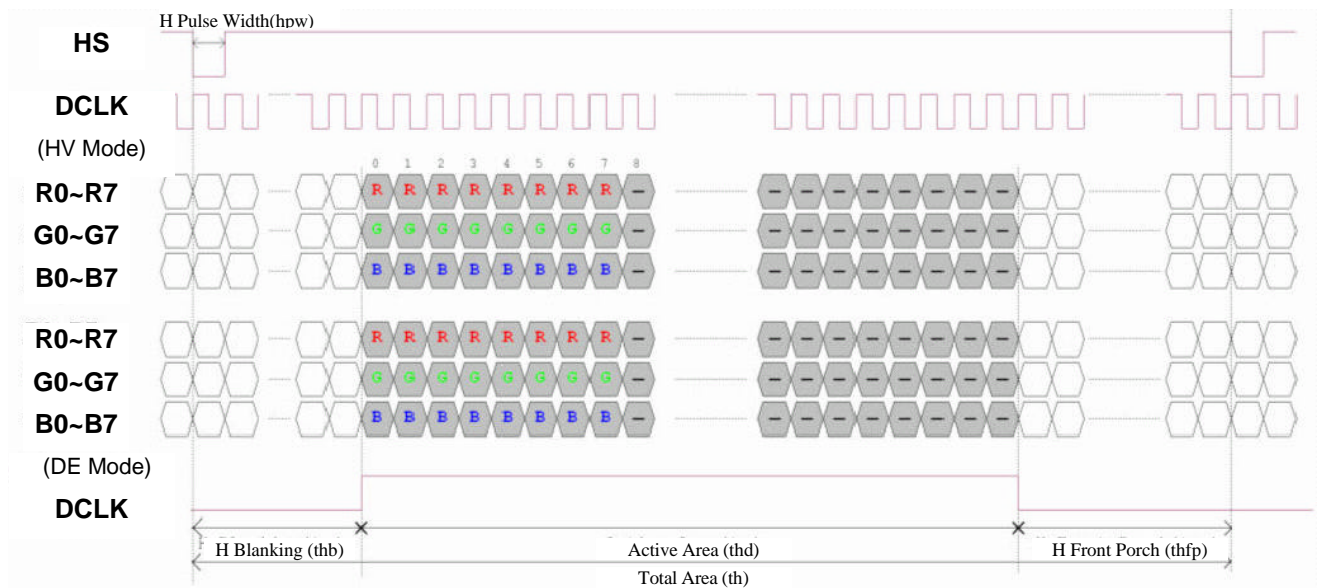

Figure 5

8. AC Characteristics and Signal timing

8.1 Please refer SSD1963 datasheet.

8.2 LCD data input format.





8.2 Horizontal input timing.

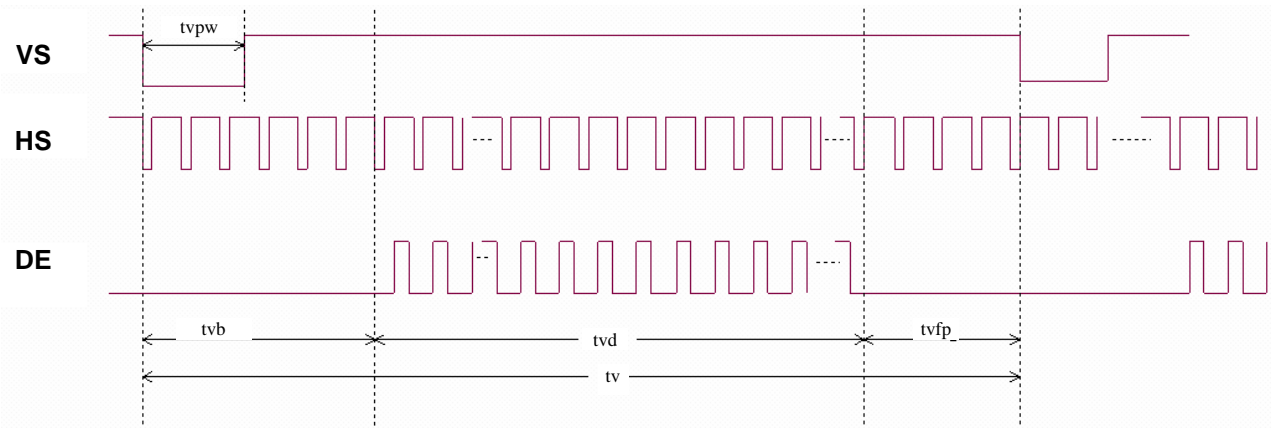

8.3 Timing

Item	Symbol	Values			Unit	Remark
		Min.	Typ.	Max.		
Horizontal Display Area	thd	-	800	-	DCLK	
DCLK Frequency	fclk	26.4	33.3	46.8	MHz	
One Horizontal Line	th	862	1056	1200	DCLK	
HS Pulse Width	thpw	1	-	40	DCLK	
HS Blanking	thb	46	46	46	DCLK	
HS Front Porch	thfp	16	21	354	DCLK	
Vertical Display Area	tvd	-	480	-	TH	
VS Period Time	tv	510	525	650	TH	
VS Pulse Width	tvpw	1	-	20	TH	
VS Blanking	tvb	23	23	23	TH	
VS Front Porch	tvfp	7	22	147	TH	



9. Reliability Test Item

	Test Item	Test Condition	Remark
1	High temperature storage	70 ; 240H	
2	Low temperature storage	-20 ; 240H	
3	High temperature High humidity	50 , 80%RH; 240H	Operation
4	High temperature operation	60 ; 240H	
5	Low temperature operation	-10 ; 240H	
6	Temperature Shock	-20 ? 60 ; 100cycle, 1Hrs/cycle	Non-operation
7	Electrostatic Discharge	Contact ±4kV, Class B Air ±8kV, Class B	
8	Image sticking	25 , 4H	
9	Vibration	Frequency range : 10~55Hz Stoke : 1.5mm Sweep : 10~55~10Hz 2 Hours for each direction of X,Y,Z (total 6 Hours)	Non-operation JIS C7021, A-10 Conduction A : 15 minutes
10	Mechanical shock	100G, 6ms, ±X, ±Y, ±Z, 3 times for each direction	Non-operation JIS C7021, A-10 Conduction C
11	Vibration (with carton)	Random vibration : 0.015G ² /Hz from 2~200Hz -6dB/Octave from 200~500Hz	ICE 68-34
12	Drop (with carton)	Height : 60cm 1 corner, 3 edges, 6 surfaces	
13	Pressure	5 kg, 5 sec	



10. Suggestions for using LCD modules

10.1 Handling of LCM

1. The LCD screen is made of glass. Don't give excessive external shock, or drop from a high place.
2. If the LCD screen is damaged and the liquid crystal leaks out, do not lick and swallow. When the liquid is attach to your hand, skin, cloth etc, wash it off by using soap and water thoroughly and immediately.
3. Don't apply excessive force on the surface of the LCM.
4. If the surface is contaminated ,clean it with soft cloth. If the LCM is severely contaminated , use Isopropyl alcohol/Ethyl alcohol to clean. Other solvents may damage the polarizer . The following solvents is especially prohibited: water , ketone Aromatic solvents etc.
5. Exercise care to minimize corrosion of the electrode. Corrosion of the electrodes is accelerated by water droplets, moisture condensation or a current flow in a high-humidity environment.
6. Install the LCD Module by using the mounting holes. When mounting the LCD module make sure it is free of twisting, warping and distortion. In particular, do not forcibly pull or bend the I/O cable or the backlight cable.
7. Don't disassemble the LCM.
8. To prevent destruction of the elements by static electricity, be careful to maintain an optimum work environment.
 - Be sure to ground the body when handling the LCD modules.
 - Tools required for assembling, such as soldering irons, must be properly grounded.
 - To reduce the amount of static electricity generated, do not conduct assembling and other work under dry conditions.
 - The LCD module is coated with a film to protect the display surface. Exercise care when peeling off this protective film since static electricity may be generated.
9. Do not alter, modify or change the the shape of the tab on the metal frame.
10. Do not make extra holes on the printed circuit board, modify its shape or change the positions of components to be attached.



11. Do not damage or modify the pattern writing on the printed circuit board.
12. Absolutely do not modify the zebra rubber strip (conductive rubber) or heat seal connector
13. Except for soldering the interface, do not make any alterations or modifications with a soldering iron.
14. Do not drop, bend or twist LCM.

10.2 Storage

1. Store in an ambient temperature of 5 to 45 °C, and in a relative humidity of 40% to 60%. Don't expose to sunlight or fluorescent light.
2. Storage in a clean environment, free from dust, active gas, and solvent.
3. Store in antistatic container.

11. Packing Method

TBD

- END -