

# HRPG Series

## Miniature Panel Mount Optical Encoders



### Data Sheet

#### Description

The HRPG series is a family of miniature panel mount optical encoders, also known as Rotary Pulse Generators (RPG) and digital potentiometers. The HRPG is designed to be mounted on a front panel and used as a rotary, data-entry device. The HRPG is very flexible for numerous applications due to the many configuration options available. These options include detents or smooth, multiple terminations, versatile mounting capabilities, and different shaft configurations.

The HRPG uses optical reflective technology providing accuracy and reliability to the encoder. An LED emits a beam of light onto the specular codewheel surface. When the light strikes the surface, it projects the image of the codewheel back on the photodetector, causing the output to change. The entire detector circuit is on one IC, thus the part is less sensitive to temperature and other environmental variations.

#### Applications

Typical applications for the Rotary Pulse Generator include front panel instruments, audio/visual boards, and other devices requiring digital output from a turning knob.

Note: Avago Technologies encoders are not recommended for use in safety critical applications. Eg. ABS braking systems, power steering, life support systems and critical care medical equipment. Please contact sales representative if more clarification is needed.

#### Features

- Miniature size
- Smooth turning and detented options
- Multiple mounting bracket options
- Uses optical reflective technology
- Quadrature digital output
- Small footprint for versatile mounting
- TTL compatible

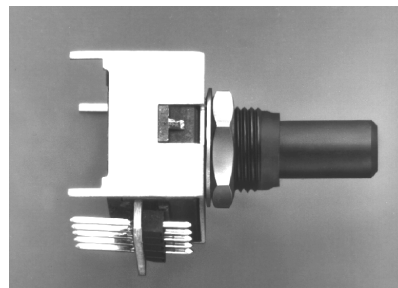
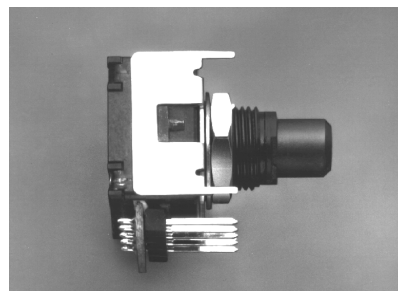

## Absolute Maximum Ratings

Parameter	Symbol	Min.	Max.	Units	Notes
Storage Temperature	$T_S$	-40	+85	°C	
Operating Temperature	$T_A$	0	+70	°C	
Vibration			20	g	20 Hz to 2 kHz
Supply Voltage	$V_{CC}$	-0.5	7	V	
Output Voltage	$V_O$	-0.5	$V_{CC}$	V	
Output Current Per Channel	$I_O$	-1	5	mA	
Shaft Load – Axial			4.0	N	10 <sup>6</sup> Revolutions
Shaft Load – Radial			0.1	Nm	10 <sup>6</sup> Revolutions
Revolution Life		10 <sup>6</sup>		Rev	At Maximum Loads

## Recommended Operating Conditions

Parameter	Symbol	Min.	Max.	Units	Notes
Temperature	T	0	+70	°C	Noncondensing Atmosphere
Supply Voltage	$V_{CC}$	4.5	5.5	V	Ripple < 100 mV <sub>p-p</sub>
Rotation Speed – Detented			200	RPM	
– Smooth			300	RPM	

## Electrical Characteristics

Over Recommended Operating Range

Parameter	Symbol	Min.	Max.	Units	Notes
Supply Current	$I_{CC}$		40	mA	
High Level Output Voltage	$V_{OH}$	2.4		V	$I_{OH} = -40 \mu A$ Max.
Low Level Output Voltage	$V_{OL}$		0.4	V	$I_{OL} = 3.2$ mA

## Output Waveforms

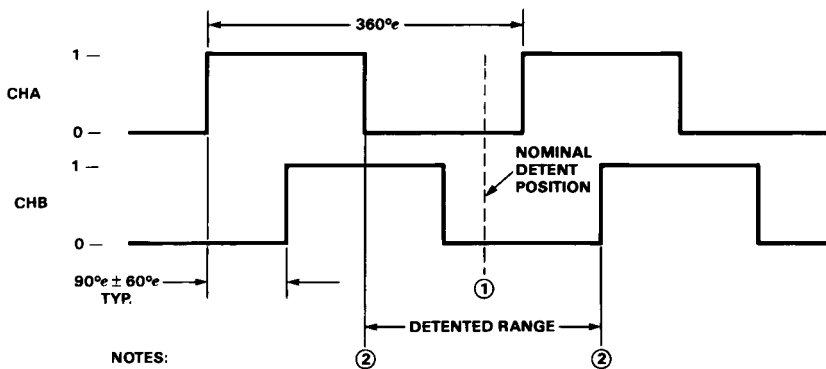

### NOTES:

$$360^\circ_e = \frac{360^\circ \text{ MECH.}}{\text{CPR}}$$

CHANNEL A LEADS CHANNEL B FOR CLOCKWISE ROTATION  
CHANNEL B LEADS CHANNEL A FOR COUNTERCLOCKWISE ROTATION

- FOR HRPG-ADXX #XXX THE NOMINAL DETENT POSITION IS CENTERED AROUND LOW-LOW STATE (CHA = 0, CHB = 0).
- DETTENT POSITION WILL LIE WITHIN THESE BOUNDARIES, NEVER IN HIGH-HIGH STATE (CHA = 1, CHB = 1).

# Mechanical Configurations

## Termination Options

### Option R – Pins Rear with Bracket

HRPG-AXXX#XXR

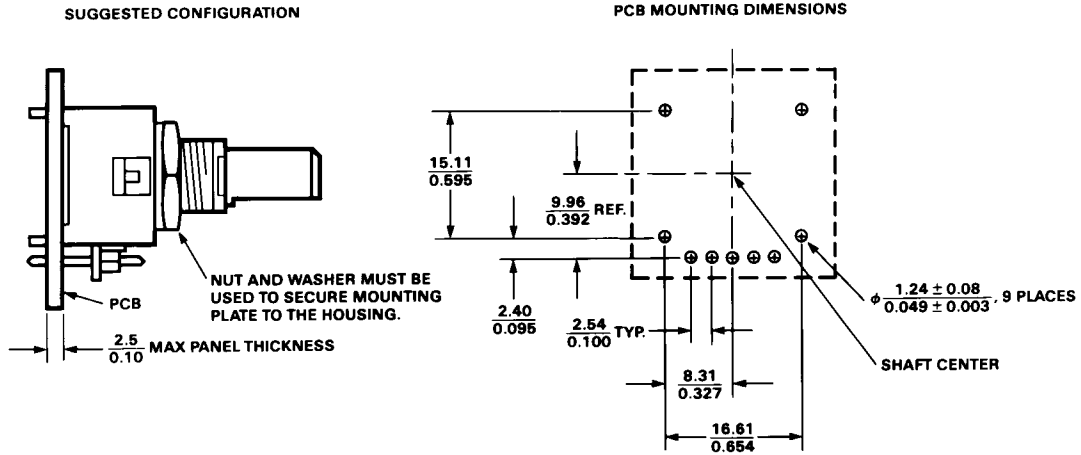

NOTES:  
 DIMENSIONS ARE:  $\frac{\text{mm}}{\text{INCHES}}$   
 TOLERANCES ARE:  $X \pm 0.25 \text{ mm}$   
 $\text{XX} \pm 0.01''$   
 $\text{.XX} \pm 0.13 \text{ mm}$   
 $\text{.XXX} \pm 0.005''$

SHIELD IS FOR HOUSING ESD PATH ONLY



Option F – Pins Front with Bracket

HRPG-AXXX#XXF

SUGGESTED CONFIGURATION

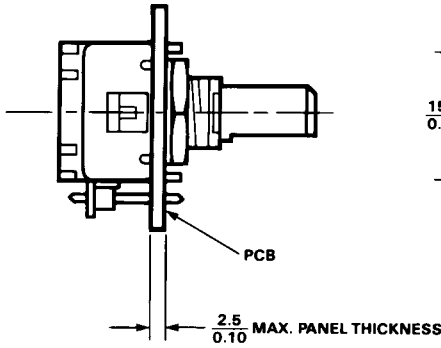

PCB MOUNTING DIMENSIONS

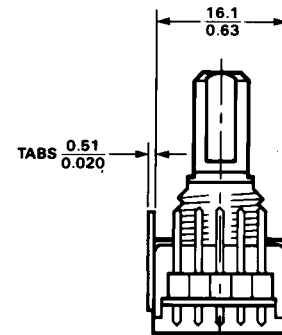
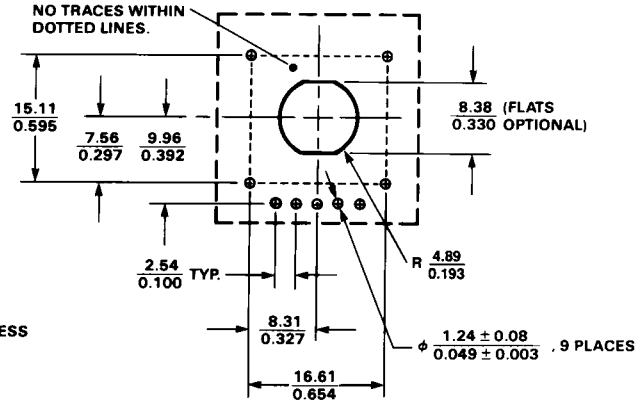

1. GROUND (DOT ON BOTTOM)
2. CHANNEL B
3. V<sub>CC</sub> (+5 VOLTS)
4. CHANNEL A
5. SHIELD (HOUSING GROUND)

NOTES:  
 DIMENSIONS ARE:  $\frac{\text{mm}}{\text{INCHES}}$   
 TOLERANCES ARE:  $X \pm 0.25 \text{ mm}$   
 $\text{.XX} \pm 0.01 \text{''}$   
 $\text{.XX} \pm 0.13 \text{ mm}$   
 $\text{.XXX} \pm 0.005 \text{''}$

SHIELD IS FOR HOUSING ESD PATH ONLY

Option C – Cable Connector with Strain Relief

HRPG-AXXX#XXC







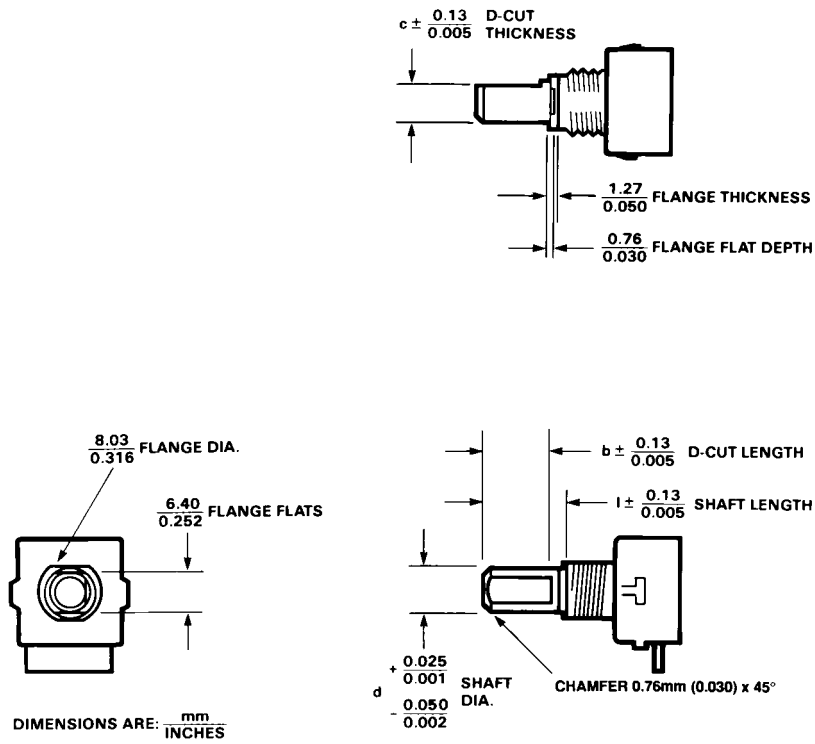

## Shaft Configurations

### Shaft Dimensions (D-cut shown also)

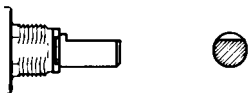

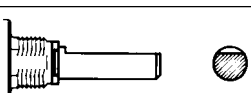
### Shaft Options Available

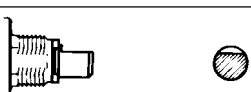
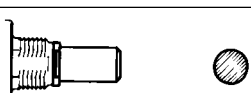
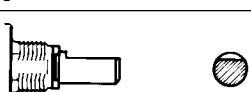
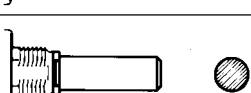
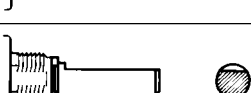
Option #	Shaft Length (l)	Shaft Diameter (d)	D-Cut Thickness (c)	D-Cut Length (b)	Sketch (not to scale)
11	0.30"	0.251"	-	-	
13	0.30"	0.250"	0.225"	0.230"	
14	0.50"	0.251"	-	-	
16	0.50"	0.250"	0.225"	0.400"	
17	0.80"	0.251"	-	-	
19	0.80"	0.250"	0.225"	0.700"	
51	7.6 mm	6.02 mm	-	-	
53	7.6 mm	6.00 mm	5.33 mm	5.84 mm	
54	12.7 mm	6.02 mm	-	-	
56	12.7 mm	6.00 mm	5.33 mm	10.16 mm	
57	20.32 mm	6.02 mm	-	-	
59	20.32 mm	6.00 mm	5.33 mm	17.78 mm	

## Typical Interface

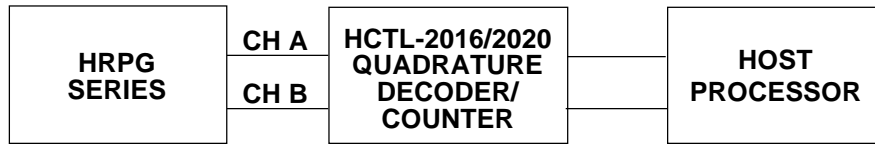

## Ordering Information

HRPG - A    #

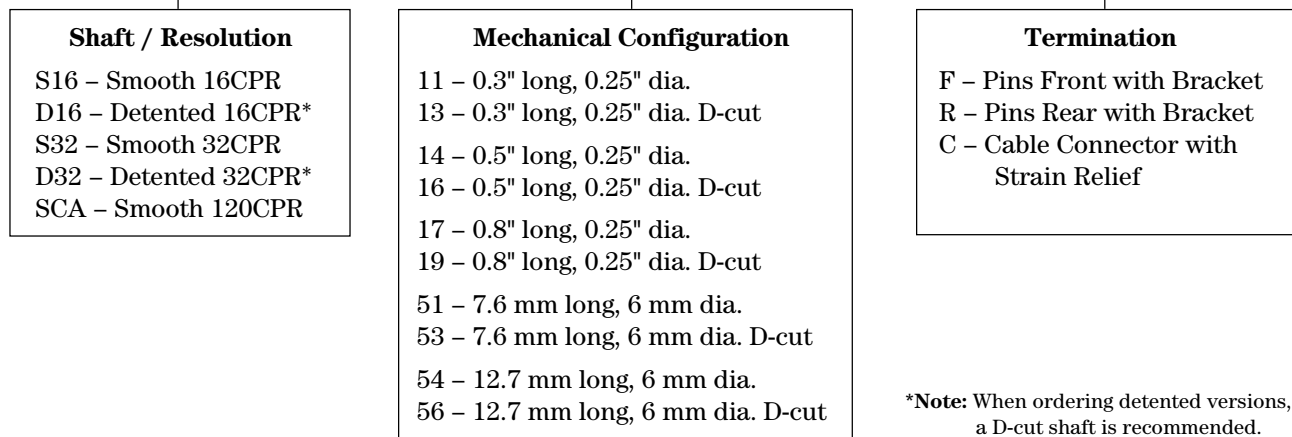

HRPG Series		11	13	14	16	17	19	51	53	54	56	57	59
AD16	F				*					*	*		*
	R				*			*		*			
	C				*						*		
	L												
AD32	F		*	*	*		*	*	*			*	*
	R	*	*	*	*		*		*	*	*		*
	C	*	*	*	*	*		*	*	*	*		*
	L												
AS16	F					*				*			
	R	*							*				
	C			*				*					
	L												
AS32	F	*	*								*		
	R		*	*					*				
	C			*									*
	L												
ASCA	F	*		*	*	*	*		*	*	*	*	*
	R	*	*	*	*	*	*		*	*	*		
	C	*	*	*	*	*	*		*	*	*		*
	L												



For product information and a complete list of distributors, please go to our website: [www.avagotech.com](http://www.avagotech.com)

Avago, Avago Technologies, and the A logo are trademarks of Avago Technologies, Pte. in the United States and other countries.  
Data subject to change. Copyright © 2006 Avago Technologies Pte. All rights reserved. Obsoletes 5988-3995EN  
5988-5851EN April 11, 2006

