

**Data Sheet**

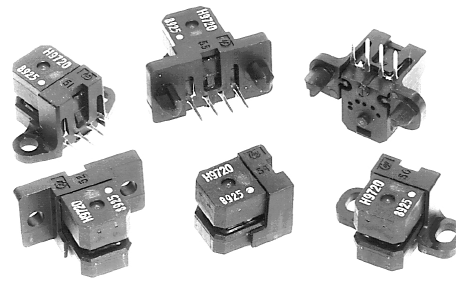

**Description**

The HEDS-973x series is a high performance, low cost, optical incremental encoder module. When operated in conjunction with either a codewheel or codestrip, this module detects rotary or linear position. The module consists of a lensed LED source and a detector IC enclosed in a small C-shaped plastic package. Due to a highly collimated light source and a unique photodetector array, the module is extremely tolerant to mounting misalignment.

**Features**

- Small size
- Low cost
- Multiple mounting options
- Wide resolution range
- Linear and rotary options available
- No signal adjustment required
- Insensitive to radial and axial play
- -40°C to +85°C operating temperature
- High resolution version of the HEDS-970x
- Two channel quadrature output
- TTL compatible
- Single 5 V supply
- Wave solderable

**Package Dimensions**

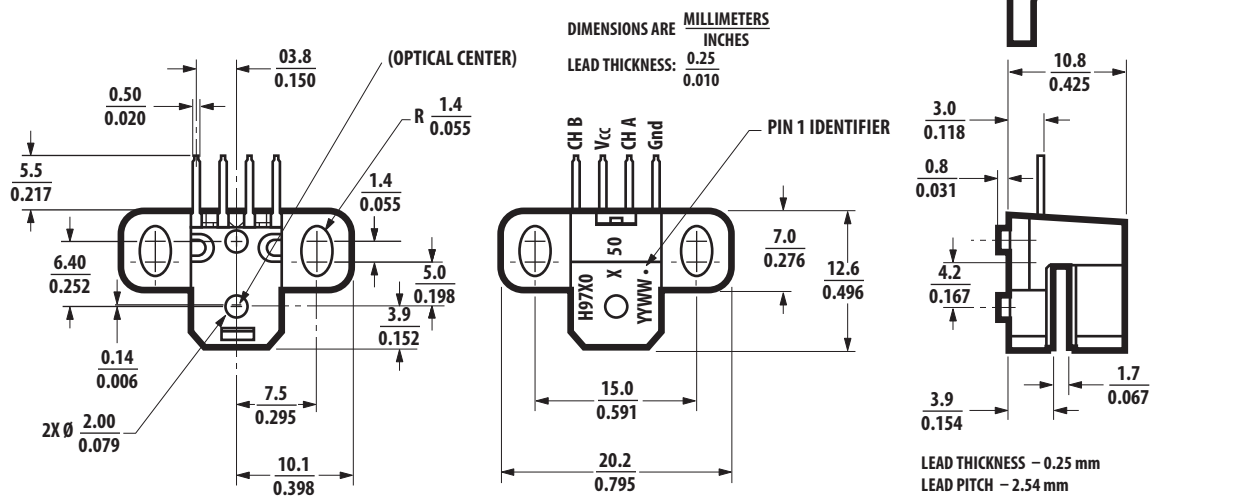

Mounting Option #50 - Standard (Baseplane Mounting)

Contact Factory for Detailed Package Dimensions

**ESD WARNING:** Normal handling precautions should be taken to avoid static discharge.

The two channel digital outputs and 5 V supply input are accessed through four solder-plated leads located on 2.54 mm (0.1 inch) centers.

The standard HEDS-973x is designed for use with an 11 mm optical radius codewheel, or linear codestrip. Other options are available. Please contact factory for more information.

## Applications

The HEDS-973x provides sophisticated motion detection at a low cost, making closed-loop control very cost-competitive! Typical applications include printers, plotters, copiers, and office automation equipment.

Note: Avago Technologies encoders are not recommended for use in safety critical applications. Eg. ABS braking systems, power steering, life support systems and critical care medical equipment. Please contact sales representative if more clarification is needed.

## Theory of Operation

The HEDS-973X is a C-shaped emitter/detector module. Coupled with a codewheel, it translates rotary motion into a two-channel digital output. Coupled with a codestrip, it translates linear motion into a digital output.

As seen in the block diagram, the module contains a single Light Emitting Diode (LED) as its light source. The light is collimated into a parallel beam by means of a single lens located directly over the LED. Opposite the emitter is the integrated detector circuit. This IC consists of multiple sets of photodiodes and the signal processing circuitry necessary to produce the digital waveforms.

The codewheel/codestrip moves between the emitter and detector, causing the light beam to be interrupted by the pattern of spaces and bars on the codewheel/codestrip. The photodiodes which detect these interruptions are arranged in a pattern that corresponds to the radius and count density of the codewheel/codestrip. These detectors are also spaced such that a light period on one pair of detectors corresponds to a dark period on the adjacent pair of detectors. The photodiode outputs are fed through the signal processing circuitry. Two comparators receive these signals and produce the final outputs for channels A and B. Due to this integrated phasing technique, the digital output of channel A is in quadrature with channel B (90 degrees out of phase).

## Block Diagram

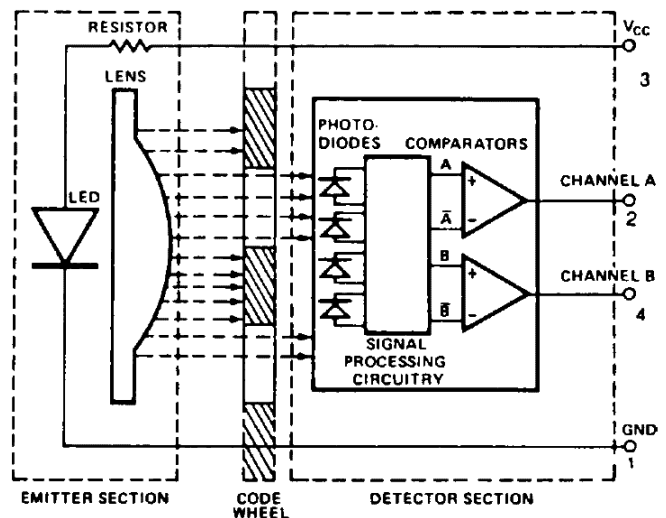

## Output Waveforms

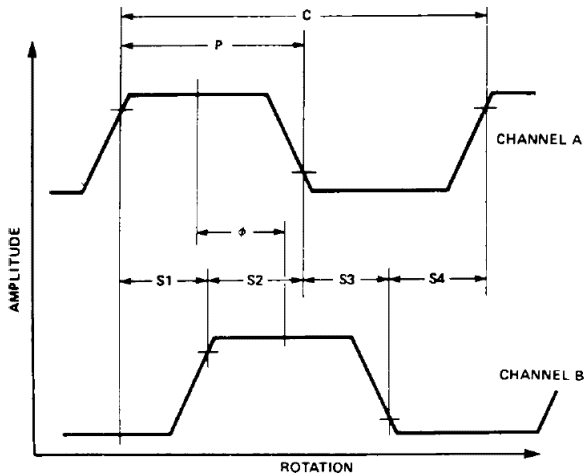

## Definitions

Count (N) = The number of bar and window pairs or counts per revolution (CPR) of the codewheel, or the number of lines per inch of the codestrip (LPI).

1 Shaft Rotation = 360 mechanical degrees  
= N cycles

1 cycle (c) = 360 electrical degrees (°e)  
= 1 bar and window pair

Pulse Width (P): The number of electrical degrees that an output is high during one cycle. This value is nominally 180°e or 1/2 cycle.

Pulse Width Error ( $\Delta P$ ): The deviation, in electrical degrees, of the pulse width from its ideal value of 180°e.

State Width (S): The number of electrical degrees between a transition in the output of channel A and the neighboring transition in the output of channel B. There are 4 states per cycle, each nominally 90°e.

State Width Error ( $\Delta S$ ): The deviation, in electrical degrees, of each state width from its ideal value of 90°e.

Phase ( $\phi$ ): The number of electrical degrees between the center of the high state of channel A and the center of the high state of channel B. This value is nominally 90°e for quadrature output.

Phase Error ( $\Delta\phi$ ): The deviation of the phase from its ideal value of 90°e.

Direction of Rotation: When the codewheel rotates counterclockwise, as viewed looking down on the module (so the marking is visible), channel A will lead channel B. If the codewheel rotates in the opposite direction, channel B will lead channel A.

Optical Radius (R<sub>op</sub>): The distance from the codewheel's center of rotation to the optical center (O.C.) of the encoder module.

Angular Misalignment Error (E<sub>A</sub>): angular misalignment of the sensor in relation to the tangential direction. This applies for both rotary and linear motion.

Mounting Position (R<sub>M</sub>): Distance from Motor Shaft center of rotation to center of Alignment Tab receiving hole.

## Absolute Maximum Ratings

Parameter	Symbol	Min.	Max.	Units	Notes
Storage Temperature	T <sub>S</sub>	-40	85	°C	Option A & Q
			70		All Other Options
Operating Temperature	T <sub>A</sub>	-40	85	°C	Option A & Q
			70		All Other Options
Supply Voltage	V <sub>CC</sub>	-0.5	7	V	
Output Voltage	V <sub>O</sub>	-0.5	V <sub>CC</sub>	V	
Output Current per Channel	I <sub>O</sub>	-1.0	5	mA	
Soldering Temperature			260	°C	t ≤ 5 sec.

## Recommended Operating Conditions

Parameter	Symbol	Min.	Typ.	Max.	Units	Notes
Temperature	T	-40		85	°C	Option A & Q
				70		All Other Options
Supply Voltage	V <sub>CC</sub>	4.5	5.0	5.5	V	Ripple < 100 mVp-p
Load Capacitance	C <sub>L</sub>			100	pF	3.2 kΩ pull-up
Count Frequency				40	kHz	(Velocity (rpm) x N)/60
Angular Misalignment	E <sub>A</sub>	-2.0	0.0	+2.0	deg.	
Mounting Position	R <sub>M</sub>		R <sub>OP</sub> -0.14		mm	 Shaft Ø 0.13 mm (0.005") See Mounting Considerations
			(R <sub>OP</sub> -0.006)		(inch)	

Note: The module performance is specified at 40 kHz but can operate at higher frequencies.

## Electrical Characteristics

Electrical Characteristics over Recommended Operating Range, Typical at 25°C.

Parameter	Symbol	Min.	Typ.	Max.	Units	Notes
Supply Current	I <sub>CC</sub>		17	40	mA	Option A & Q
			57	85		All Other Options
High Level Output Voltage	V <sub>OH</sub>	2.4			V	I <sub>OH</sub> = -200 μA
Low Level Output Voltage	V <sub>OL</sub>			0.4	V	I <sub>OL</sub> = 3.86 mA
Rise Time	t <sub>r</sub>		180		ns	C <sub>L</sub> = 25 pF, R <sub>L</sub> = 3.3 kΩ pull-up
Fall Time	t <sub>f</sub>		40		ns	

## Encoding Characteristics

Encoding Characteristics over Recommended Operating Condition and recommended mounting tolerances. These characteristics do not include codewheel/codestrip contribution. The Typical Values are averages over the full rotation of the codewheel. For operation above 40 kHz, see frequency derating curves.

Parameter	Symbol	Typical	Maximum	Units
Pulse Width Error	$\Delta P$	5	45	$^{\circ}e$
Logic State Width Error	$\Delta S$	3	45	$^{\circ}e$
Phase Error	$\Delta\phi$	2	15	$^{\circ}e$

Note: 3.3 k $\Omega$  pull-up resistors used on all encoder module outputs.

## Frequency Derating Curves

Typical performance over extended operating range. These curves were derived using a 25 pF load with a 3.3 k pull-up resistor. Greater load capacitances will cause more error than shown in these graphs.

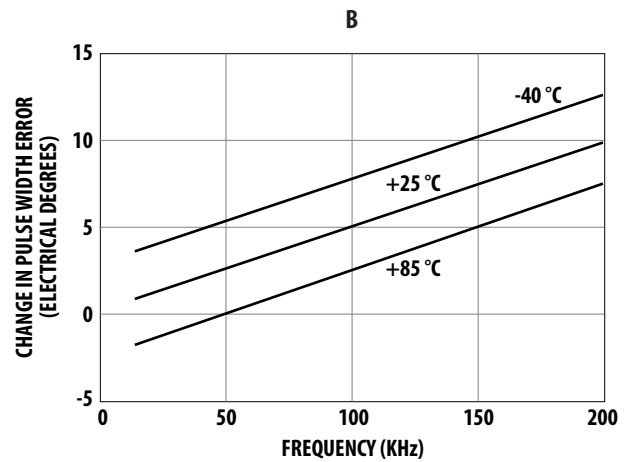
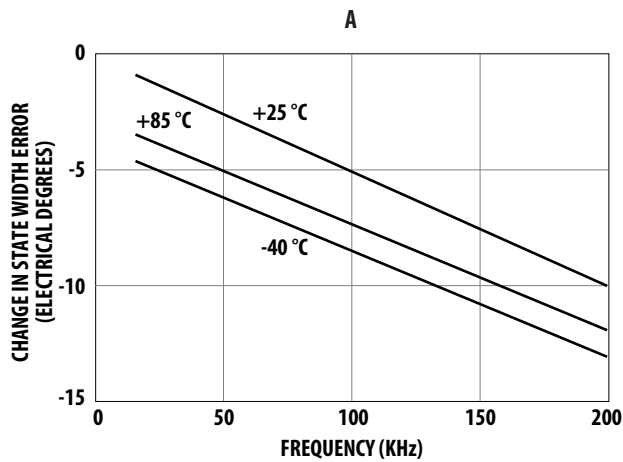

## Recommended Codewheel and Codestrip Characteristics

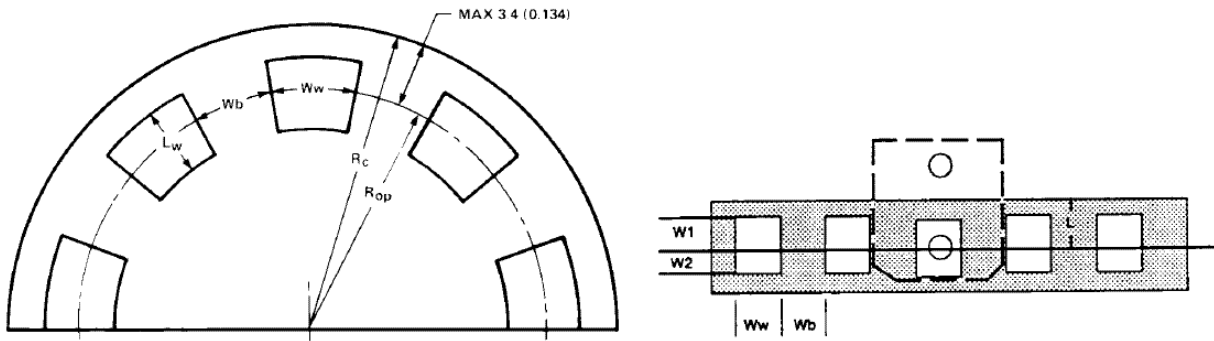

Parameter	Symbol	Min.	Max.	Units	Notes
Window/Bar Ratio	Ww/Wb	0.7	1.4		
Window Length (Rotary)	Lw	1.80 (0.071)	2.30 (0.091)	mm (inch)	
Absolute Maximum Codewheel Radius (Rotary)	Rc		Rop + 3.40 (Rop + 0.134)	mm (inch)	Includes eccentricity errors
Center of Post to Inside Edge of Window	W1	1.04 (0.041)		mm (inch)	
Center of Post to Outside Edge of Window	W2	0.76 (0.030)		mm (inch)	
Center of Post to Inside Edge of Codestrip	L		3.60 (0.142)	mm (inch)	

## Optional Packages Available

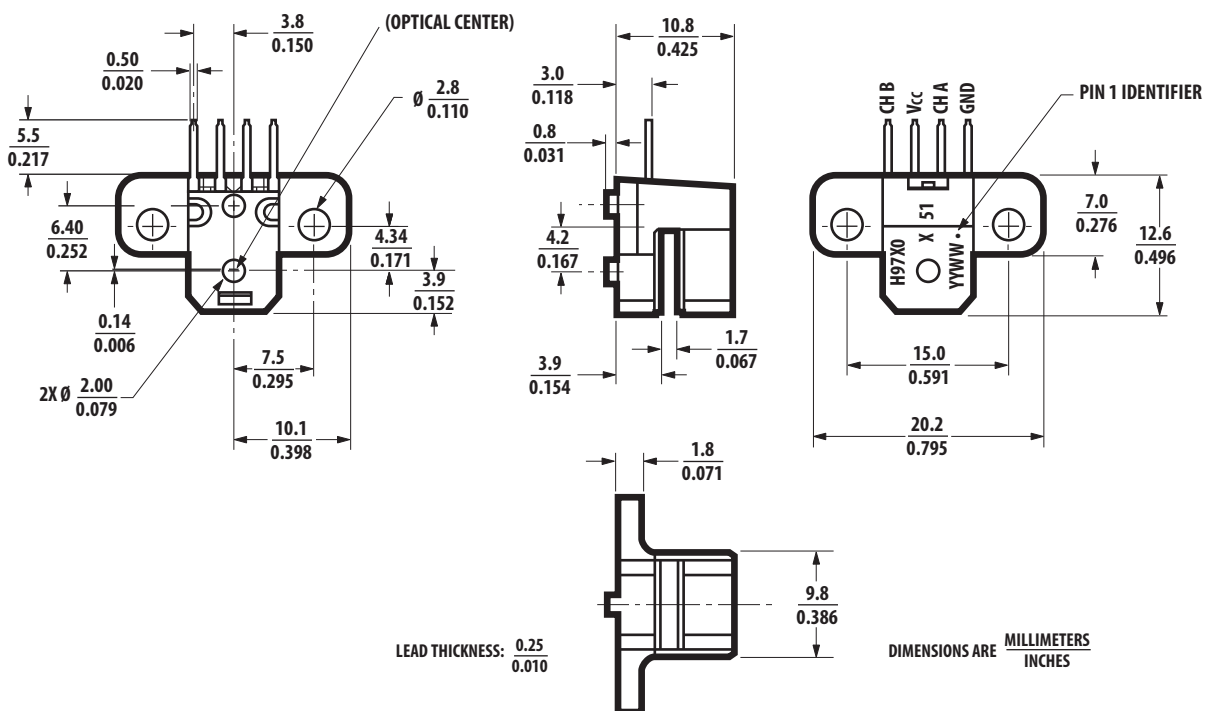

### Mounting Option #51 – Screwmount (Baseplane Mounting)

**Optional Packages Available (cont'd.)**

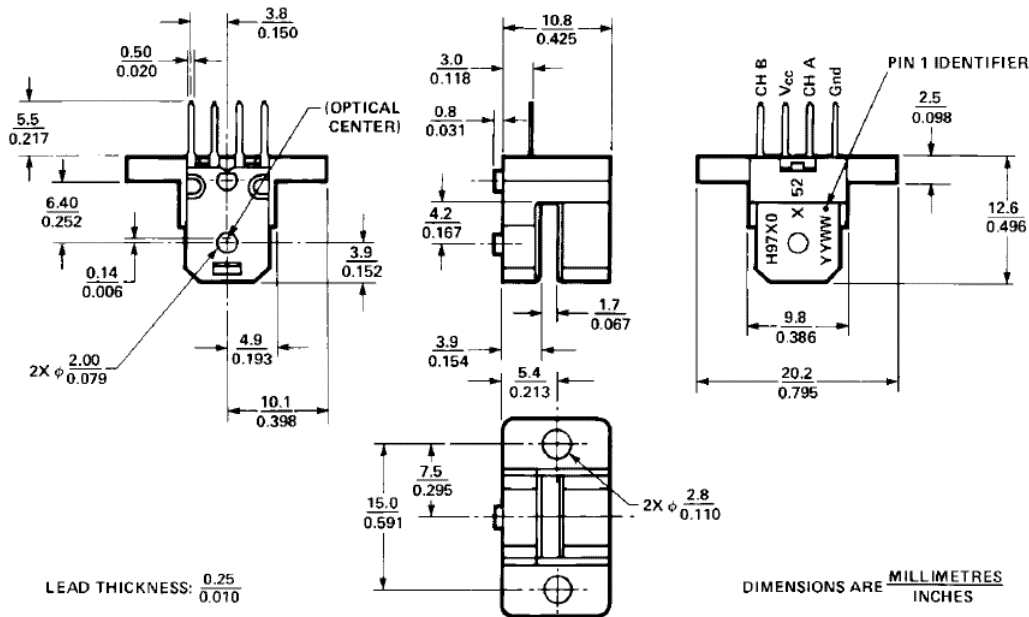

**Mounting Option #52 – Backplane (Backplane Mounting)**

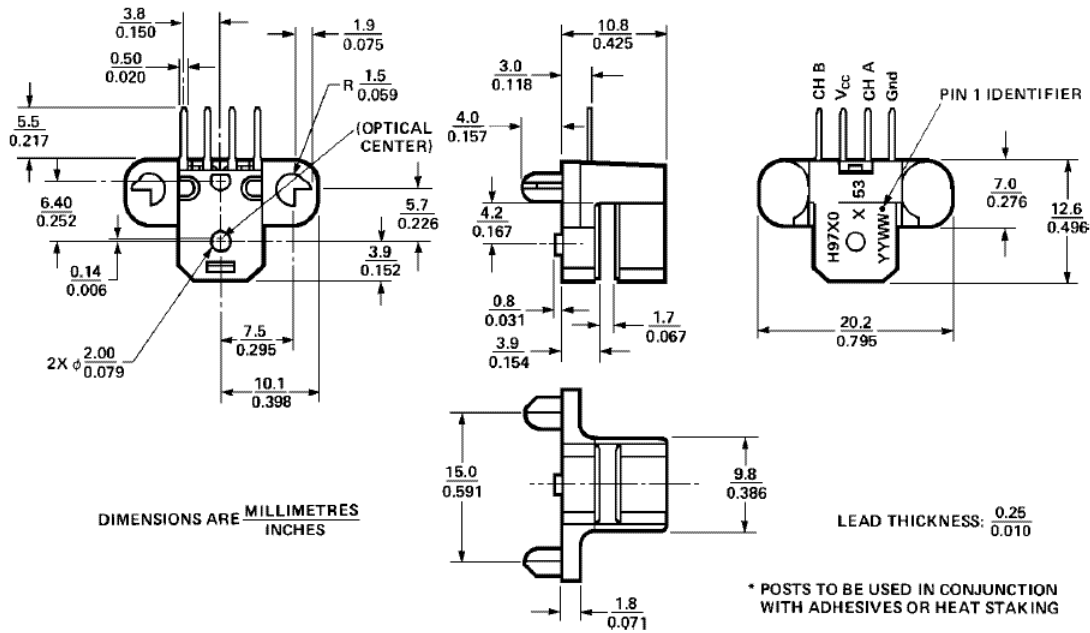

**Mounting Option #53 – Standard with Posts (Baseplane Mounting)**

**Optional Packages Available (cont'd.)**

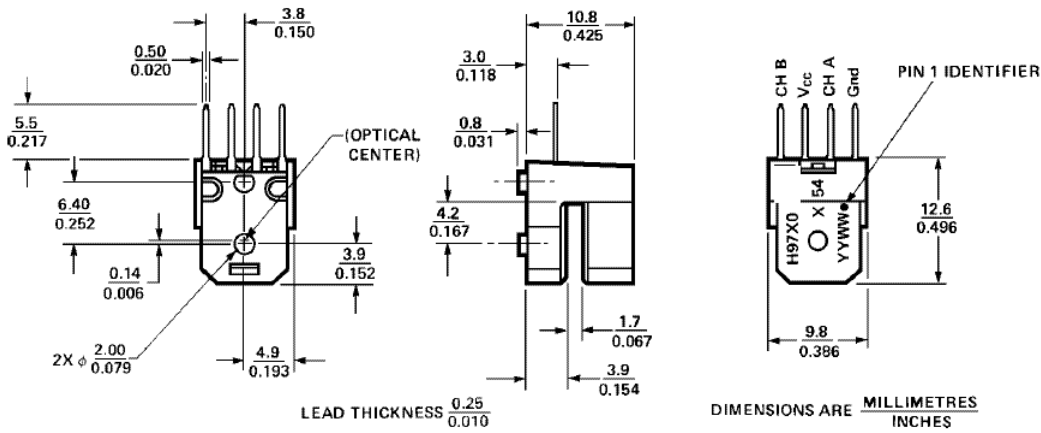

**Mounting Option #54 – Tabless (Baseplane Mounting)**

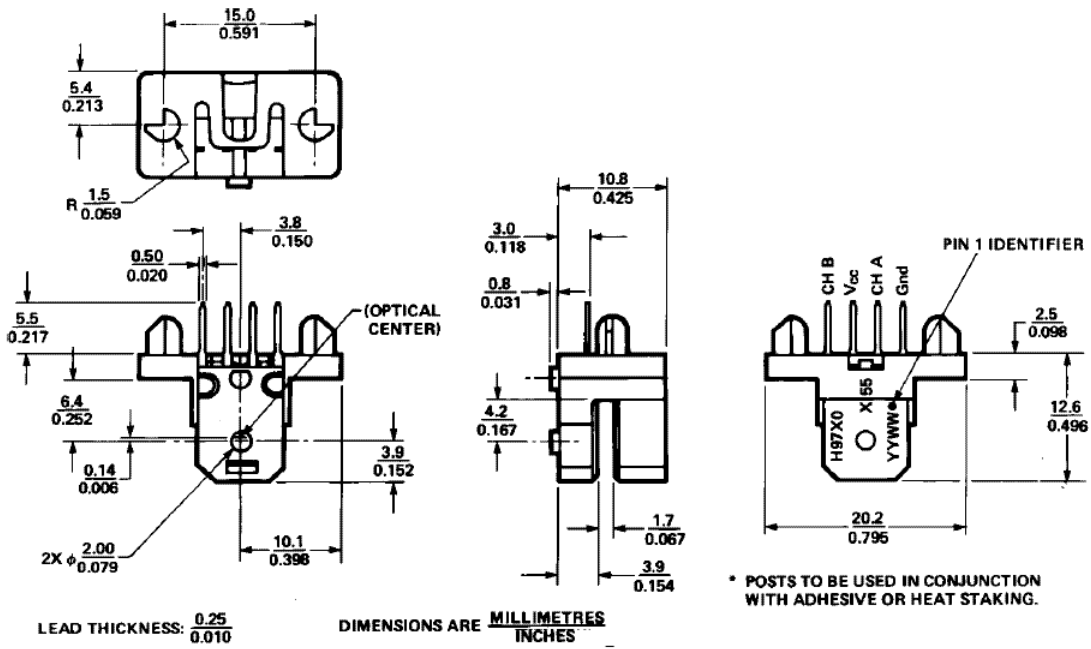

**Mounting Option #55 – Backplane with Posts (Backplane Mounting)**



## Bent Lead Option

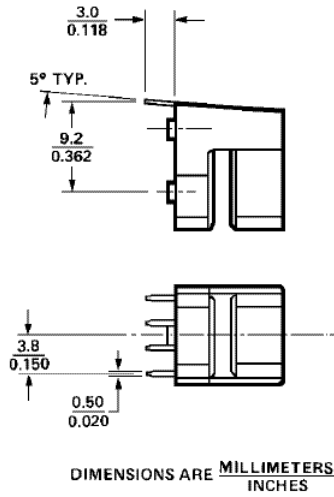

## Mounting Considerations

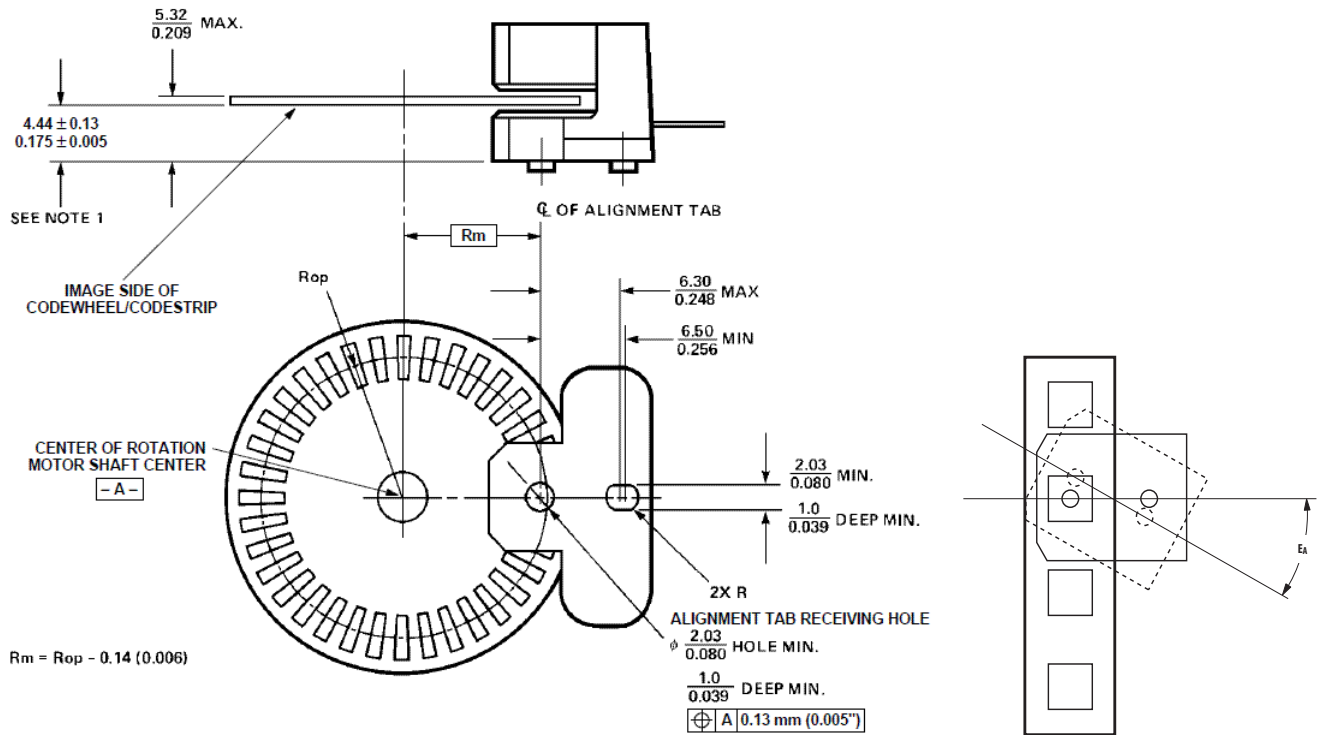

For linear motion, angular misalignment, EA, must be  $\pm 2$  degrees to achieve Encoding Characteristics.  
All dimensions for mounting the module and codestrip should be measured with respect to the two mounting posts, shown above.

Recommended Screw Size: M2.5 x 0.45 or 2-56

## Recommended Wave Solder Conditions

Flux – RMA Water Soluble (per MIL-F-14256D)

### Process Parameters

1. Flux
2. Pre-heat 60 seconds total  
Nominal preheat temp: 90°C  
Min: 85°C  
Max: 110°C
3. Solder Pot Zone  
Nominal dip in time:  
2.5 - 4.5 seconds  
Min: 2.5 seconds  
Max: 5 seconds  
PCB top side: 140 -160°C  
PCB bottom side: 240 - 260°C
4. Wave Solder 255°C, 1.2 meters/minute line speed
5. Hot Water Wash  
1st: 30°C 45 seconds  
2nd: 70°C 90 seconds
6. Rinse  
1st: 23°C 45 seconds  
2nd: 23°C 45 seconds
7. Dry  
1st: 80°C 105 seconds  
2nd: 95°C 105 seconds

## Ordering Information

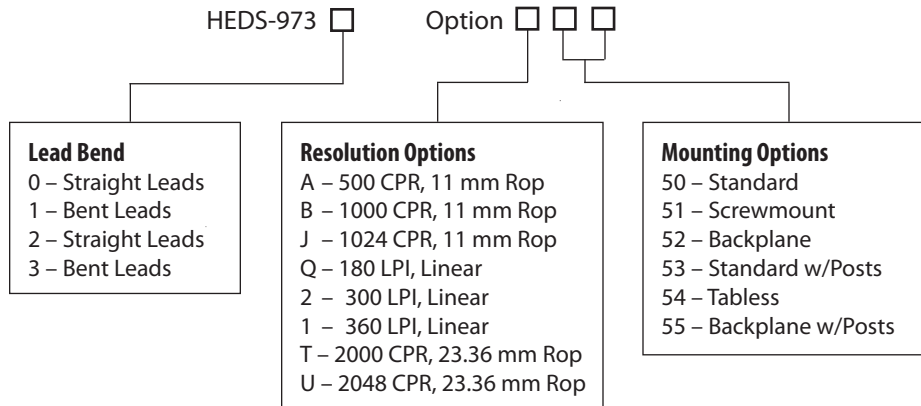

Note: Please contact factory for codewheel and codestrip information.

		50	51	52	53	54	55
HEDS-9730	A	*				*	
	Q	*		*			
	2	*					
	1						
	B						
	J						
HEDS-9731	A	*					
	Q	*					
	2	*	*	*	*	*	*
	1	*	*	*	*	*	*
	B	*	*	*	*	*	*
	J	*	*	*	*	*	*
HEDS-9732/33	T	*	*	*	*	*	*
	U	*	*	*	*	*	*

For product information and a complete list of distributors, please go to our web site: [www.avagotech.com](http://www.avagotech.com)

Avago, Avago Technologies, and the A logo are trademarks of Avago Technologies in the United States and other countries. Data subject to change. Copyright © 2005-2009 Avago Technologies. All rights reserved. Obsoletes 5988-8044EN AV02-1747EN - January 19, 2009

**AVAGO**  
TECHNOLOGIES