

CPC Connectors, Series 2 for Cable or Panel Mount

(Accepts Size 20 DM or DF Crimp, Snap-In Contacts)



Listed part numbers are for connectors only; **contacts must be ordered separately.**

Material

Housing—Thermoplastic, 94V-0 rated, black

Related Product Data

Contacts—Pages 28-29

Contact Arrangement—Page 30

Component Dimensions—Page 31*

Accessories—Pages 37-41

Performance Characteristics—Page 6

Application Tooling—Pages 75-78

Technical Documents—Page 79

Note: All part numbers are RoHS Compliant.

Circular Plastic Connectors, Series 2

Square Flange Receptacle

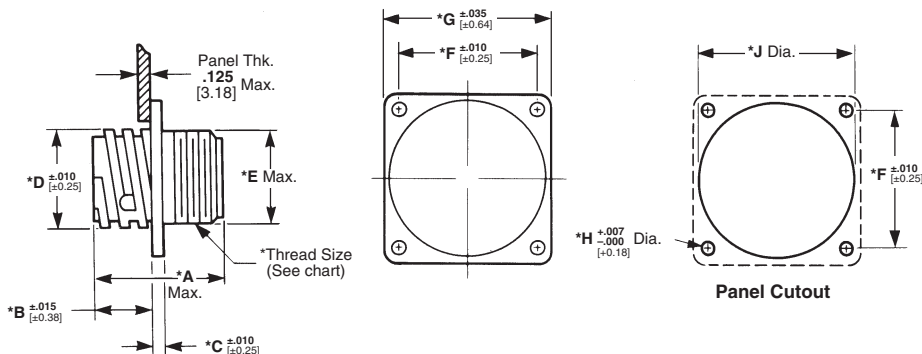

***Note:** See page 31 for callout dimensions

Free-Hanging Receptacle

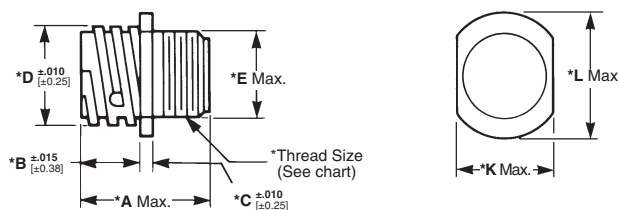

Plug

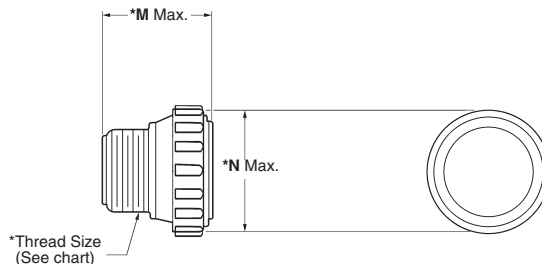

Standard Sex Connectors

(Receptacles accept Size 20 DM or DF pin contacts, Plugs accept Size 20 DM or DF socket contacts)

Arrangement	Square Flange Receptacle		Free-Hanging Receptacle	Plug
	With Mounting Holes	With Threaded Inserts ¹		
11-8	205841-1	205841-3	205841-2	205838-1
11-9	206486-1	206852-8	206486-2	206485-1
17-28	205840-3	205840-4	206152-1	205839-3
23-63	205843-1	—	205843-2	205842-1

¹Four 4-40 threaded inserts per receptacle.

Reverse Sex Connectors

(Receptacles accept Size 20 DM or DF socket contacts, Plugs accept Size 20 DM or DF pin contacts)

Arrangement	Square Flange Receptacle		Free-Hanging Receptacle	Plug
	With Mounting Holes	With Threaded Inserts ¹		
11-8	206433-1	206433-3	206433-2	206434-1
17-28	206038-1	206038-4	206038-2	206039-1
23-57	206438-1	—	206438-2	206437-1

¹Four 4-40 threaded inserts per receptacle.

Note: For Standard and Reverse Sex Connectors the maximum wire insulation diameter is .068 [1.73].

Receptacles, Printed Circuit Board Mount
with .025 [0.64] sq. solder tails



Note: All part numbers
are RoHS Compliant.

Circular Plastic Connectors, Series 2 (Continued)

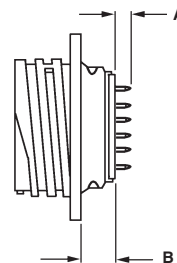
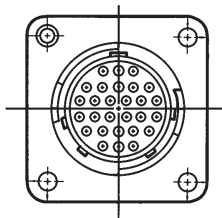

CPC
Series 2

Material and Finish

Housing—Thermoplastic, 94V-0 rated, black

Contacts

A—Duplex plated gold flash on entire contact with .000030 [0.00076] min. gold on contact engagement area, tin on the termination area, all over .000050 [0.00127] min. nickel underplating

B—Plated gold flash on the entire contact, tin on the termination area

Related Product Data

Contact Arrangement—Page 30

Performance Characteristics—Page 6

Technical Documents—Page 79

Accessories—Pages 37-41

Standard Sex (Posted Pin Contacts)

Arrangement		Receptacle Assemblies		Dimensions		Contact Finish Code
Shell Size	No. of Positions	Mounting Holes	4-40 Threaded Inserts ¹	A	B	
11-9		1-206852-2	—	.125 3.18	.230 5.84	A
		1-206852-1	—	.352 8.94	.230 5.84	A
17-28		1-207369-1	—	.125 3.18	.230 5.84	A
		1-207369-3	—	.352 8.94	.230 5.84	A
23-63		1-206455-2	—	.227 5.77	.338 8.59	A
		1-206455-1	—	.449 11.40	.338 8.59	A

¹Four 4-40 threaded inserts per receptacle.

Reverse Sex (Posted Socket Contacts)

Arrangement		Receptacle Assemblies		Dimensions		Contact Finish Code
Shell Size	No. of Positions	Mounting Holes	4-40 Threaded Inserts ¹	A	B	
11-8		1-208657-1	—	.352 8.94	.285 7.24	A
		—	1-208657-0	.574 14.58	.230 7.24	A
17-28		1-207216-6	—	.125 3.18	.230 5.84	B
		1-207216-7	—	.352 8.94	.230 5.84	A
23-57		1-796329-1	—	.232 5.89	.333 8.46	A

¹Four 4-40 threaded inserts per receptacle.

Other Available Posted Contacts

Tyco Electronics can make available contacts with various solder tail lengths for loading into the standard or reverse sex, square flange receptacles for applications requiring custom solder tail lengths.

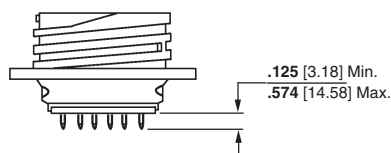

Special CPC Connectors, Series 2

(Pressure rated up to 30 psi)



Listed plug connector part numbers are for connectors only; **contacts must be ordered separately.**

Material

Housing—Thermoplastic, 94V-0 rated, black

Feed-Thru Contacts—Copper alloy, plated gold over nickel

Related Product Data

Socket Contacts (for Plugs)—Pages 28-29

Contact Arrangement—Page 30

Performance Characteristics—Page 6

Accessories—Pages 37-41

Technical Documents—Page 79

Circular Plastic Connectors, Series 2 (Continued)

Square Flange Feed-Thru Receptacles

(with Permanently Sealed .040 [1.02] Dia. Solid Pins)

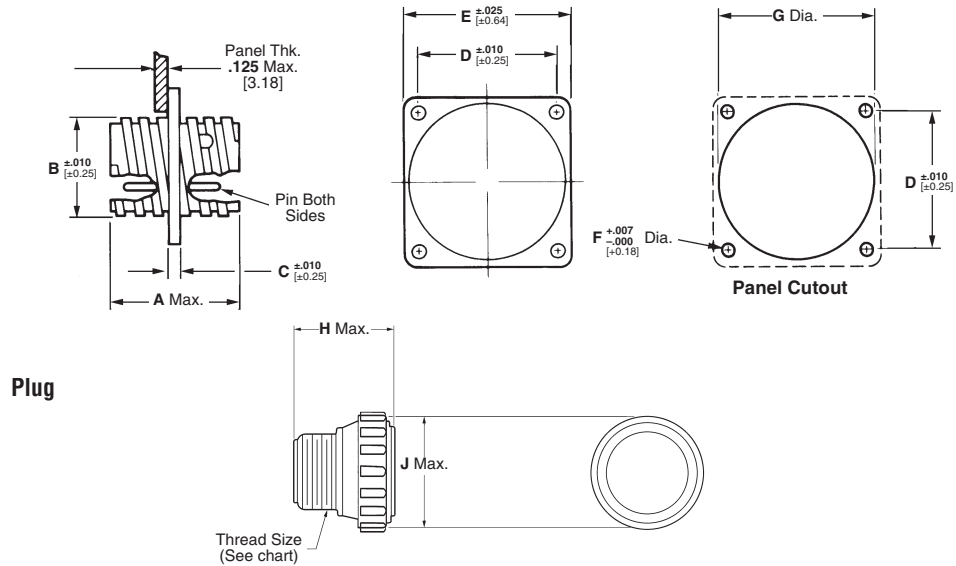

CPC Series 2

Arrangement No.	Dimensions									Thread Size
	A	B	C	D	E	F	G	H	J	
11-8	1.035 26.29	.688 17.48	.188 4.78	.844 21.44	1.125 28.58	.125 3.18	.840 21.34	.800 20.32	.975 24.77	5/8-24 UNEF-2A
17-28	1.040 26.42	1.050 26.67	.188 4.78	1.125 28.58	1.435 36.45	.150 3.81	1.210 30.73	.800 20.32	1.349 34.26	15/16-20 UNEF-2A

Part Numbers

Arrangement No.	Standard Numbering Plug	Reverse Numbering Plug	Square Flange Feed-Thru Receptacle
11-8	205838-1	206460-1	206458-1
17-28	206125-1	206126-1	206127-1

Note: One plug must have standard numbering of cavities, and the other plug must have reverse numbering of cavities.

Size 20 DF, Precision Formed, Crimp Contacts

Contact Size—20

Pin Diameter—.040 [1.02]

***Test Current**—7.5 ampere
(Single contact, free-air test current; not to be construed as contact rating current. Use only for testing.)

***Note:** Total current capacity of each contact in any given connector is dependent on the heat rise resulting from the combination of electrical loads of all contacts in the connector arrangement and the maximum ambient temperature in which the connector will be operating. See page 8.

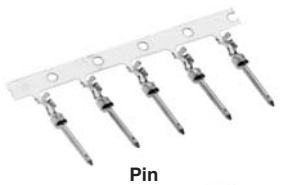

Pin



Socket

Material

Pin Body—Brass

Socket—Phosphor bronze

Contact Finish

A—Select gold flash over nickel on entire contact, with additional .000030 [0.00076] gold on mating end

B—Duplex plated .000030 [0.00076] gold on mating end, tin on termination end, with entire contact nickel underplated

C—Gold flash over nickel on entire contact

D—Duplex plated gold flash on mating end, tin on termination end, with entire contact nickel underplated

Related Product Data

Application Tooling—Pages 75-78

Technical Documents—Page 79

Product Specification—108-40005

Insertion/Extraction Tool

Part No. 91285-1

Instruction Sheet—408-9404

This tool includes interchangeable tips to Insert/Extract:

Size 22, 28-22 AWG

[0.08-0.03 mm²] Crimp Contacts

Size 20, 28-20 AWG [0.08-0.6 mm²]

Crimp and Solder Cup Contacts

Size 20, Posted Contacts

Signal Contacts

With Insulation Support

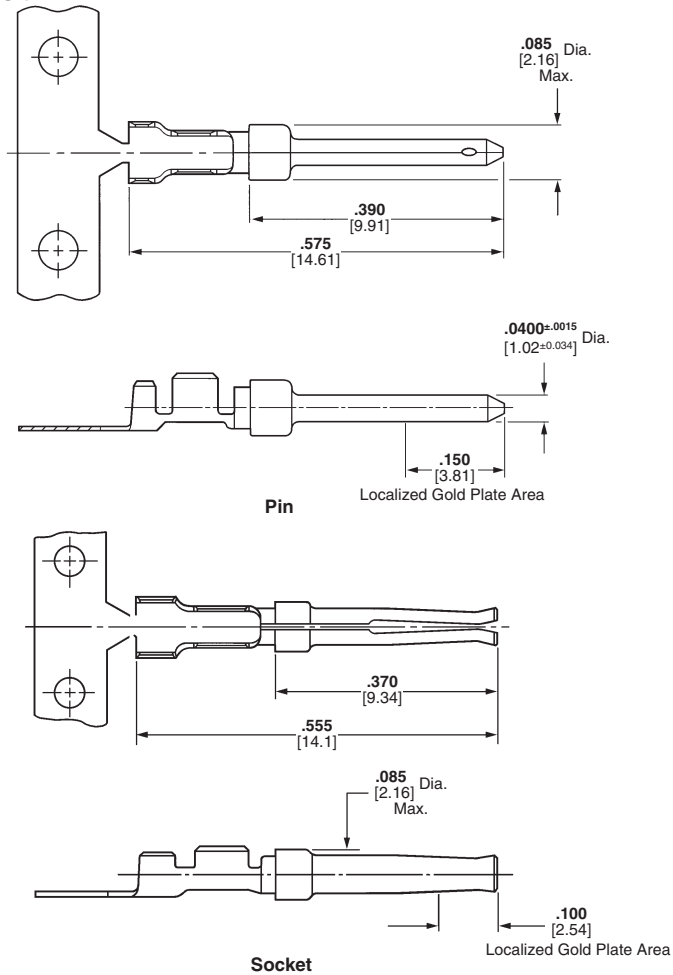

Wire Size Range	Ins. Dia. Max.	Contact Code Finish	Contact Part Nos.				Tooling		Color Code (Loose Piece)
			Pin		Socket		Strip Form Applicator††	Hand Tool	
			Strip Form	Loose Piece	Strip Form	Loose Piece			
28-24 AWG [0.08-0.2 mm ²]	1.02	A	66507-3	66507-9	66505-3	66505-9	466423-□†† or 466901-1†† or 1016015-1††	91503-1 ⁵	Blue Dot
		B	1658540-4	1658540-5	1658538-2	—			
		C	66507-4	1-66507-0	66505-4	1-66505-0			
		D	1658540-1	1658540-2	1658538-3	5-66505-9			
26-22 AWG [0.12-0.4 mm ²]	1.27	A	66682-2	66682-4	66683-2	66683-4	466758-2†† or 466963-1†† or 567804-1††	91549-1 ⁵	Black Dot
		B	5066682-9	—	1-5066683-0	—			
		C	745254-3	745254-7	745253-3	745253-7			
		D	1658544-3	1-745254-6	1658543-3	1-745253-6			
24-20 AWG [0.2-0.6 mm ²]	1.52	A	66506-3	66506-9	66504-3	66504-9	466422-□†† or 466900-1†† or 567801-1†† or 1016002-1††	91503-1 ⁵	Red Dot
		B	1658539-1	1658539-3	1658537-3	1658537-4			
		C	66506-4	1-66506-0	66504-4	1-66504-0			
		D	1658539-2	1658539-4	1658537-1	1658537-2			

†To use with the 626 Pneumatic Tool System: remove the crimping head from the Straight Action Hand Tool (SAHT) Assembly, order SAHT Adapter **Part No. 217201-1**, Adapter Holder **Part No. 356304-1** (with ratchet) or **189928-1** (without), and Power Unit **Part No. 189721-1** (hand actuated) or **189722-1** (foot actuated).

††For complete information on AMP Strip Form Applicators for fully automatic and semiautomatic machines, contact Technical Support.

Note: Commercial PRO-CRIMPER III Maintenance and Repair Hand Tool for Wire Size 28-24 AWG [0.08-0.2 mm²] (Ins. Dia. Max. .040 [1.02]), and Wire Size 24-20 AWG [0.2-0.6 mm²] (Ins. Dia. Max. .060 [1.52])—**Part No. 58448-2**.

Note: Die Set **Part No. 58448-3** can be adapted for use with the 626 Pneumatic Tool System.

Size 20 DM, Screw-Machined, Crimp Contacts

Pin Diameter—.040 [1.02]

Test Current*—7.5 amperes (Single contact, free-air test current; not to be construed as contact rating current. Use only for testing.)

Material and Finish

Pin Body—Copper alloy per QQ-B-626

Socket Body—Beryllium copper per QQ-C-530

Socket Sleeve—Passivated stainless steel per QQ-S-766

Plating pin and socket body—.000050-.000100 [0.00127-0.00254] min. gold over .000100-.000150 [0.00254-0.00381] min. copper

Gold plating per MIL-G-45204
Copper plating per MIL-C-14550

Type 20 DF, Solder Contacts

Pin Diameter—.040 [1.02]

Test Current*—7.5 amperes (Single contact, free-air test current; not to be construed as contact rating current. Use only for testing.)

Material and Finish

Pin—Brass, plated gold flash over nickel on entire contact with additional .000030 [0.00076] min. gold on mating end

Socket—Phosphor bronze, plated gold flash over nickel on entire contact with additional .000030 [0.00076] min. gold on mating end

***Note:** Total current capacity of each contact in a given connector is dependent on the heat rise resulting from the combination of electrical loads of all contacts in the connector arrangement and the maximum ambient temperature in which the connector will be operating. See page 8.

Signal Contacts (Continued)

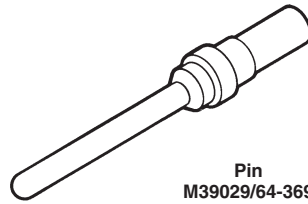

Pin
M39029/64-369
(Supersedes M24308/11-1)

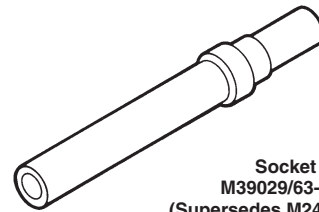

Socket
M39029/63-368
(Supersedes M24308/10-1)

Wire Size Range ¹ AWG mm ²	Ins. Dia. (Max.)	Contact Configuration	Tape Mounted Contacts ²	Loose Piece Contacts		Hand Tool Nos.		Positioner Nos.	
			Part No.	Military No. (M39029)	Part No.	Military (M22520)	Part No.	Military (M22520)	Part No.
24-20	0.2-0.6	.068 1.73	Pin 205089-2	64-369	205089-1	02-01	601966-1	2-08	601966-5
			Socket 205090-2	63-368	205090-1				

¹Overall insulation crimp diameter, including crimp barrel, must not exceed .125 [3.18].
².000015 [0.00038] gold in the mating area over .000050 [0.00127] nickel.

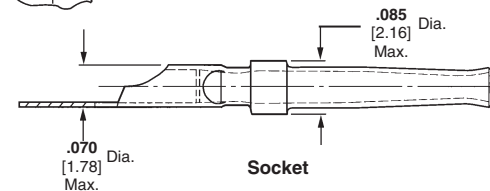
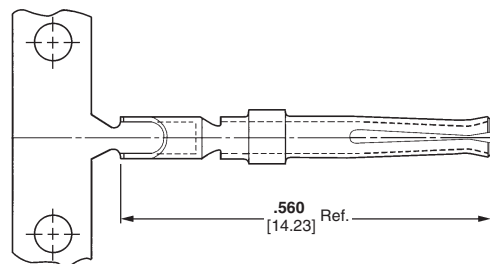
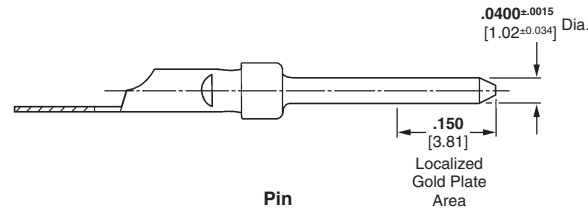
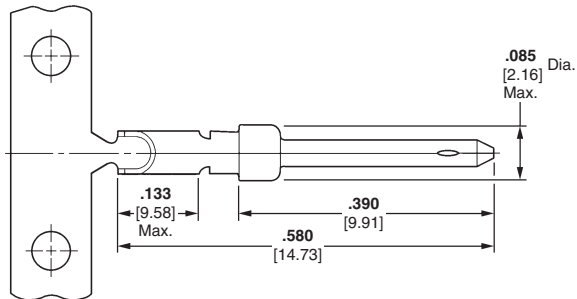

Strip Form Contact No.		Loose Piece Contact No.	
Pin	Socket	Pin	Socket
66570-2	66569-2	66570-3	66569-3

Note: Contacts to be soldered to wire before being inserted into housing, 18 AWG [0.8 - 0.9 mm²] max. wire size.

Note: Contact arrangements shown are of pin mating face (plug or receptacle). Socket mating face is mirror image.

Contact Arrangements, Series 2

Shell Size 11

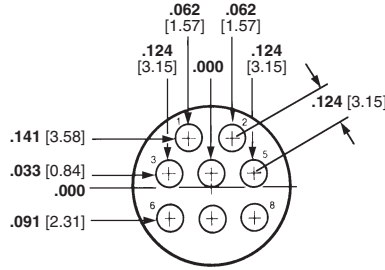

Arrangement 11-8
Max. Wire Ins. Dia. = .068 [1.73]

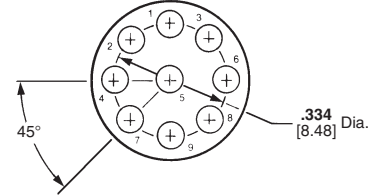

Arrangement 11-9
Max. Wire Ins. Dia. = .068 [1.73]

Shell Size 17

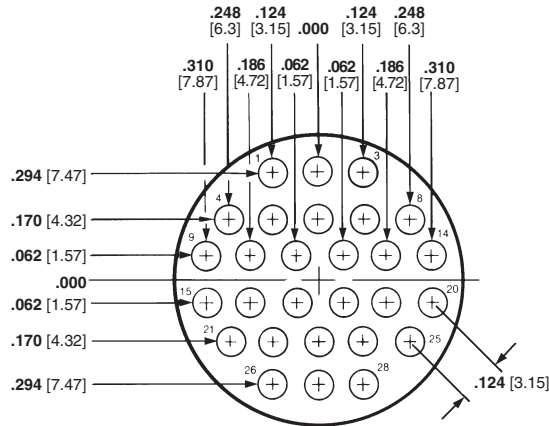

Arrangement 17-28
Max. Wire Ins. Dia. = .068 [1.73]

Shell Size 23

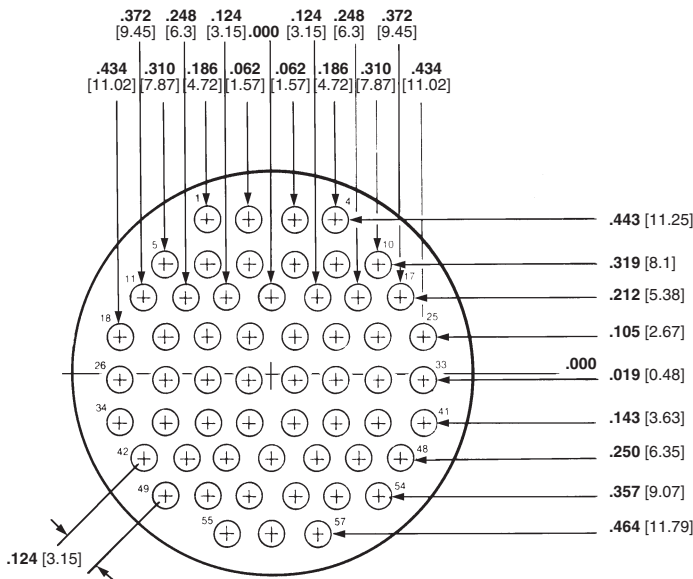

Arrangement 23-57
Max. Wire Ins. Dia. = .068 [1.73]

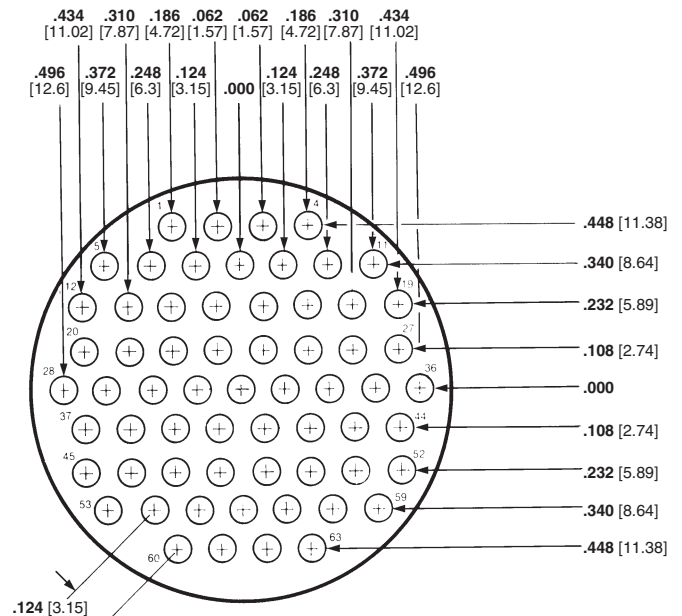

Arrangement 23-63
Max. Wire Ins. Dia. = .068 [1.73]

CPC Series 2

Component Dimensions, Series 2

Square Flange Receptacle

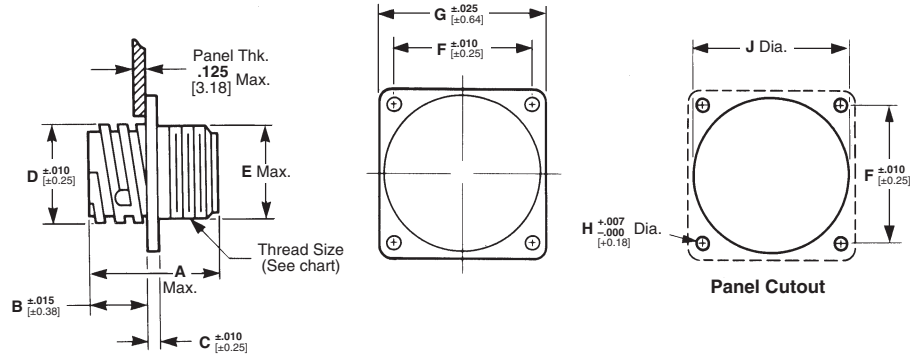

Free-Hanging Receptacle

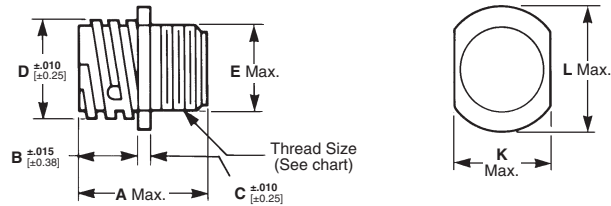

Plug

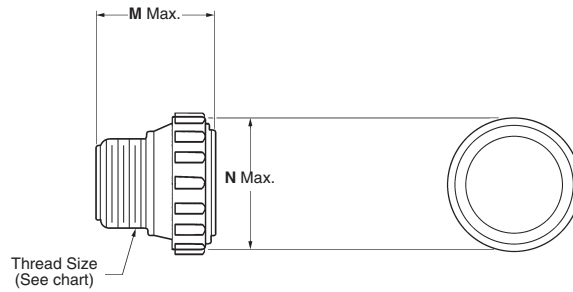

Arrangement No.	Dimensions												Thread Size	
	A	B	C	D	E	F	G	H	J	K	L	M		N
11-8	.809	.420	.094	.688	.630	.844	1.125	.125	.840	.817	.935	.800	.975	5/8-24
11-9	20.55	10.67	2.39	17.48	16	21.44	28.58	3.18	21.34	20.75	23.75	20.32	24.77	UNEF-2A
17-28	.809	.420	.094	1.050	.943	1.125	1.435	.150	1.210	1.161	1.310	.800	1.349	15/16-20
	20.55	10.67	2.39	26.67	23.95	28.58	36.45	3.81	30.73	29.49	33.27	20.32	34.26	UNEF-2A
23-57	.924	.420	.156	1.438	1.515	1.438	1.750	.150	1.610	1.500	1.733	.915	1.788	1-3/8-18
23-63	23.47	10.67	3.96	36.53	38.48	36.53	44.45	3.81	40.89	38.1	44.02	23.24	45.42	UNEF-2A

Note: All dimensions apply to both standard and reverse sex connectors.