

# HDSM-281x/283x

0.28" (7.0mm)

Single digit surface mount LED display



## Data Sheet

### Description

The HDSM-281x/283x is a single digit display of 0.28" (7.0mm) height. This device utilizes AlInGaP / GaAs chips and has a grey top surface with white segments.

### Features

- 0.28" digit height
- Low current operation
- Excellent characters appearance
- Available in CA and CC
- 1000 pieces per reel
- Moisture sensitivity level: Level 3
- RoHS compliant

### Ordering Information

| Red       | Green     | Yellow    | Orange    | Description                             |
|-----------|-----------|-----------|-----------|---|
| HDSM-281C | HDSM-281H | HDSM-281F | HDSM-281L | Common Anode, Upper and Lower Decimal   |
| HDSM-283C | HDSM-283H | HDSM-283F | HDSM-283L | Common Cathode, Upper and Lower Decimal |

### Package Dimensions

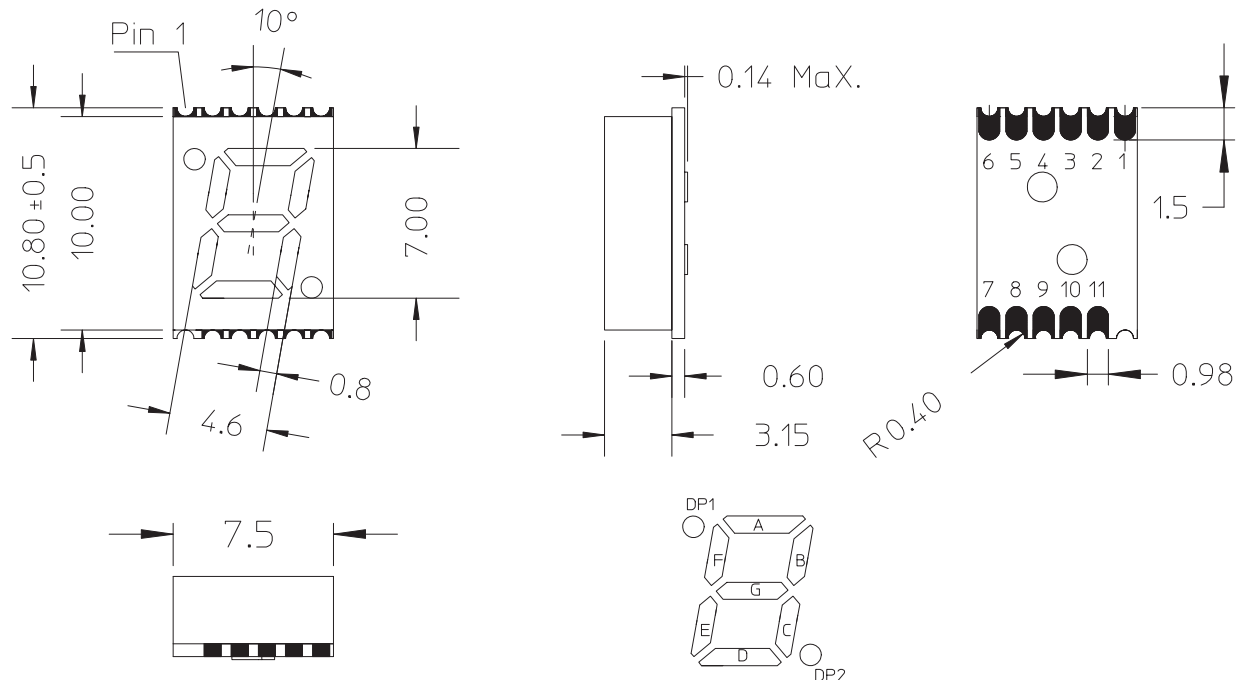

#### Notes:

All dimensions are in millimeters (inches).

Tolerance: ± 0.25mm (0.01") unless otherwise noted.

### Pin Connection (Common Anode)

| PIN No | Connection   |
|--------|--------------|
| 1      | CATHODE G    |
| 2      | CATHODE DP1  |
| 3      | CATHODE F    |
| 4      | COMMON ANODE |
| 5      | CATHODE A    |
| 6      | CATHODE B    |
| 7      | CATHODE DP2  |
| 8      | CATHODE C    |
| 9      | COMMON ANODE |
| 10     | CATHODE D    |
| 11     | CATHODE E    |

### Pin Connection (Common Cathode)

| PIN No | Connection     |
|--------|----------------|
| 1      | ANODE G        |
| 2      | ANODE DP1      |
| 3      | ANODE F        |
| 4      | COMMON CATHODE |
| 5      | ANODE A        |
| 6      | ANODE B        |
| 7      | ANODE DP2      |
| 8      | ANODE C        |
| 9      | COMMON CATHODE |
| 10     | ANODE D        |
| 11     | ANODE E        |

### Internal Circuit Diagram (Common Anode)

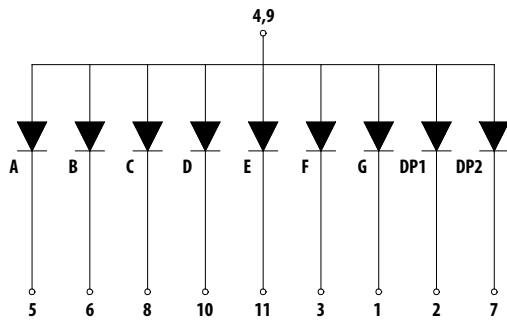

### Internal Circuit Diagram (Common Cathode)

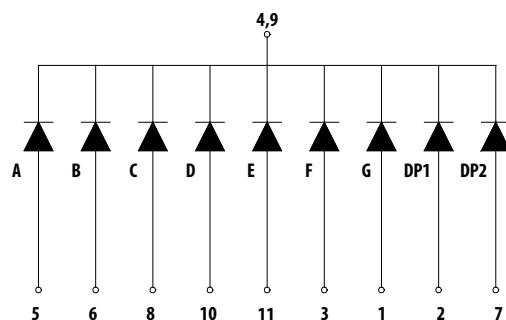

### Absolute Maximum Ratings @ $T_A=25^\circ$

| Parameter   | Green/Yellow/Red/Orange | Unit        |
|---|-------------------------|-------------|
| Power Dissipation Per Segment   | 65                      | mW          |
| Peak Forward Current Per Segment<br>(1/10 Duty Cycle, 0.1ms pulse width)          | 100                     | mA          |
| Continuous Forward Current Per Segment<br>Derating Linearly From 25°C Per Segment | 25<br>0.25              | mA<br>mA/°C |
| Reverse Voltage Per Segment   | 5                       | V           |
| Operating Temperature Range   | -40°C to +105°C         |             |
| Storage Temperature Range   | -40°C to +105°C         |             |

## Electrical / Optical Characteristics @ T<sub>A</sub>=25°C

### Green

| Parameters                        | Symbol                         | Min | Typ     | Max | Unit | Test Condition        |
|-----------------------------------|--------------------------------|-----|---------|-----|------|-----------------------|
| Average Luminous Intensity        | I <sub>V</sub>                 | 3.4 | 6       | -   | mcd  | I <sub>F</sub> = 10mA |
| Emissions Wavelength              | η <sub>p</sub> /λ <sub>d</sub> | -   | 572/571 | -   | nm   | I <sub>F</sub> = 20mA |
| Spectral Line Half-Width          | Δλ                             | -   | 20      | -   | nm   | I <sub>F</sub> = 20mA |
| Forward Voltage, Per Segment      | V <sub>F</sub>                 | -   | 2.1     | 2.6 | V    | I <sub>F</sub> = 20mA |
| Reverse Current, Per Segment      | I <sub>R</sub>                 | -   | -       | 100 | μA   | V <sub>R</sub> = 5V   |
| Luminous Intensity Matching Ratio | I <sub>V-M</sub>               | -   | -       | 2:1 | -    | I <sub>F</sub> = 10mA |

### Yellow

| Parameters                        | Symbol                         | Min | Typ     | Max | Unit | Test Condition        |
|-----------------------------------|--------------------------------|-----|---------|-----|------|-----------------------|
| Average Luminous Intensity        | I <sub>V</sub>                 | 3.4 | 8.0     | -   | mcd  | I <sub>F</sub> = 10mA |
| Emissions Wavelength              | λ <sub>p</sub> /λ <sub>d</sub> | -   | 591/589 | -   | nm   | I <sub>F</sub> = 20mA |
| Spectral Line Half-Width          | Δλ                             | -   | 15      | -   | nm   | I <sub>F</sub> = 20mA |
| Forward Voltage, Per Segment      | V <sub>F</sub>                 | -   | 2.1     | 2.6 | V    | I <sub>F</sub> = 20mA |
| Reverse Current, Per Segment      | I <sub>R</sub>                 | -   | -       | 100 | μA   | V <sub>R</sub> = 5V   |
| Luminous Intensity Matching Ratio | I <sub>V-M</sub>               | -   | -       | 2:1 | -    | I <sub>F</sub> = 10mA |

### Red

| Parameters                        | Symbol                         | Min | Typ     | Max | Unit | Test Condition        |
|-----------------------------------|--------------------------------|-----|---------|-----|------|-----------------------|
| Average Luminous Intensity        | I <sub>V</sub>                 | 3.4 | 7.5     | -   | mcd  | I <sub>F</sub> = 10mA |
| Emissions Wavelength              | λ <sub>p</sub> /λ <sub>d</sub> | -   | 632/624 | -   | nm   | I <sub>F</sub> = 20mA |
| Spectral Line Half-Width          | Δλ                             | -   | 20      | -   | nm   | I <sub>F</sub> = 20mA |
| Forward Voltage, Per Segment      | V <sub>F</sub>                 | -   | 2.0     | 2.6 | V    | I <sub>F</sub> = 20mA |
| Reverse Current, Per Segment      | I <sub>R</sub>                 | -   | -       | 100 | μA   | V <sub>R</sub> = 5V   |
| Luminous Intensity Matching Ratio | I <sub>V-M</sub>               | -   | -       | 2:1 | -    | I <sub>F</sub> = 10mA |

### Orange

| Parameters                        | Symbol                         | Min | Typ     | Max | Unit | Test Condition        |
|-----------------------------------|--------------------------------|-----|---------|-----|------|-----------------------|
| Average Luminous Intensity        | I <sub>V</sub>                 | 3.4 | 8.5     | -   | mcd  | I <sub>F</sub> = 10mA |
| Emissions Wavelength              | λ <sub>p</sub> /λ <sub>d</sub> | -   | 611/605 | -   | nm   | I <sub>F</sub> = 20mA |
| Spectral Line Half-Width          | Δλ                             | -   | 20      | -   | nm   | I <sub>F</sub> = 20mA |
| Forward Voltage, Per Segment      | V <sub>F</sub>                 | -   | 2.1     | 2.6 | V    | I <sub>F</sub> = 20mA |
| Reverse Current, Per Segment      | I <sub>R</sub>                 | -   | -       | 100 | μA   | V <sub>R</sub> = 5V   |
| Luminous Intensity Matching Ratio | I <sub>V-M</sub>               | -   | -       | 2:1 | -    | I <sub>F</sub> = 10mA |

Typical Electrical / Optical characteristic curves @  $T_A=25^\circ\text{C}$

Green



Figure 1. Relative Luminous Intensity vs. Wavelength



Figure 2. Relative Luminous Intensity vs. Forward Current



Figure 3. Allowable DC Current vs. Ambient Temperature



Figure 4. Forward Current vs. Forward Voltage

## Yellow

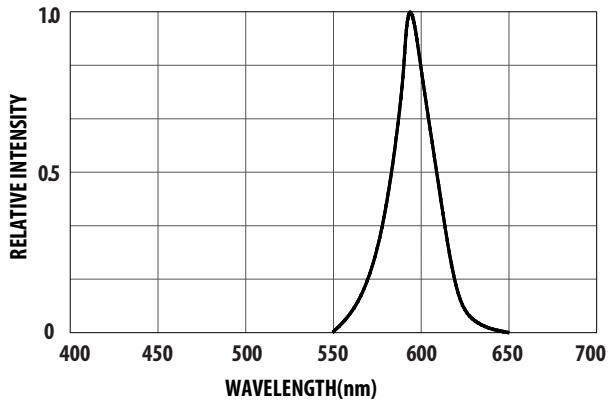

Figure 1. Relative Intensity vs. Wavelength

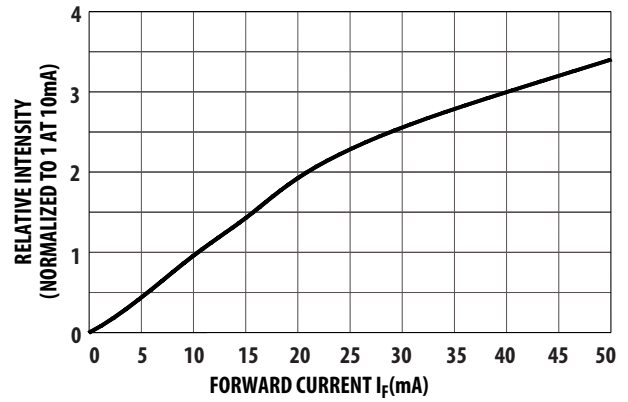

Figure 2. Relative Intensity vs. Forward Current

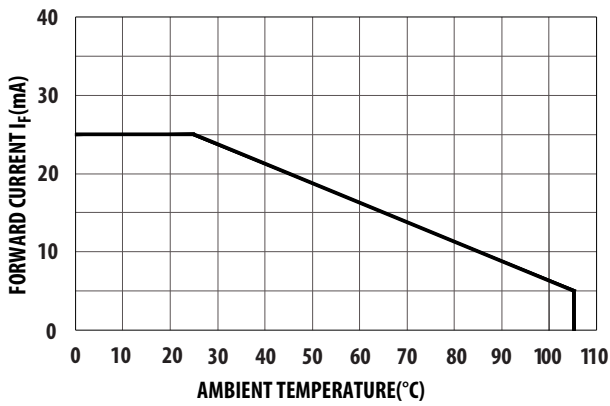

Figure 3. Allowable DC Current vs. Ambient Temperature

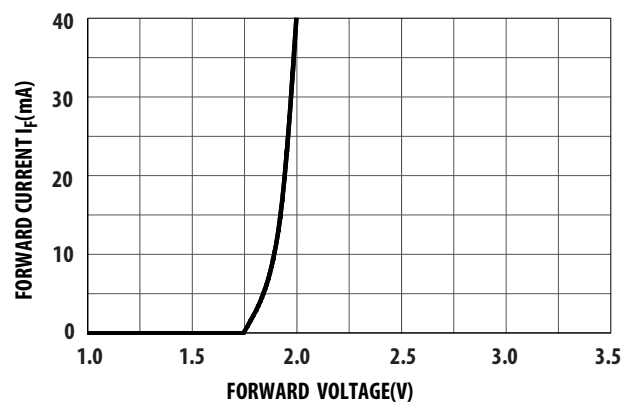

Figure 4. Forward Current vs. Forward Voltage

Red

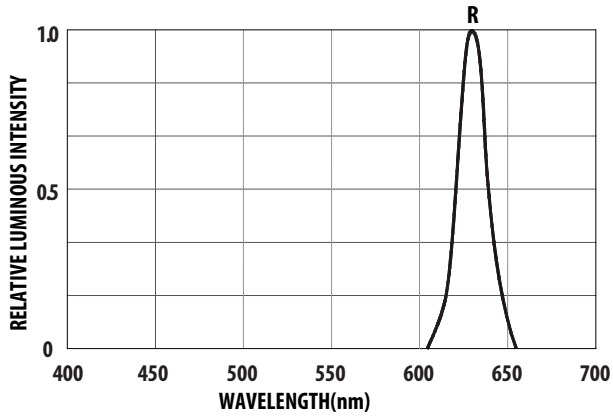

Figure 1. Relative Luminous Intensity vs. Wavelength

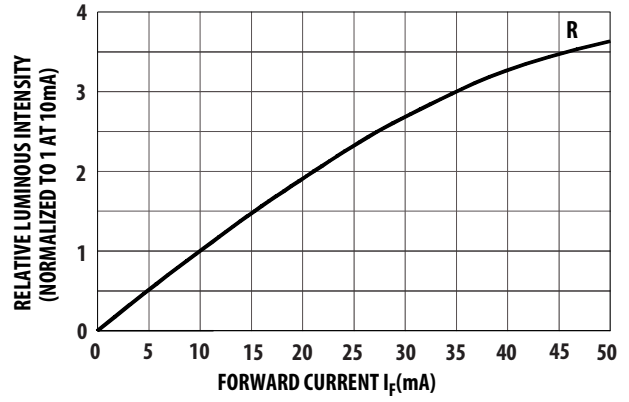

Figure 2. Relative Luminous Intensity vs. Forward Current

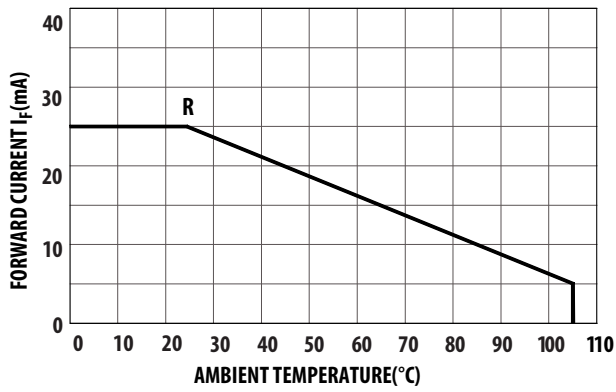

Figure 3. Allowable DC Current vs. Ambient Temperature

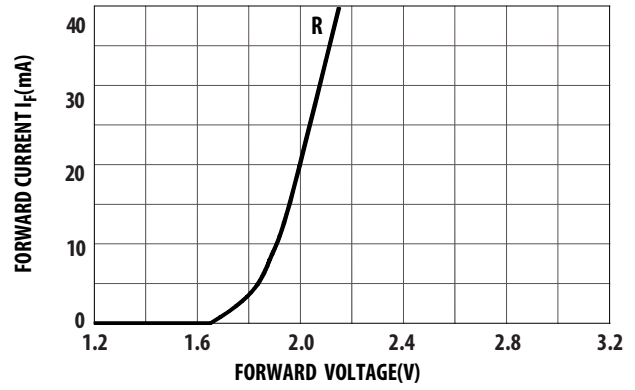

Figure 4. Forward Current vs. Forward Voltage

## Orange



Figure 1. Relative Intensity vs. Wavelength

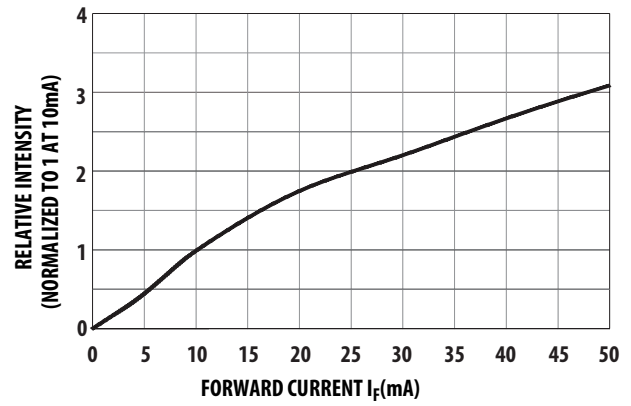

Figure 2. Relative Intensity vs. Forward Current

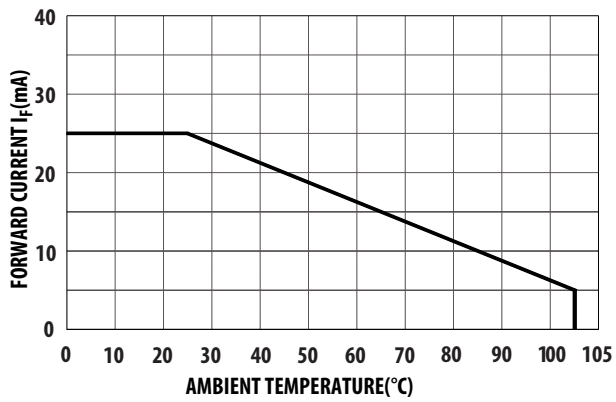

Figure 3. Allowable DC Current vs. Ambient Temperature

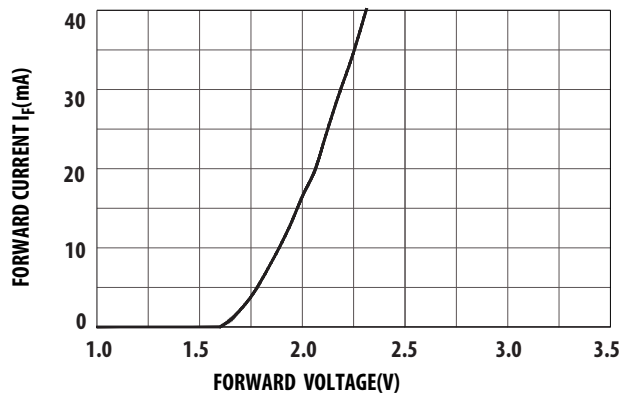

Figure 4. Forward Current vs. Forward Voltage

## Intensity Bin Limits (mcd)

### Yellow / Red / Orange / Green

| IV Bin Category | Min.   | Max    |
|-----------------|--------|--------|
| L               | 3.401  | 5.400  |
| M               | 5.401  | 8.600  |
| N               | 8.601  | 13.700 |
| P               | 13.701 | 21.800 |

Tolerance:  $\pm 15\%$

Notes:

1. Bin categories are established for classification of products. Products may not be available in all categories. Please contact your Avago representative for information on currently available bins.

## SMT Soldering Profile

### Pb free reflow soldering Profile

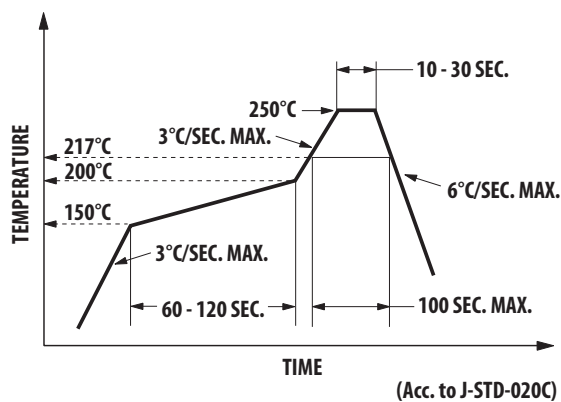

Notes:

1. The peak temperature refers to the peak package body temperature.
2. Number of reflow process shall be limited to maximum 2 times only. Cooling process to normal temperature is required between first and second soldering process.

## Recommended soldering pattern (unit: mm)

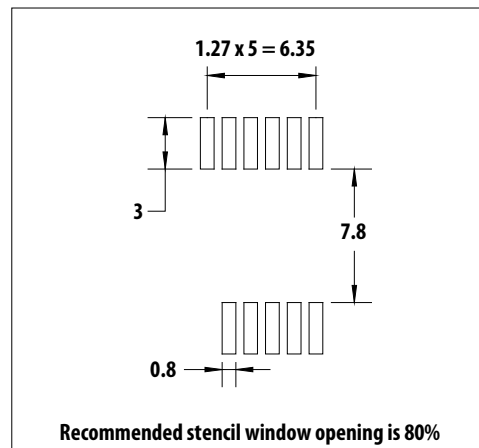



## Tape specification (unit: mm)

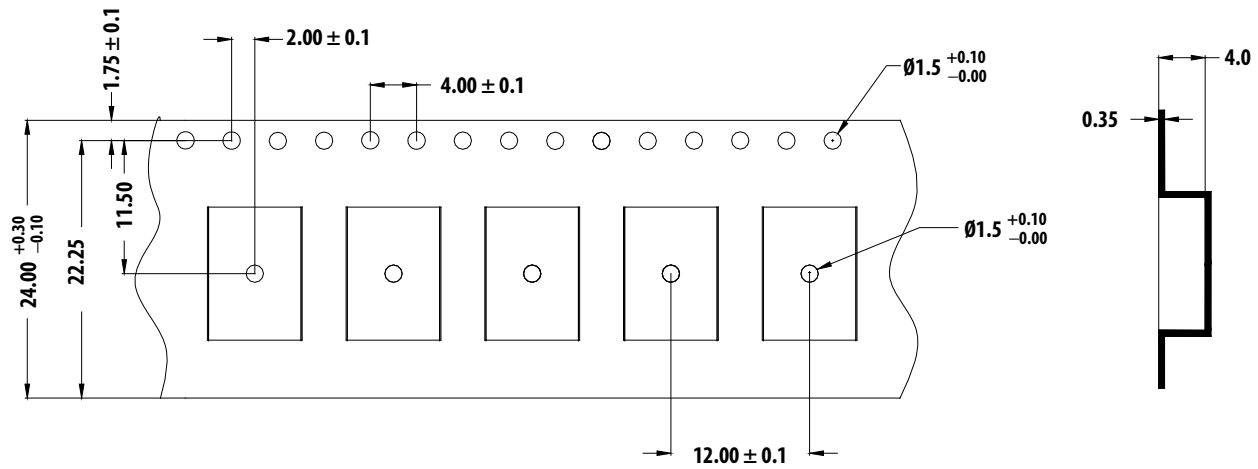

For product information and a complete list of distributors, please go to our web site: [www.avagotech.com](http://www.avagotech.com)

Avago, Avago Technologies, and the A logo are trademarks of Avago Technologies in the United States and other countries.  
Data subject to change. Copyright © 2005-2011 Avago Technologies. All rights reserved.  
AV02-0980EN - March 17, 2011

**AVAGO**  
TECHNOLOGIES