

SUBMINIATURE DB Series

Features

- High-precision switch with high repeat accuracy
- Models available for operating temperatures up to 120°C
- Rated for currents up to 10 amp at 250VAC
- Range of auxiliary actuators available (can also be retrofitted); two mounting positions
- Variety of contact materials available to suit your application
- Mechanical life: up to 15×10^6 operations
- Wide variety of terminal types available
- Numerous approvals

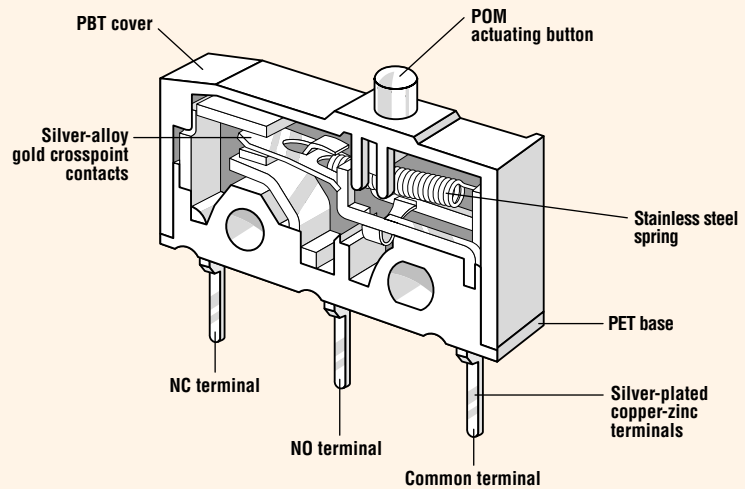

Electrical Ratings

Switch Series	EN61058 Rating	UL1054 Rating	Electrical Life at Rated Load	
			According to EN (Min. Operations)	According to UL (Min. Operations)
DB1	6A, 250V~	5A, 125/250VAC	10,000	6,000
DB2	10(1.5)A, 250V~	10.1A, 125/250VAC; 1/4HP, 125VAC	10,000	6,000
DB3	0.1A, 250V~	0.1A, 125/250VAC	50,000	6,000
DB5*	1A, 250V~	1A, 125/250VAC	50,000	6,000
DB6*	6A, 250V~	5A, 125/250VAC	50,000	6,000
DB7*	10(1.5A), 400V~	10.1A, 125/250VAC; 1/4HP, 125VAC	50,000	6,000

*85°C

Specifications

Electrical

Temperature Rating:	-40°C to +85°C / +120°C
Flammability Rating:	UL94V-O (PBT, PET) UL94HB (POM)

Materials

Base:	PET
Cover:	PBT
Actuator:	PBT, POM
Auxiliary Actuator:	Stainless Steel or Plastic
Terminals:	Silver-Plated Copper-Zinc
Contacts:	Silver Alloy Gold Crosspoint

PBT = Polybutyleneterephthalate • PET = Polyethyleneterephthalate • POM = Polyacetal



Dimensions inches (mm)

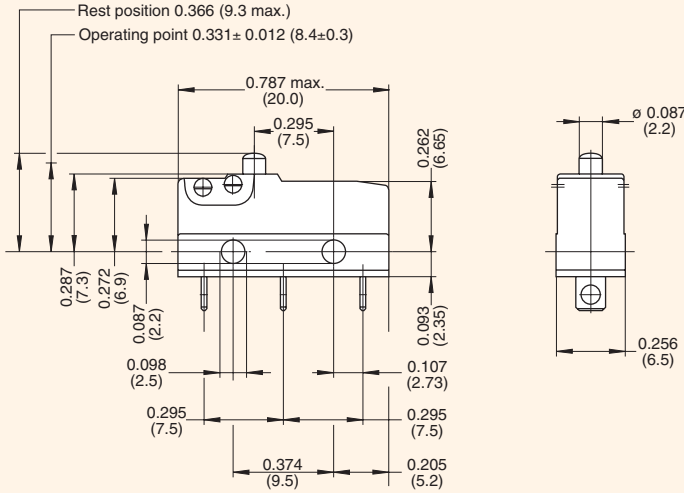

Terminal Options inches (mm)

QC Terminals
0.110 x 0.020 (2.8 x 0.5)

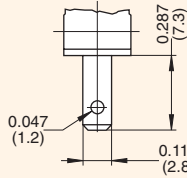

Solder Terminals – Short

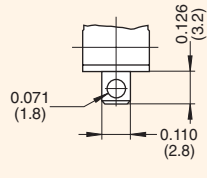

PCB Terminals – Straight
0.051 x 0.020 (1.3 x 0.5)

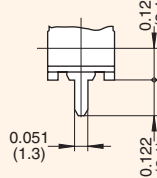

PCB Terminals – Straight
0.024 x 0.020 (0.6 x 0.5)

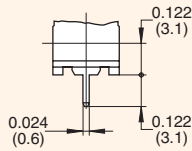

PCB Terminals RH Side w/o Location Pins
0.024 x 0.020 (0.6 x 0.5)

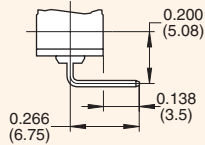

PCB Terminals LH Side w/o Location Pins
0.024 x 0.020 (0.6 x 0.5)

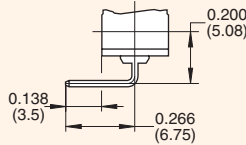

PCB Terminals RH Side with Location Pins
0.024 x 0.020 (0.6 x 0.5)

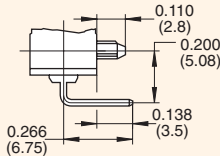

PCB Terminals LH Side with Location Pins
0.024 x 0.020 (0.6 x 0.5)

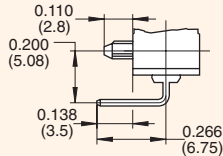

Top-down View of Lateral Terminals

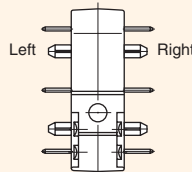

Drilling Patterns for PCB Terminals
0.051 x 0.020 (1.3 x 0.5)

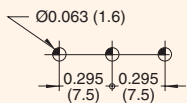

Drilling Patterns for PCB Terminals (Straight/Lateral w/o Location Pins)
0.024 x 0.020 (0.6 x 0.5)

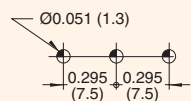

Drilling Patterns for PCB Terminals (Lateral with Location Pins)
0.024 x 0.020 (0.6 x 0.5)

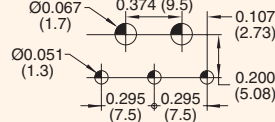



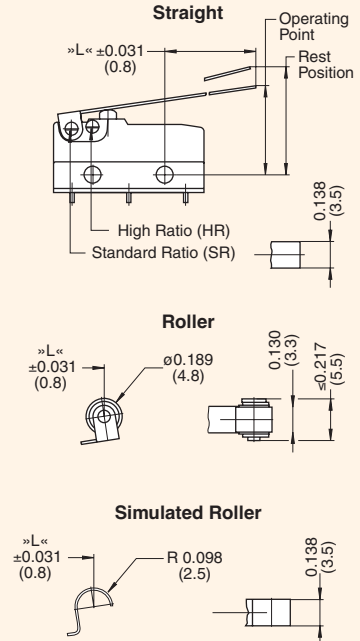











Auxiliary Actuator inches (mm)



Contact Ratings at Direct Voltage













Switching Voltage	Switched Current Resistive Load		Inductive Load L/R=3ms	
	DB1	DB2	DB1	DB2
12V	6A	10A	6A	10A
24V	3A	5A	2A	4A
60V	1A	1A	0.5A	0.5A
110V	0.5A	0.5A	0.2A	0.2A
220V	0.25A	0.25A	0.1A	0.1A

Actuator Specifications — Standard Ratio

Actuator Code	Switch Type	Maximum Operating Force (gms.)	Maximum Pre-Travel inches (mm)	Operating Point inches (mm)	Minimum Over-Travel inches (mm)	Max. Movement Differential inches (mm)	Max. Rest Position inches (mm)	Actuation Length inches (mm)	
AA		DB5	70	0.039 (1.0)	0.331±0.012 (8.4±0.3)	0.024 (0.6)	0.004 (0.10)	0.366 (9.3)	—
		DB1/3	150	0.039 (1.0)	0.331±0.012 (8.4±0.3)	0.024 (0.6)	0.004 (0.10)	0.366 (9.3)	—
		DB6	150	0.039 (1.0)	0.331±0.012 (8.4±0.3)	0.024 (0.6)	0.006 (0.15)	0.366 (9.3)	—
		DB2	250	0.039 (1.0)	0.331±0.012 (8.4±0.3)	0.024 (0.6)	0.004 (0.10)	0.366 (9.3)	—
		DB7	280	0.039 (1.0)	0.331±0.012 (8.4±0.3)	0.024 (0.6)	0.006 (0.15)	0.366 (9.3)	—
BA		DB5	70	0.039 (1.0)	0.331±0.012 (8.4±0.3)	0.024 (0.6)	0.004 (0.10)	0.366 (9.3)	—
		DB1/3	150	0.039 (1.0)	0.331±0.012 (8.4±0.3)	0.024 (0.6)	0.004 (0.10)	0.366 (9.3)	—
		DB6	250	0.039 (1.0)	0.331±0.012 (8.4±0.3)	0.024 (0.6)	0.006 (0.15)	0.366 (9.3)	—
		DB2	250	0.039 (1.0)	0.331±0.012 (8.4±0.3)	0.024 (0.6)	0.004 (0.10)	0.366 (9.3)	—
		DB7	280	0.039 (1.0)	0.331±0.012 (8.4±0.3)	0.024 (0.6)	0.006 (0.15)	0.366 (9.3)	—
<i>Auxiliary actuator, rear-mounted (RM)</i>									
LB		DB5	30	0.157 (4.0)	0.421±0.051 (10.7±1.3)	0.079 (2.0)	0.020 (0.5)	0.551 (14.0)	0.189 (4.8)
		DB1/3	60	0.157 (4.0)	0.421±0.051 (10.7±1.3)	0.079 (2.0)	0.020 (0.5)	0.551 (14.0)	0.189 (4.8)
		DB6	60	0.157 (4.0)	0.421±0.051 (10.7±1.3)	0.079 (2.0)	0.030 (0.75)	0.551 (14.0)	0.189 (4.8)
		DB2	100	0.177 (4.5)	0.421±0.063 (10.7±1.6)	0.059 (1.5)	0.028 (0.70)	0.551 (14.0)	0.189 (4.8)
		DB7	115	0.177 (4.5)	0.421±0.063 (10.7±1.6)	0.059 (1.5)	0.030 (0.75)	0.551 (14.0)	0.189 (4.8)
LC		DB5	25	0.177 (4.5)	0.437±0.059 (11.1±1.5)	0.079 (2.0)	0.024 (0.6)	0.591 (15.0)	0.276 (7.0)
		DB1/3	50	0.177 (4.5)	0.437±0.059 (11.1±1.5)	0.079 (2.0)	0.024 (0.6)	0.591 (15.0)	0.276 (7.0)
		DB6	50	0.177 (4.5)	0.437±0.059 (11.1±1.5)	0.079 (2.0)	0.047 (1.2)	0.591 (15.0)	0.276 (7.0)
		DB2	85	0.197 (5.0)	0.437±0.071 (11.1±1.8)	0.059 (1.5)	0.039 (1.0)	0.591 (15.0)	0.276 (7.0)
		DB7	100	0.197 (5.0)	0.437±0.071 (11.1±1.8)	0.059 (1.5)	0.047 (1.2)	0.591 (15.0)	0.276 (7.0)
LD		DB5	9	0.591 (15.0)	0.512±0.138 (13.0±3.5)	0.157 (4.0)	0.177 (4.5)	1.063 (27.0)	1.654 (42.0)
		DB1/3	18	0.591 (15.0)	0.512±0.138 (13.0±3.5)	0.157 (4.0)	0.177 (4.5)	1.063 (27.0)	1.654 (42.0)
		DB6	18	0.591 (15.0)	0.512±0.138 (13.0±3.5)	0.157 (4.0)	0.268 (6.8)	1.063 (27.0)	1.654 (42.0)
		DB2/7	—	—	—	—	—	—	on request
SB		DB5	30	0.157 (4.0)	0.630±0.051 (16.0±1.3)	0.079 (2.0)	0.020 (0.5)	0.748 (19.0)	0.098 (2.5)
		DB1/3	65	0.157 (4.0)	0.630±0.051 (16.0±1.3)	0.079 (2.0)	0.020 (0.5)	0.748 (19.0)	0.098 (2.5)
		DB6	65	0.157 (4.0)	0.630±0.051 (16.0±1.3)	0.079 (2.0)	0.043 (1.1)	0.748 (19.0)	0.098 (2.5)
		DB2	110	0.177 (4.5)	0.630±0.063 (16.0±1.6)	0.059 (1.5)	0.028 (0.7)	0.748 (19.0)	0.098 (2.5)
		DB7	125	0.177 (4.5)	0.630±0.063 (16.0±1.6)	0.059 (1.5)	0.043 (1.1)	0.748 (19.0)	0.098 (2.5)
SC		DB5	25	0.177 (4.5)	0.646±0.059 (16.4±1.5)	0.079 (2.0)	0.024 (0.6)	0.787 (20.0)	0.185 (4.7)
		DB1/3	55	0.177 (4.5)	0.646±0.059 (16.4±1.5)	0.079 (2.0)	0.024 (0.6)	0.787 (20.0)	0.185 (4.7)
		DB6	55	0.177 (4.5)	0.646±0.059 (16.4±1.5)	0.079 (2.0)	0.047 (1.2)	0.787 (20.0)	0.185 (4.7)
		DB2	95	0.197 (5.0)	0.646±0.071 (16.4±1.8)	0.059 (1.5)	0.039 (1.0)	0.787 (20.0)	0.185 (4.7)
		DB7	110	0.197 (5.0)	0.646±0.071 (16.4±1.8)	0.059 (1.5)	0.047 (1.2)	0.787 (20.0)	0.185 (4.7)
SD		DB5	9	0.591 (15.0)	0.720±0.138 (18.3±3.5)	0.157 (4.0)	0.177 (4.5)	1.260 (32.0)	1.563 (39.7)
		DB1/3	20	0.591 (15.0)	0.720±0.138 (18.3±3.5)	0.157 (4.0)	0.177 (4.5)	1.260 (32.0)	1.563 (39.7)
		DB6	20	0.591 (15.0)	0.720±0.138 (18.3±3.5)	0.157 (4.0)	0.268 (6.8)	1.260 (32.0)	1.563 (39.7)
		DB2/7	—	—	—	—	—	—	on request
RB		DB5	30	0.157 (4.0)	0.622±0.051 (15.8±1.3)	0.079 (2.0)	0.020 (0.5)	0.748 (19.0)	0.098 (2.5)
		DB1/3	65	0.157 (4.0)	0.622±0.051 (15.8±1.3)	0.079 (2.0)	0.020 (0.5)	0.748 (19.0)	0.098 (2.5)
		DB6	65	0.157 (4.0)	0.622±0.051 (15.8±1.3)	0.079 (2.0)	0.030 (0.75)	0.748 (19.0)	0.098 (2.5)
		DB2	110	0.177 (4.5)	0.622±0.063 (15.8±1.6)	0.059 (1.5)	0.028 (0.7)	0.748 (19.0)	0.098 (2.5)
		DB7	125	0.177 (4.5)	0.622±0.063 (15.8±1.6)	0.059 (1.5)	0.030 (0.75)	0.748 (19.0)	0.098 (2.5)
RC		DB5	25	0.177 (4.5)	0.638±0.059 (16.2±1.5)	0.079 (2.0)	0.024 (0.6)	0.787 (20.0)	0.185 (4.7)
		DB1/3	55	0.177 (4.5)	0.638±0.059 (16.2±1.5)	0.079 (2.0)	0.024 (0.6)	0.787 (20.0)	0.185 (4.7)
		DB6	55	0.177 (4.5)	0.638±0.059 (16.2±1.5)	0.079 (2.0)	0.047 (1.2)	0.787 (20.0)	0.185 (4.7)
		DB2	95	0.197 (5.0)	0.638±0.071 (16.2±1.8)	0.059 (1.5)	0.039 (1.0)	0.787 (20.0)	0.185 (4.7)
		DB7	110	0.197 (5.0)	0.638±0.071 (16.2±1.8)	0.059 (1.5)	0.047 (1.2)	0.787 (20.0)	0.185 (4.7)
RD		DB5	9	0.591 (15.0)	0.713±0.138 (18.1±3.5)	0.157 (4.0)	0.177 (4.5)	1.260 (32.0)	1.563 (39.7)
		DB1/3	20	0.591 (15.0)	0.713±0.138 (18.1±3.5)	0.157 (4.0)	0.177 (4.5)	1.260 (32.0)	1.563 (39.7)
		DB6	20	0.591 (15.0)	0.713±0.138 (18.1±3.5)	0.157 (4.0)	0.268 (6.8)	1.260 (32.0)	1.563 (39.7)
		DB2/7	—	—	—	—	—	—	on request
WB*		DB5	24	0.177 (4.5)	0.437±0.059 (11.1±1.5)	0.079 (2.0)	0.024 (0.6)	0.591 (15.0)	0.276 (7.0)
		DB1/3	50	0.177 (4.5)	0.437±0.059 (11.1±1.5)	0.079 (2.0)	0.024 (0.6)	0.591 (15.0)	0.276 (7.0)
		DB6	50	0.177 (4.5)	0.437±0.059 (11.1±1.5)	0.079 (2.0)	0.035 (0.9)	0.591 (15.0)	0.276 (7.0)
		DB2	85	0.177 (4.5)	0.437±0.059 (11.1±1.5)	0.079 (2.0)	0.024 (0.6)	0.591 (15.0)	0.276 (7.0)
		DB7	100	0.177 (4.5)	0.437±0.059 (11.1±1.5)	0.079 (2.0)	0.035 (0.9)	0.591 (15.0)	0.276 (7.0)
WC*		DB5	18	0.236 (6.0)	0.480±0.071 (12.2±1.8)	0.118 (3.0)	0.031 (0.8)	0.669 (17.0)	0.551 (14.0)
		DB1/3	38	0.236 (6.0)	0.480±0.071 (12.2±1.8)	0.118 (3.0)	0.031 (0.8)	0.669 (17.0)	0.551 (14.0)
		DB6	38	0.236 (6.0)	0.480±0.071 (12.2±1.8)	0.118 (3.0)	0.047 (1.2)	0.669 (17.0)	0.551 (14.0)
		DB2	63	0.236 (6.0)	0.480±0.071 (12.2±1.8)	0.118 (3.0)	0.031 (0.8)	0.669 (17.0)	0.551 (14.0)
		DB7	75	0.236 (6.0)	0.480±0.071 (12.2±1.8)	0.118 (3.0)	0.047 (1.2)	0.669 (17.0)	0.551 (14.0)
VB*		DB5	25	0.177 (4.5)	0.469±0.055 (11.9±1.4)	0.079 (2.0)	0.024 (0.6)	0.591 (15.0)	0.220 (5.6)
		DB1/3	55	0.177 (4.5)	0.469±0.055 (11.9±1.4)	0.079 (2.0)	0.024 (0.6)	0.591 (15.0)	0.220 (5.6)
		DB6	55	0.177 (4.5)	0.469±0.055 (11.9±1.4)	0.079 (2.0)	0.035 (0.9)	0.591 (15.0)	0.220 (5.6)
		DB2	90	0.177 (4.5)	0.469±0.055 (11.9±1.4)	0.079 (2.0)	0.024 (0.6)	0.591 (15.0)	0.220 (5.6)
		DB7	105	0.177 (4.5)	0.469±0.055 (11.9±1.4)	0.079 (2.0)	0.035 (0.9)	0.591 (15.0)	0.220 (5.6)
ZB*		DB5	25	0.177 (4.5)	0.630±0.055 (16.0±1.4)	0.059 (1.5)	0.024 (0.6)	0.748 (19.0)	0.205 (5.2)
		DB1/3	55	0.177 (4.5)	0.630±0.055 (16.0±1.4)	0.059 (1.5)	0.024 (0.6)	0.748 (19.0)	0.205 (5.2)
		DB6	55	0.177 (4.5)	0.630±0.055 (16.0±1.4)	0.059 (1.5)	0.035 (0.9)	0.748 (19.0)	0.205 (5.2)
		DB2	90	0.177 (4.5)	0.630±0.055 (16.0±1.4)	0.059 (1.5)	0.024 (0.6)	0.748 (19.0)	0.205 (5.2)
		DB7	105	0.177 (4.5)	0.630±0.055 (16.0±1.4)	0.059 (1.5)	0.035 (0.9)	0.748 (19.0)	0.205 (5.2)

*For 85°C only

Actuator Specifications — High Ratio

Actuator Code	Switch Type	Maximum Operating Force (gms.)	Maximum Pre-Travel inches (mm)	Operating Point inches (mm)	Minimum Over-Travel inches (mm)	Max. Movement Differential inches (mm)	Max. Rest Position inches (mm)	Actuation Length inches (mm)
<i>Auxiliary actuator, front-mounted (FM)</i>								
	MB DB5	12	0.354 (9.0)	0.472±0.098 (12.0±2.5)	0.138 (3.5)	0.047 (1.2)	0.709 (18.0)	0.276 (7.0)
	DB1/3	25	0.354 (9.0)	0.472±0.098 (12.0±2.5)	0.138 (3.5)	0.047 (1.2)	0.709 (18.0)	0.276 (7.0)
	DB6	25	0.354 (9.0)	0.472±0.098 (12.0±2.5)	0.138 (3.5)	0.071 (1.8)	0.709 (18.0)	0.276 (7.0)
	DB2	40	0.354 (9.0)	0.472±0.118 (12.0±3.0)	0.138 (3.5)	0.059 (1.5)	0.709 (18.0)	0.276 (7.0)
	DB7	45	0.354 (9.0)	0.472±0.118 (12.0±3.0)	0.138 (3.5)	0.071 (1.8)	0.709 (18.0)	0.276 (7.0)
	MC DB5	10	0.394 (10.0)	0.492±0.118 (12.5±3.0)	0.157 (4.0)	0.055 (1.4)	0.787 (20.0)	0.370 (9.4)
	DB1/3	22	0.394 (10.0)	0.492±0.118 (12.5±3.0)	0.157 (4.0)	0.055 (1.4)	0.787 (20.0)	0.370 (9.4)
	DB6	22	0.394 (10.0)	0.492±0.118 (12.5±3.0)	0.157 (4.0)	0.083 (2.1)	0.787 (20.0)	0.370 (9.4)
	DB2	35	0.394 (10.0)	0.492±0.138 (12.5±3.5)	0.157 (4.0)	0.071 (1.8)	0.787 (20.0)	0.370 (9.4)
	DB7	40	0.394 (10.0)	0.492±0.138 (12.5±3.5)	0.157 (4.0)	0.083 (2.1)	0.787 (20.0)	0.370 (9.4)
	MD DB5	4	1.063 (27.0)	0.709±0.315 (18.0±8.0)	0.394 (10.0)	0.236 (6.0)	1.575 (40.0)	1.713 (43.5)
	DB1/3	9	1.063 (27.0)	0.709±0.315 (18.0±8.0)	0.394 (10.0)	0.236 (6.0)	1.575 (40.0)	1.713 (43.5)
	DB6	9	1.063 (27.0)	0.709±0.315 (18.0±8.0)	0.394 (10.0)	0.354 (9.0)	1.575 (40.0)	1.713 (43.5)
	DB2/7	—	—	—	—	—	—	on request
	UB DB5	14	0.354 (9.0)	0.677±0.098 (17.2±2.5)	0.138 (3.5)	0.047 (1.2)	0.866 (22.0)	0.185 (4.7)
	DB1/3	30	0.354 (9.0)	0.677±0.098 (17.2±2.5)	0.138 (3.5)	0.047 (1.2)	0.866 (22.0)	0.185 (4.7)
	DB6	30	0.354 (9.0)	0.677±0.098 (17.2±2.5)	0.138 (3.5)	0.071 (1.8)	0.866 (22.0)	0.185 (4.7)
	DB2	50	0.354 (9.0)	0.677±0.118 (17.2±3.0)	0.138 (3.5)	0.059 (1.5)	0.866 (22.0)	0.185 (4.7)
	DB7	56	0.354 (9.0)	0.677±0.118 (17.2±3.0)	0.138 (3.5)	0.071 (1.8)	0.866 (22.0)	0.185 (4.7)
	UC DB5	12	0.394 (10.0)	0.697±0.118 (17.7±3.0)	0.157 (4.0)	0.055 (1.4)	0.945 (24.0)	0.280 (7.1)
	DB1/3	25	0.394 (10.0)	0.697±0.118 (17.7±3.0)	0.157 (4.0)	0.055 (1.4)	0.945 (24.0)	0.280 (7.1)
	DB6	25	0.394 (10.0)	0.697±0.118 (17.7±3.0)	0.157 (4.0)	0.083 (2.1)	0.945 (24.0)	0.280 (7.1)
	DB2	40	0.394 (10.0)	0.697±0.138 (17.7±3.5)	0.157 (4.0)	0.071 (1.8)	0.945 (24.0)	0.280 (7.1)
	DB7	45	0.394 (10.0)	0.697±0.138 (17.7±3.5)	0.157 (4.0)	0.083 (2.1)	0.945 (24.0)	0.280 (7.1)
	UD DB5	4	1.063 (27.0)	0.913±0.315 (23.2±8.0)	0.394 (10.0)	0.236 (6.0)	1.732 (44.0)	1.622 (41.2)
	DB1/3	9	1.063 (27.0)	0.913±0.315 (23.2±8.0)	0.394 (10.0)	0.236 (6.0)	1.732 (44.0)	1.622 (41.2)
	DB6	9	1.063 (27.0)	0.913±0.315 (23.2±8.0)	0.394 (10.0)	0.354 (9.0)	1.732 (44.0)	1.622 (41.2)
	DB2/7	—	—	—	—	—	—	on request
	TB DB5	14	0.354 (9.0)	0.669±0.098 (17.0±2.5)	0.138 (3.5)	0.047 (1.2)	0.866 (22.0)	0.185 (4.7)
	DB1/3	30	0.354 (9.0)	0.669±0.098 (17.0±2.5)	0.138 (3.5)	0.047 (1.2)	0.866 (22.0)	0.185 (4.7)
	DB6	30	0.354 (9.0)	0.669±0.098 (17.0±2.5)	0.138 (3.5)	0.071 (1.8)	0.866 (22.0)	0.185 (4.7)
	DB2	50	0.354 (9.0)	0.669±0.118 (17.0±3.0)	0.138 (3.5)	0.059 (1.5)	0.866 (22.0)	0.185 (4.7)
	DB7	56	0.354 (9.0)	0.669±0.118 (17.0±3.0)	0.138 (3.5)	0.071 (1.8)	0.866 (22.0)	0.185 (4.7)
	TC DB5	12	0.394 (10.0)	0.689±0.118 (17.5±3.0)	0.157 (4.0)	0.055 (1.4)	0.945 (24.0)	0.280 (7.1)
	DB1/3	25	0.394 (10.0)	0.689±0.118 (17.5±3.0)	0.157 (4.0)	0.055 (1.4)	0.945 (24.0)	0.280 (7.1)
	DB6	25	0.394 (10.0)	0.689±0.118 (17.5±3.0)	0.157 (4.0)	0.083 (2.1)	0.945 (24.0)	0.280 (7.1)
	DB2	40	0.394 (10.0)	0.689±0.138 (17.5±3.5)	0.157 (4.0)	0.071 (1.8)	0.945 (24.0)	0.280 (7.1)
	DB7	45	0.394 (10.0)	0.689±0.138 (17.5±3.5)	0.157 (4.0)	0.083 (2.1)	0.945 (24.0)	0.280 (7.1)
	TD DB5	4	1.063 (27.0)	0.906±0.315 (23.0±8.0)	0.394 (10.0)	0.236 (6.0)	1.732 (44.0)	1.622 (41.2)
	DB1/3	9	1.063 (27.0)	0.906±0.315 (23.0±8.0)	0.394 (10.0)	0.236 (6.0)	1.732 (44.0)	1.622 (41.2)
	DB6	9	1.063 (27.0)	0.906±0.315 (23.0±8.0)	0.394 (10.0)	0.354 (9.0)	1.732 (44.0)	1.622 (41.2)
	DB2/7	—	—	—	—	—	—	on request
	GB* DB5	10	0.394 (10.0)	0.508±0.102 (12.9±2.6)	0.118 (3.0)	0.055 (1.4)	0.787 (20.0)	0.370 (9.4)
	DB1/3	21	0.394 (10.0)	0.508±0.102 (12.9±2.6)	0.118 (3.0)	0.055 (1.4)	0.787 (20.0)	0.370 (9.4)
	DB6	21	0.394 (10.0)	0.508±0.102 (12.9±2.6)	0.118 (3.0)	0.083 (2.1)	0.787 (20.0)	0.370 (9.4)
	DB2	36	0.394 (10.0)	0.508±0.102 (12.9±2.6)	0.118 (3.0)	0.055 (1.4)	0.787 (20.0)	0.370 (9.4)
	DB7	42	0.394 (10.0)	0.508±0.102 (12.9±2.6)	0.118 (3.0)	0.083 (2.1)	0.787 (20.0)	0.370 (9.4)
	GC* DB5	7	0.512 (13.0)	0.571±0.142 (14.5±3.6)	0.157 (4.0)	0.071 (1.8)	0.945 (24.0)	0.638 (16.2)
	DB1/3	16	0.512 (13.0)	0.571±0.142 (14.5±3.6)	0.157 (4.0)	0.071 (1.8)	0.945 (24.0)	0.638 (16.2)
	DB6	16	0.512 (13.0)	0.571±0.142 (14.5±3.6)	0.157 (4.0)	0.083 (2.1)	0.945 (24.0)	0.638 (16.2)
	DB2	26	0.512 (13.0)	0.571±0.142 (14.5±3.6)	0.157 (4.0)	0.071 (1.8)	0.945 (24.0)	0.638 (16.2)
	DB7	30	0.512 (13.0)	0.571±0.142 (14.5±3.6)	0.157 (4.0)	0.094 (2.4)	0.945 (24.0)	0.638 (16.2)
	HB* DB5	11	0.354 (9.0)	0.531±0.098 (13.5±2.5)	0.098 (2.5)	0.055 (1.4)	0.787 (20.0)	0.311 (7.9)
	DB1/3	23	0.354 (9.0)	0.531±0.098 (13.5±2.5)	0.098 (2.5)	0.055 (1.4)	0.787 (20.0)	0.311 (7.9)
	DB6	23	0.354 (9.0)	0.531±0.098 (13.5±2.5)	0.098 (2.5)	0.083 (2.1)	0.787 (20.0)	0.311 (7.9)
	DB2	29	0.354 (9.0)	0.531±0.098 (13.5±2.5)	0.098 (2.5)	0.055 (1.4)	0.787 (20.0)	0.311 (7.9)
	DB7	45	0.354 (9.0)	0.531±0.098 (13.5±2.5)	0.098 (2.5)	0.083 (2.1)	0.787 (20.0)	0.311 (7.9)
	OB* DB5	11	0.354 (9.0)	0.693±0.098 (17.6±2.5)	0.079 (2.0)	0.055 (1.4)	0.906 (23.0)	0.287 (7.3)
	DB1/3	23	0.354 (9.0)	0.693±0.098 (17.6±2.5)	0.079 (2.0)	0.055 (1.4)	0.906 (23.0)	0.287 (7.3)
	DB6	23	0.354 (9.0)	0.693±0.098 (17.6±2.5)	0.079 (2.0)	0.083 (2.1)	0.906 (23.0)	0.287 (7.3)
	DB2	39	0.354 (9.0)	0.693±0.098 (17.6±2.5)	0.079 (2.0)	0.055 (1.4)	0.906 (23.0)	0.287 (7.3)
	DB7	45	0.354 (9.0)	0.693±0.098 (17.6±2.5)	0.079 (2.0)	0.083 (2.1)	0.906 (23.0)	0.287 (7.3)

*For 85°C only

Ordering Information

DB 1		
Series/Prefix		
Code	UL Rating 1054	EN 61058 Rating
1	5A, 125/250VAC	6A, 250V~
2	10.1A, 125/250VAC 1/4HP, 125VAC	10(1.5)A, 250V~
3	0.1A, 125/250VAC	0.1A, 250V
5*	1A, 125/250VAC	1A, 250V
6*	5A, 125/250VAC	6A, 250V
7*	10.1A, 125/250VAC 1/4 HP, 125VAC	10 (1.5)A, 250V~

*85°C only

Specifications subject to change without notice.

B	
Code	Contact Configuration
+120°C Operating Temp	
A	SPST NO
B	SPST NC
C	SPDT
+85°C Operating Temp*	
E	SPST NO
F	SPST NC
G	SPDT

*85°C versions use plastic levers

B1	
Code	Terminal Type inches (mm)
B1	0.110 x 0.020 (2.8 x 0.5) QC, Straight
A1	Solder, Short
C1	0.051 x 0.020 (1.3 x 0.5) PCB, Straight
D1	0.024 x 0.020 (0.6 x 0.5) PCB, Straight
D2	0.024 x 0.020 (0.6 x 0.5) PCB, RH Side with Location Pins
D3	0.024 x 0.020 (0.6 x 0.5) PCB, LH Side with Location Pins
D4	0.024 x 0.020 (0.6 x 0.5) PCB, RH Side
D5	0.024 x 0.020 (0.6 x 0.5) PCB, LH Side

AA	
Code	Actuator Type*
AA	Spherical-head w/o Auxiliary Actuator
BA	Radius w/o Auxiliary Actuator

*For further actuators see Actuation Specifications table.