

Capacitive Touch Sensing ICs and the Appliance Industry

WHITE PAPER

OMRON created the B6T series of touch-sensing ICs, to offer an extremely fast methodology for developing an appliance touch panel and firmware, to implement its operation; *this occurs in the briefest period of time*. Thus, OMRON is making use of its expertise & know-how, in the form of software, to allow for quick product development. The B6T series offers a circuit design support tool called the Workbench, which has eliminated the need for *expertise or know-how* in the analog circuitry required for installation in devices **and** allows simple use, by anybody, with a basic knowledge of digital circuitry.

In the appliance industry, the above relates to a quick turn-around, when a new product platform is in-place, with a tight-schedule. Once the touch panel is designed, the development time, regarding the firmware, can be reduced to hours & days, from weeks & months!

The B6T series has integrated detecting and processing functions, into a single-chip IC; this makes it possible to adjust sensitivity, using software. The above achieves a highly-reliable package, including noise processing, and operating environment compensation while maintaining excellent flexibility.

Overview

In the case of the 4-channel device, the chip is a sensing IC to detect micro capacitances and can be used in appliance touch sensing panels. Internally, the chip employs the 16 bit CMOS process and is contained in a 20-pin SSOP plastic package. The IC has 4 independent measurement pins, each of which can measure capacitance independently. On/off output or serial communication output can be selected as the output form. The IC is provided with an EEPROM that can store the end-customer's parameter set; *this would include momentary vs. toggle, threshold levels, single vs. serial output mode, to name a few*.

The IC is available in 4 and 8 channel, with the 16 channel available the beginning of 2007. The 8 channel B6TS IC is appropriate for use in laundry controls, refrigeration, range hoods, dish washers, and other designs where the input count is applicable.

To minimize the cost of the finished system, low-cost commercial single-sided PCB materials - such as FR-4, FR-2 or CEM-1 can be used. For non-flat user interfaces, FPCs (Flexible Printed Circuit) can be used to build

unique design touch panel solutions. Touch keys can be produced using any non-conducting panel material including plastic, rubber, glass, marble, and wood.

The B6TS sensor chips allow you to create exciting solutions with various materials, graphics and special lighting effects that will let your product stand out. The above permits an appliance maker to create the same “look”, as the other products built. B6Ts also allow for backlighting and clear sensing solutions with ITO and other clear materials to create backlight touch keys for special effects. Touch switches over LCD and LED backlighting and cost-effective multi-key solutions, which can enhance appliance panel designs.

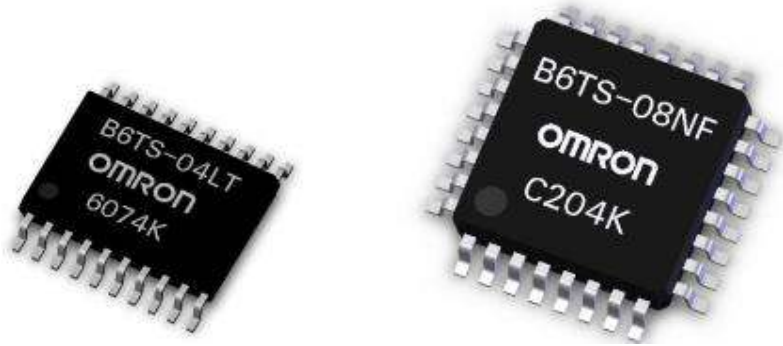

As can be observed, the product line functions, line-up as follows:

- **Runs on Windows PCs (Windows XP and 2000 recommended)**
- **Connects with a PC, via serial communication**
 - **Parameter setting function**
 - **Operation monitor function**
 - **Capacitance calculation function**
- **Comes with an evaluation board for four or eight channels for immediate evaluation:**
- **Four channels: B6TW-S04LT**
- **Eight channels: B6TW-S08NF**
- **Twelve Channels: *Coming in February, 2007***

The basic ground-loop capacitance design is as follows:

Detection Principle

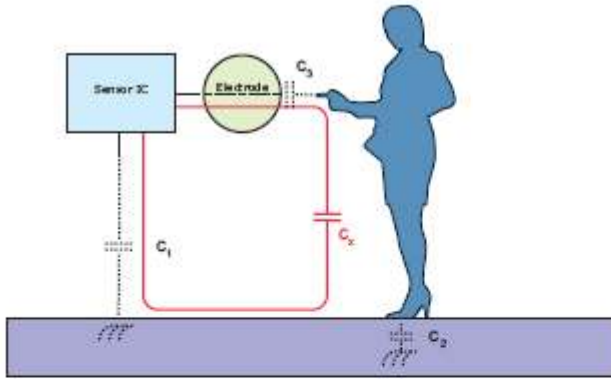

- Detect the capacitance of C_x
- C_x = (combined capacity of C₁, C₂ and C₃)
- C_x is dominated by C₃, since C₃ << C₁ and C₂

Capacitance Sensing Method

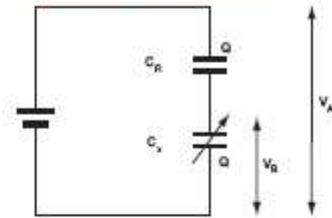

$$V_B = V_A \times \frac{C_R}{C_R + C_X}$$

$$C_X = \frac{C_R \times (V_A - V_B)}{V_B}$$

- Connect fixed capacitor (C_R) and unknown capacitor (C_X) serially
- C_X is known by measuring V_B and V_A

Sampling Data

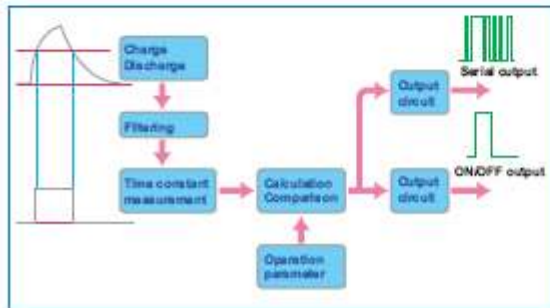

Omron's unique "series capacitance division comparison system" enhances reliability

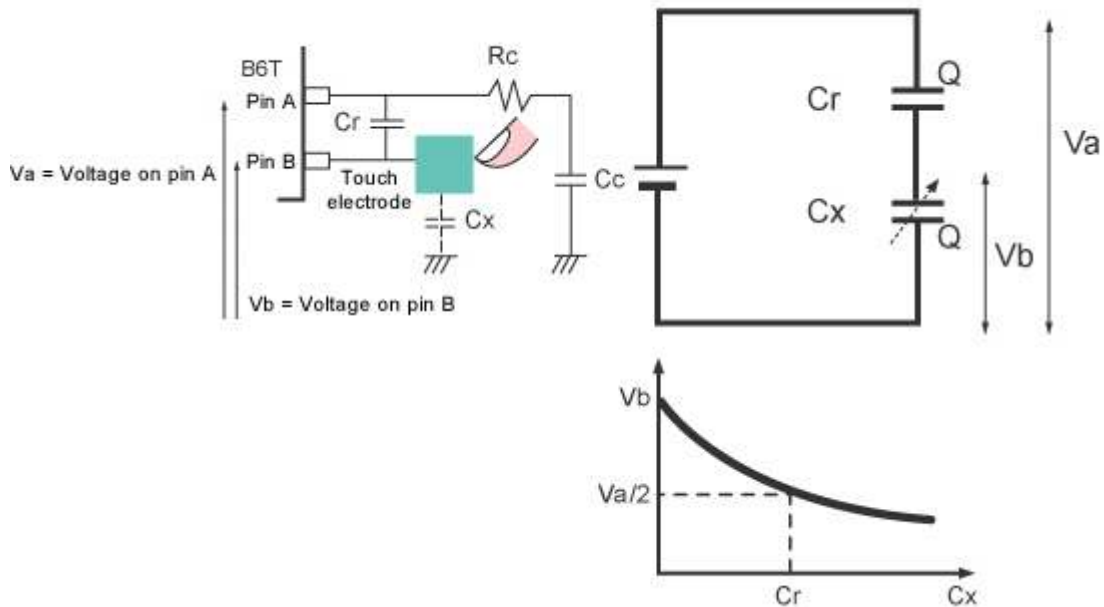

Generally, measurement of capacitance value, C, requires conversion of the value into an electrical signal such as a frequency, voltage, etc. For B6T, the value C_x is converted into voltage. Although various methods are available for converting capacitance into voltage, B6T series uses the “series capacitance division comparison system” (patent pending). When the voltage on pin A of B6T is represented with V_a and the voltage on pin B with V_b , measuring V_b allows detection of change in an unknown capacitance value, C_x .

$$V_b = V_a \times \frac{C_r}{C_r + C_x}$$

$$C_x = \frac{C_r \times (V_a - V_b)}{V_b}$$

Specifically, the voltage ratio of the fixed capacitance value C_r to the varying and unknown capacitance value C_x is measured. Under this method, measuring change in the voltage ratio detects the capacitance change generated by the approach of a person to the electrode, which allows sensing of whether a person has touched the electrode.

As mentioned earlier, development time is pivotal for the B6T, thus, the OMRON Workbench software, *the development flowchart*, is briefly stated below. The 1st step of **appearance design** is simply the design of the touch panel. The circuit design/circuit constants are derived from the OMRON development software. Step 4 is a result of real time usage of the Workbench development kit.

Development / Mass Production Process

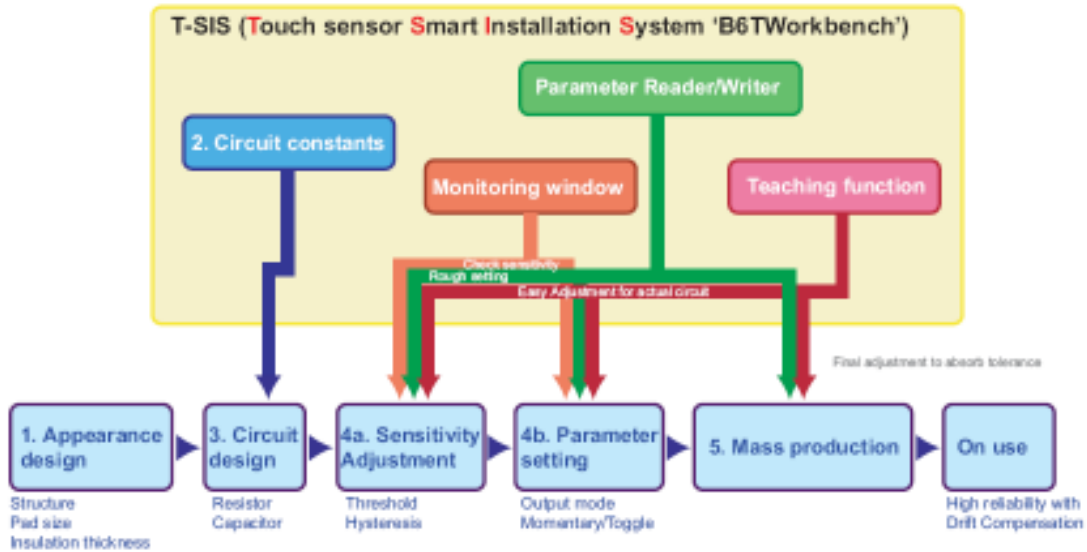

Connection

■ Pin assignment for the 4-channel IC.

(TOP VIEW)

1	OUT2/SCK	B6TS-04LT	OUT1/SCS	20
2	OUT3/SD		OUT0/CHG	19
3	RESET		CH0A	18
4	TEST1		CH0B	17
5	VSS		VDD	16
6	MEAS		CH1A	15
7	VDD		CH1B	14
8	TEST2		CH2A	13
9	SETUP		CH2B	12
10	CH3B		CH3A	11

■ Pin functions

No.	Designation	Pin function
1	OUT2 /SCK	Channel 2 output/serial communication clock
2	OUT3 /SD	Channel 3 output/serial communication data
3	RESET	Reset
4	TEST1	To VDD through pull-up resistor
5	VSS	Ground (0 V)
6	MEAS	Measurement start
7	VDD	Power (3.0-5.5 V)
8	TEST2	To VDD through pull-up resistor
9	SETUP	Operating mode switch
10	CH3B	Channel 3 external circuit connection
11	CH3A	Channel 3 touch electrode connection
12	CH2B	Channel 2 external circuit connection
13	CH2A	Channel 2 touch electrode connection
14	CH1B	Channel 1 external circuit connection
15	CH1A	Channel 1 touch electrode connection
16	VDD	Power (3.0-5.5 V)
17	CH0B	Channel 0 external circuit connection
18	CH0A	Channel 0 touch electrode connection
19	OUT0 /CHG	Channel 0 output/measurement complete
20	OUT1/SCS	Channel 1 output/serial communication chip select

The below shows the pin output for the four-channel version. As can be seen, the IC can be configured for four individual output lines, or one serial line – which is user determined. *The eight & twelve channel also have a similar configuration.*

Sample circuit

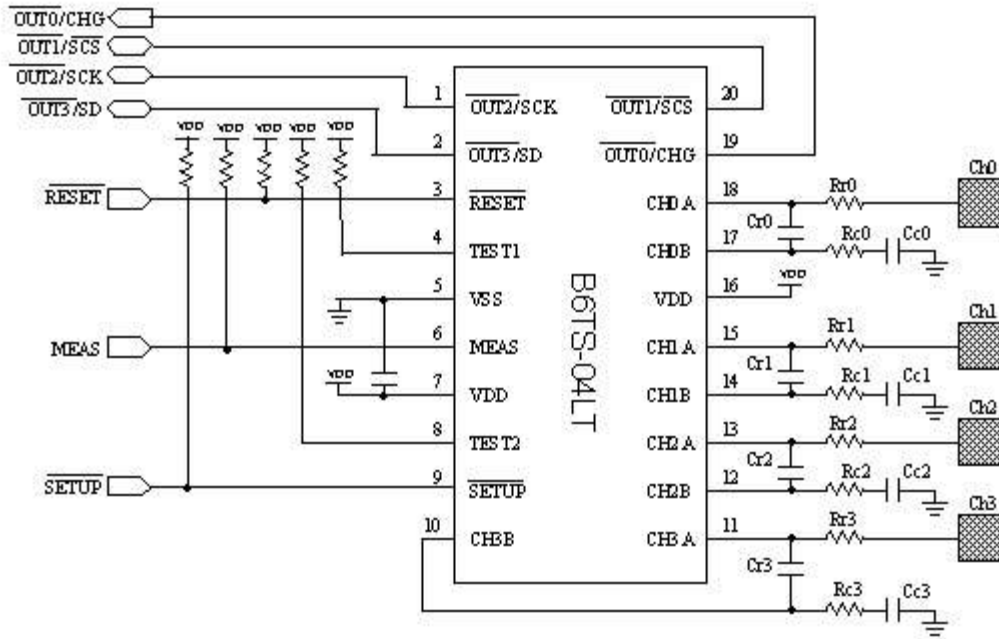

Development

What really sets the B6T sensing IC apart from others is the rapid development through software and know-how, *provided with the OMRON B6TW development kit.*

The emulator board, with its connection to a PC, and test panel, is shown below:

B6TS Touch Sensing IC

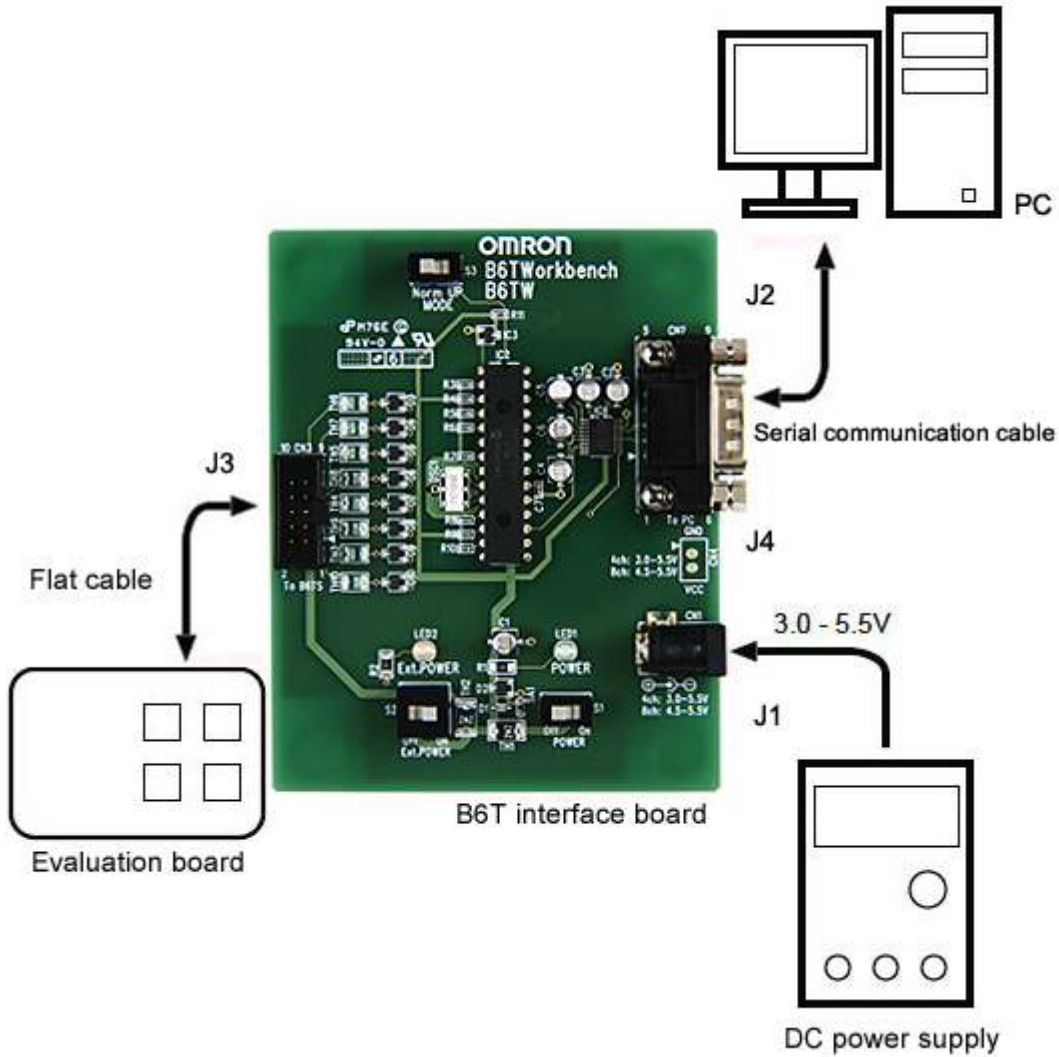

Evaluation board for eight channels (supplied with B6TW-S08NF)



The actual B6T touch sensing IC is located on the evaluation board. Although OMRON supplies an evaluation board, the customer's prototype of the appliance touch panel must be built, and put in its place.

The B6TW development Windows driven program, starts off with the following screen:

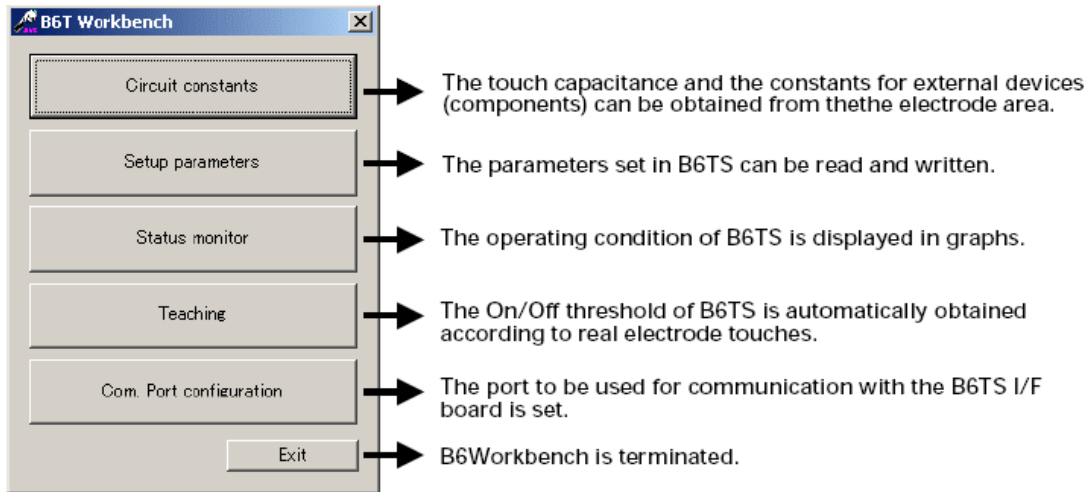

The first screen (below), circuit constraints, lets the user determine the physical constants, of the appliance control design. By entering the pad size, line length, thickness of the panel, and permittivity (material) of the panel, the two fixed capacitors (C_r and C_c) can be established. In addition, the fixed resistance, R_c is calculated.

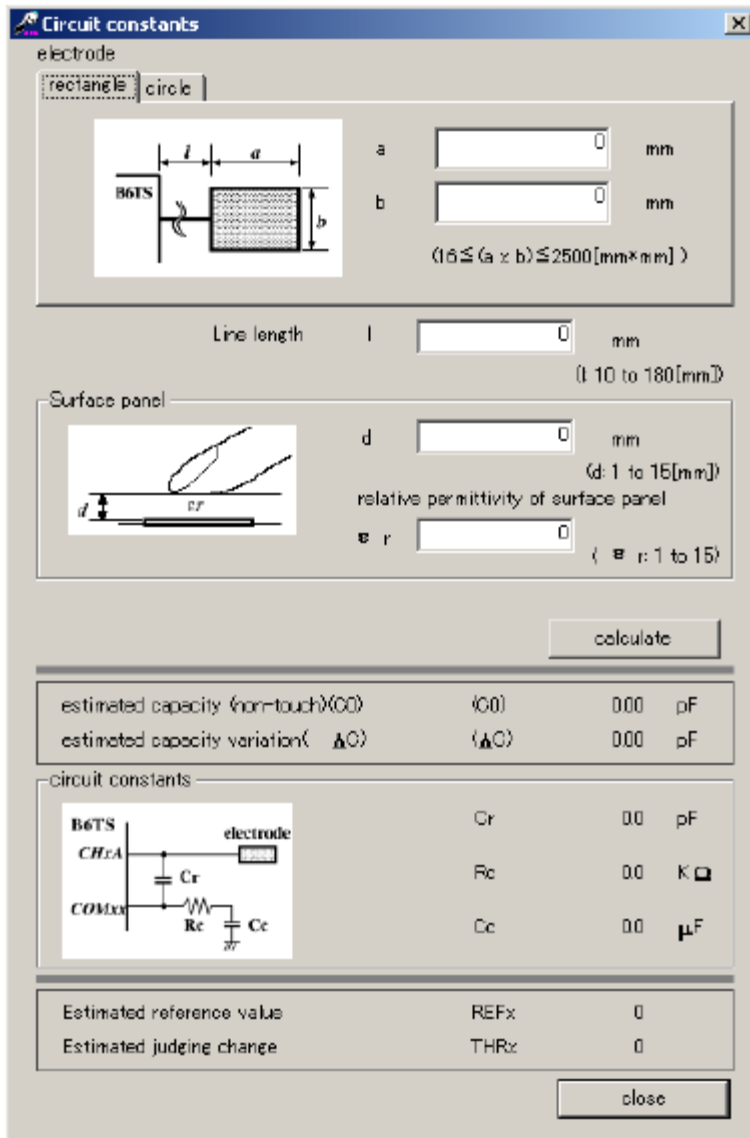

Once the physical constants have been established, and placed on the end-application prototype panel, the Workbench software can be run, to build the product parameter set. As can be seen below, on the eight-channel parameter screen, each channel (switch pad) has its own parameter – including latching/momentary, threshold, timing, and sensitivity.

The OMRON software has the capability of establishing the below parameters, by using the self-teaching function of the Windows based program. Self-teaching is simply a step which asks the user to touch each key, three times. Once the above is completed, the Workbench software, determines the parameter values; this is base-line for beginning to fine-tune the parameter set.

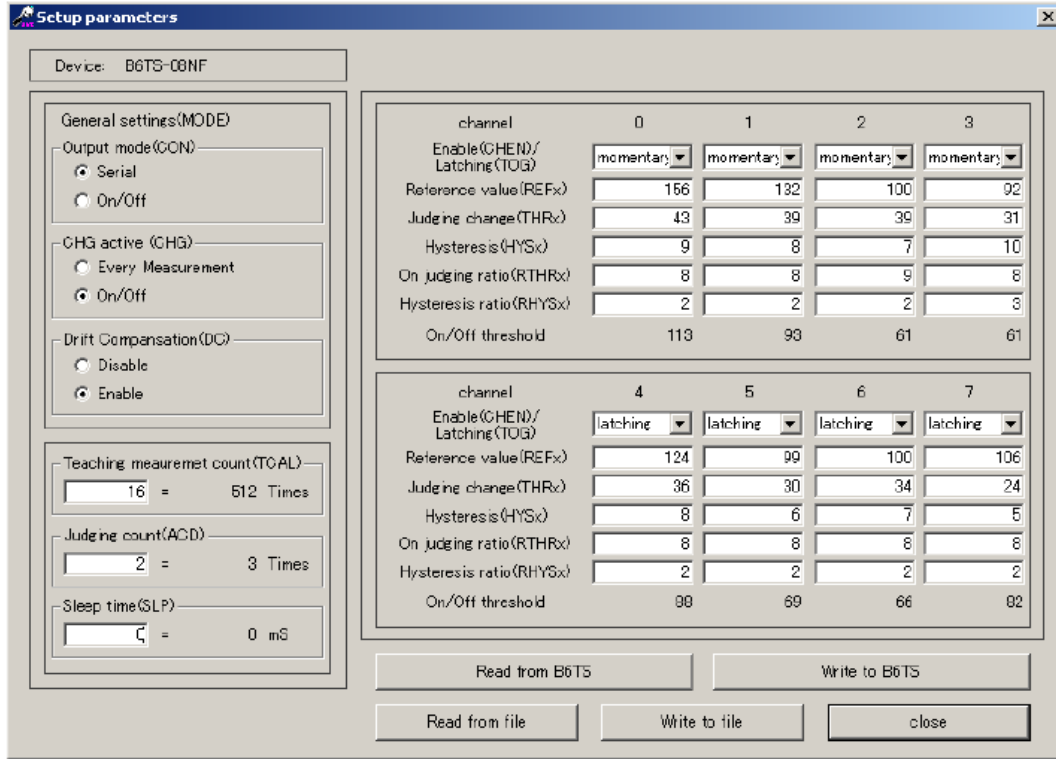

Below, there is a representation of the change in capacitance, when the one's finger, touches the electrode (touch pad). The top represents the reference level, and when one touches the pad, the capacitance changes. The value labeled THR_x is the point at which the threshold is set, to trigger the touch sensing switch point. We recommend that the threshold level capacitance be at least 20% of the reference level.

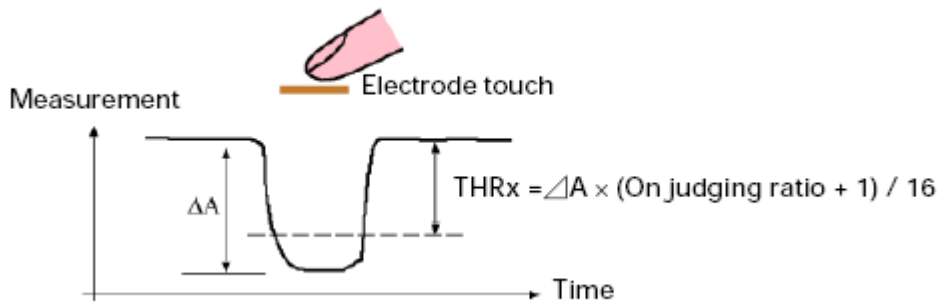

The below is a more detailed description of parameters, in a graphical setting. The red solid line is a representation of what is happening to the capacitance. The **Reference value (REF_x)** is the top dotted blue line, and the **Threshold level (THR_x)** is the green dotted line. The detection integral can be relayed to the delay time, of response. The sampling integral is typically in the hundreds of KHz.

Drift compensation is another key feature of the B6TS IC, in that the design allows for a shift in the reference values, due to environmental conditions; these

may occur in a household condition, in which the appliance is placed. The compensation will automatically adjust the threshold value, to account for the change in the reference, as shown below.

The bottom three graphs represent output lines; the first switch as a **momentary** pad, the second as a **latching** (or toggle) pad. The third line represents the **serial data line** – if that option is chosen.

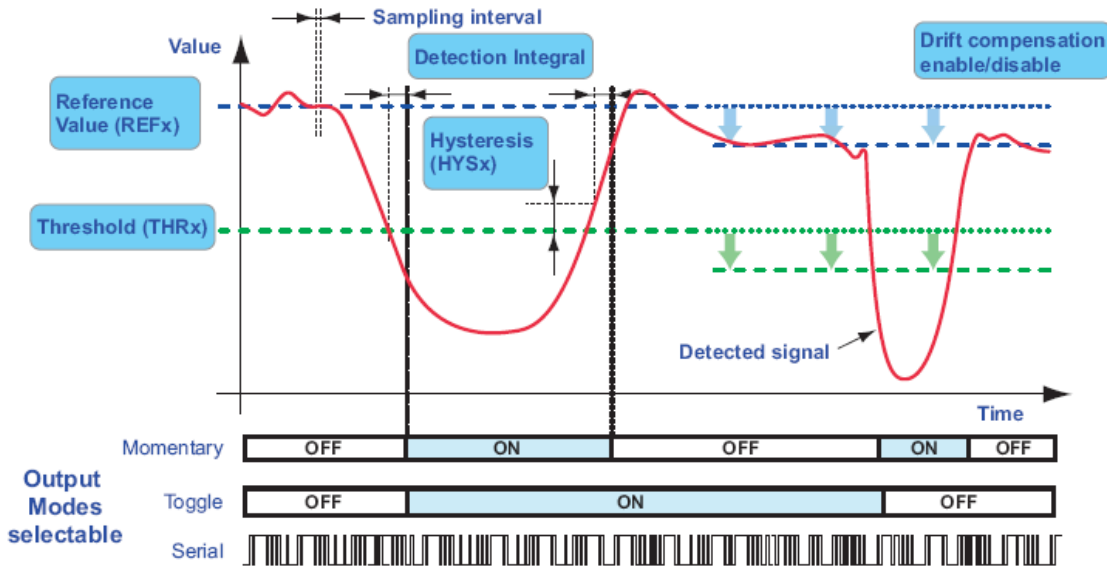

The graph below is what can actually be seen in the development program using the Status Monitor, as shown in the first Workbench menu selection. The Status Monitor allows for the user to see how the touch sensors are performing, in real time. Thus, when developing a control for an appliance, such as a refrigerator, the actual switch sensing can be observed in real-time. Also, several prototypes can be used, in order to test user variations.

The time interval for reading data from B6TS is set (defined).
When the time interval is short, there is no time for calculation and measurement update cannot be performed.
When no measurement update takes place, set a longer time for reading.

Graph display
Red line – Measurement
Blue dotted line – Current reference value (=CREFx)
Green dotted line – Current On/Off threshold (=CREFx - CTHR_x)

The graph is extended, reduced or moved. To center the measurement value in the graph, click the  button.

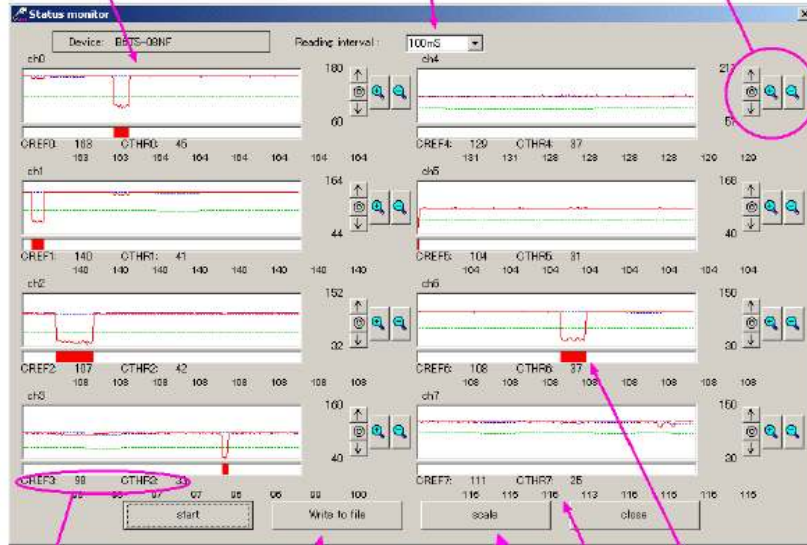

Display data is written to a file. Because this file is created in csv format, data can be read via Excel.

On/Off determination results: When "On" is determined as the result of measurement, a red stripe is displayed.

Current reference value (CREFx)
The current judging change (CTHR_x) is displayed
The value is automatically changed during drift compensation.
For setting without drift compensation, these values are identical to the REF_x and THR_x values of the setup parameter.

Results of the most recent 8 measurements (numeric display)

Scale of Graph display
The Upper/Lower limit of display scale for each channel is defined.

In conclusion, the B6T touch-sensing IC:

1. Improves design efficiency

Semi-automatic sensitivity adjustment, through teaching, expedites development work. Use of the dedicated development tool (B6TWorkbench) allows switch monitoring, on a PC.

2. Creates a sense of high quality

Nonconductive materials including glass and plastic can be used for the touch part, improving freedom of a choice in materials and design in the appliance application.

Just a light touch turns the switch ON or OFF.

3. Provides high reliability

Automatic threshold compensation maintains stable detection performance, in the appliance, regardless of humidity and temperature variation.

A unique algorithm prevents faulty operation due to noise such as radio waves – *in household use*.

4. Enhances application capabilities

The four, eight, or twelve channel sensor lines can be run simultaneously.

More than one sensor can be connected serially, where more switch inputs are required, such as a microwave oven.



To learn more about Omron Electronic Components LLC or the B6TS Touch Sensing IC, visit: www.components.omron.com