

Technical Data Sheet

5mm Infrared LED , T-1 3/4

IR383

Features

- High reliability
- High radiant intensity
- Peak wavelength $\lambda_p=940\text{nm}$
- 2.54mm Lead spacing
- Low forward voltage
- Pb free
- The product itself will remain within RoHS compliant version.

Descriptions

- EVERLIGHT'S Infrared Emitting Diode(IR383) is a high intensity diode , molded in a blue transparent plastic package.
- The device is spectrally matched with phototransistor , photodiode and infrared receiver module.



Applications

- Free air transmission system
- Infrared remote control units with high power requirement
- Smoke detector
- Infrared applied system

Device Selection Guide

LED Part No.	Chip	Lens Color
	Material	
IR	GaAlAs	Blue

Package Dimensions

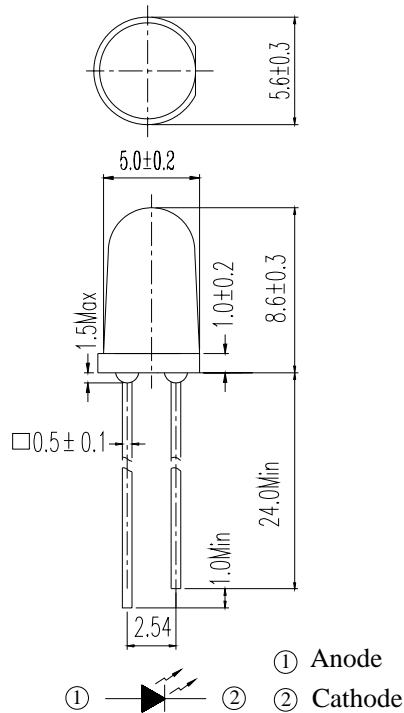

- Notes:** 1.All dimensions are in millimeters
2.Tolerances unless dimensions ± 0.25 mm

Absolute Maximum Ratings (Ta=25°C)

Parameter	Symbol	Rating	Units
Continuous Forward Current	I_F	100	mA
Peak Forward Current *1	I_{FP}	1.0	A
Reverse Voltage	V_R	5	V
Operating Temperature	T_{opr}	-40 ~ +85	°C
Storage Temperature	T_{stg}	-40 ~ +85	°C
Soldering Temperature*2	T_{sol}	260	°C
Power Dissipation at(or below) 25°C Free Air Temperature	P_d	150	mW

- Notes:** *1: I_{FP} Conditions--Pulse Width $\leq 100 \mu s$ and Duty $\leq 1\%$.
*2:Soldering time ≤ 5 seconds.

Electro-Optical Characteristics (Ta=25°C)

Parameter	Symbol	Condition	Min.	Typ.	Max.	Units
Radiant Intensity	Ee	I _F =20mA	7.8	20	--	mW/sr
		I _F =100mA Pulse Width ≤ 100 μs ,Duty ≤ 1%	--	80	--	
		I _F =1A Pulse Width ≤ 100 μs ,Duty ≤ 1%.	--	800	--	
Peak Wavelength	λ p	I _F =20mA	--	940	--	nm
Spectral Bandwidth	Δ λ	I _F =20mA	--	45	--	nm
Forward Voltage	V _F	I _F =20mA		1.2	1.5	V
		I _F =100mA Pulse Width ≤ 100 μs ,Duty ≤ 1%	--	1.4	1.8	
		I _F =1A Pulse Width ≤ 100 μs ,Duty ≤ 1%.	--	2.6	4.0	
Reverse Current	I _R	V _R =5V	--	--	10	μ A
View Angle	2 θ 1/2	I _F =20mA	--	20	--	deg

Rank

 Condition : I_F=20mA

Unit : mW/sr

Bin Number	M	N	P	Q
Min	7.80	11.0	15.0	21.0
Max	12.5	17.6	24.0	34.0

Typical Electro-Optical Characteristics Curves

Fig.1 Forward Current vs. Ambient Temperature

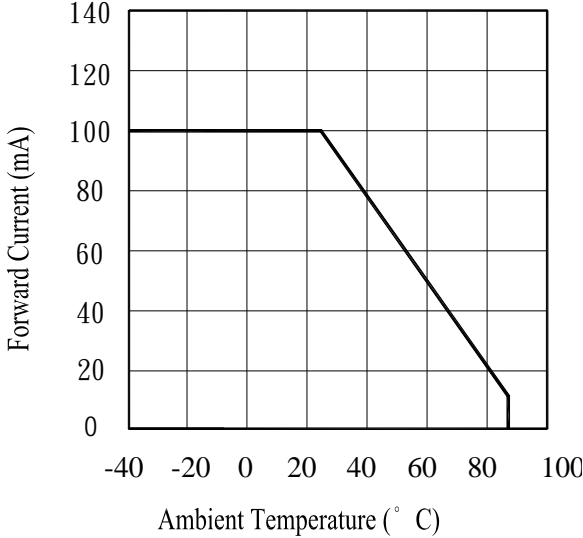

Fig.2 Spectral Distribution

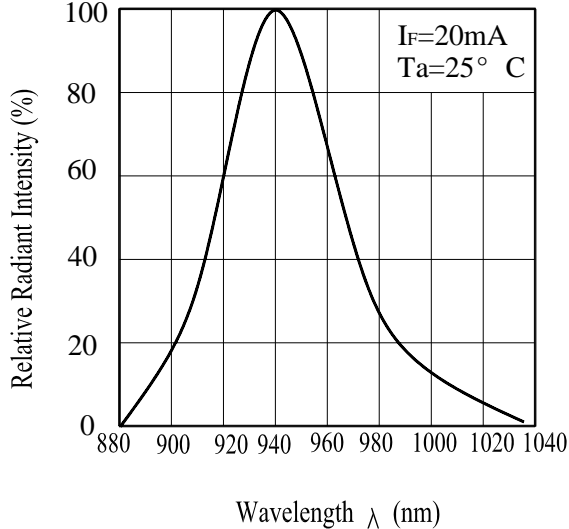

Fig.3 Peak Emission Wavelength vs. Ambient Temperature

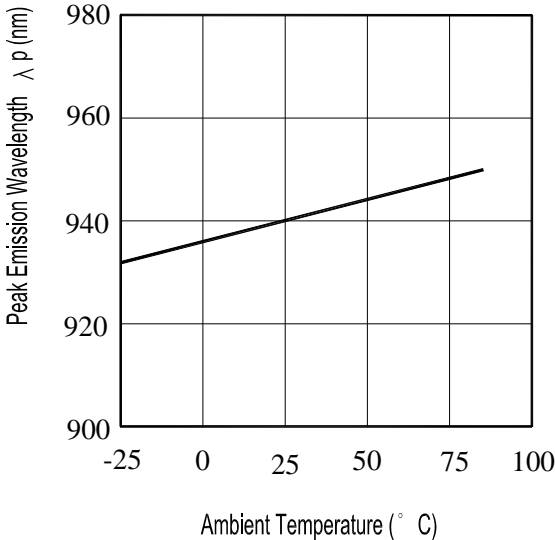
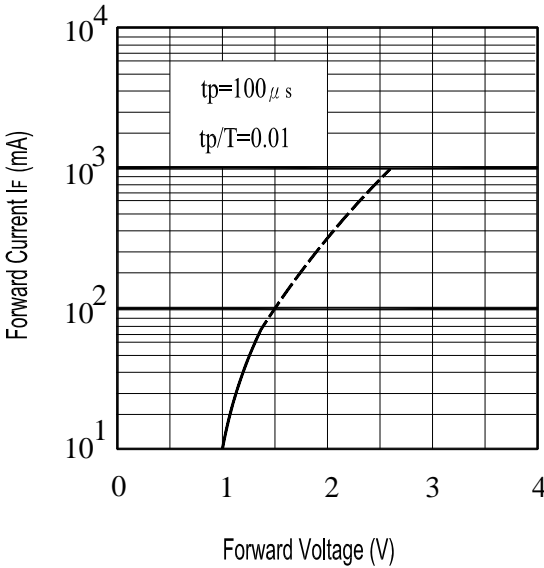

Fig.4 Forward Current vs. Forward Voltage



Downloaded from [Elcodis.com](http://www.Elcodis.com) electronic components distributor

Typical Electro-Optical Characteristics Curves

Fig.5 Radiant Intensity vs. Forward Current

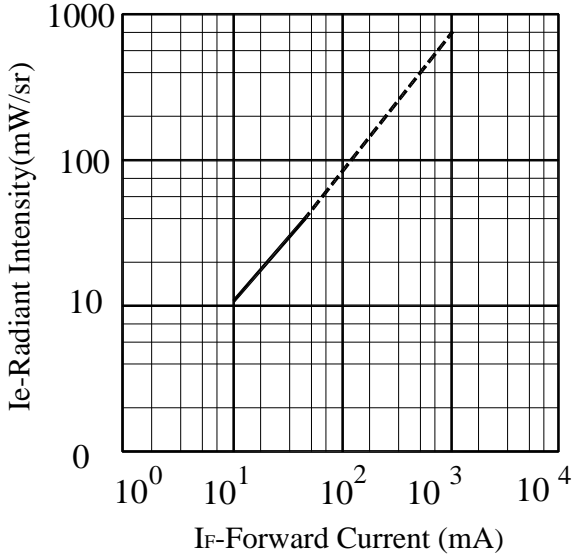

Fig.6 Relative Radiant Intensity vs. Angular Displacement

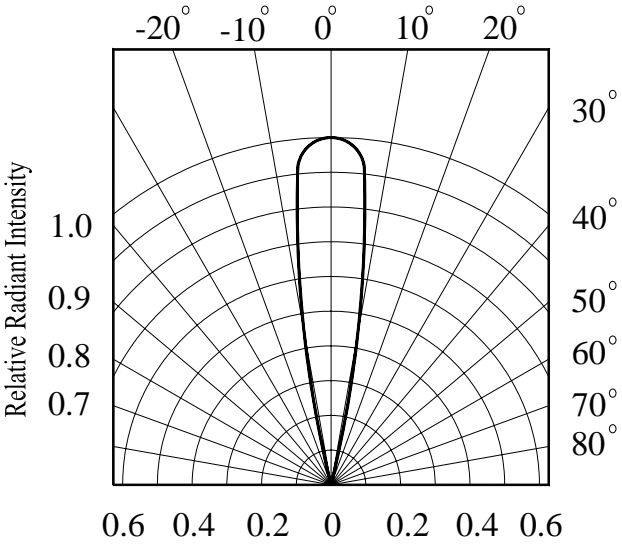

Fig.7 Radiant Intensity vs. Ambient Temperature(°C)

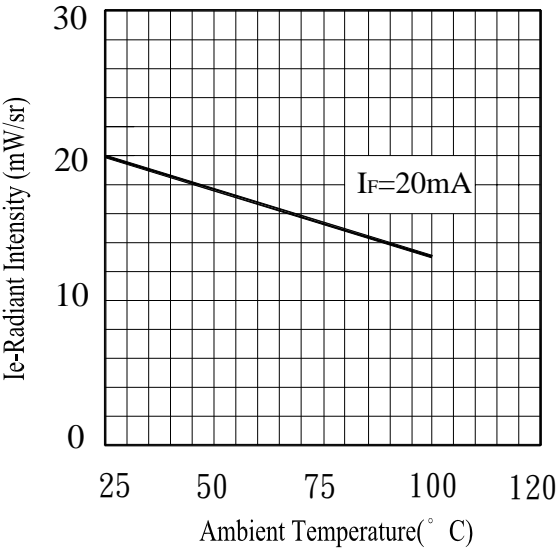
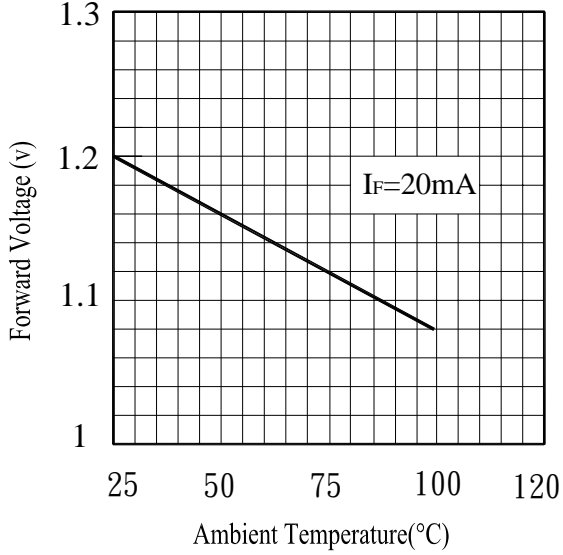

Fig.8 Forward Voltage vs. Ambient Temperature(°C)



Downloaded from [Elcodis.com](http://www.Elcodis.com) electronic components distributor

Reliability Test Item And Condition

The reliability of products shall be satisfied with items listed below.

Confidence level : 90%

LTPD : 10%

NO.	Item	Test Conditions	Test Hours/ Cycles	Sample Sizes	Failure Judgement Criteria	Ac/Re
1	Solder Heat	TEMP. : 260°C±5°C	10secs	22pcs	$I_R \geq U \times 2$ $E_e \leq L \times 0.8$ $V_F \geq U \times 1.2$ U : Upper Specification Limit L : Lower Specification Limit	0/1
2	Temperature Cycle	H : +100°C 15mins ↑ 5mins ↓ L : -40°C 15mins	300Cycles	22pcs		0/1
3	Thermal Shock	H : +100°C 5mins ↑ 10secs ↓ L : -10°C 5mins	300Cycles	22pcs		0/1
4	High Temperature Storage	TEMP. : +100°C	1000hrs	22pcs		0/1
5	Low Temperature Storage	TEMP. : -40°C	1000hrs	22pcs		0/1
6	DC Operating Life	$I_F = 20\text{mA}$	1000hrs	22pcs		0/1
7	High Temperature/ High Humidity	85°C / 85% R.H	1000hrs	22pcs		0/1

Packing Quantity Specification

- 1.500PCS/1Bag , 5Bags/1Box
- 2.10Boxes/1Carton

Label Form Specification



- CPN: Customer's Production Number
- P/N : Production Number
- QTY: Packing Quantity
- CAT: Ranks
- HUE: Peak Wavelength
- REF: Reference
- LOT No: Lot Number
- MADE IN TAIWAN: Production Place

Notes

1. Above specification may be changed without notice. EVERLIGHT will reserve authority on material change for above specification.
2. When using this product, please observe the absolute maximum ratings and the instructions for using outlined in these specification sheets. EVERLIGHT assumes no responsibility for any damage resulting from use of the product which does not comply with the absolute maximum ratings and the instructions included in these specification sheets.
3. These specification sheets include materials protected under copyright of EVERLIGHT corporation. Please don't reproduce or cause anyone to reproduce them without EVERLIGHT's consent.

EVERLIGHT ELECTRONICS CO., LTD.
 Office: No 25, Lane 76, Sec 3, Chung Yang Rd,
 Tucheng, Taipei 236, Taiwan, R.O.C

Tel: 886-2-2267-2000, 2267-9936
 Fax: 886-2267-6244, 2267-6189, 2267-6306
<http://www.everlight.com>