

PRODUCT NO.	SEE DIAGRAM SH. 2
SHEET INDEX	
SHEET 1	TITLE SHEET
SHEET 2	PART NUMBER AND MATED HEIGHT INFO.
SHEET 3	VERTICAL RECEPTACLE WITH HOOK
SHEET 4	VERTICAL RECEPTACLE WITHOUT HOOK
SHEET 5	RIGHT ANGLE RECEPTACLE
SHEET 6	RIGHT ANGLE HEADER
SHEET 7	VERTICAL HEADER WITH HOOK
SHEET 8	VERTICAL HEADER WITHOUT HOOK

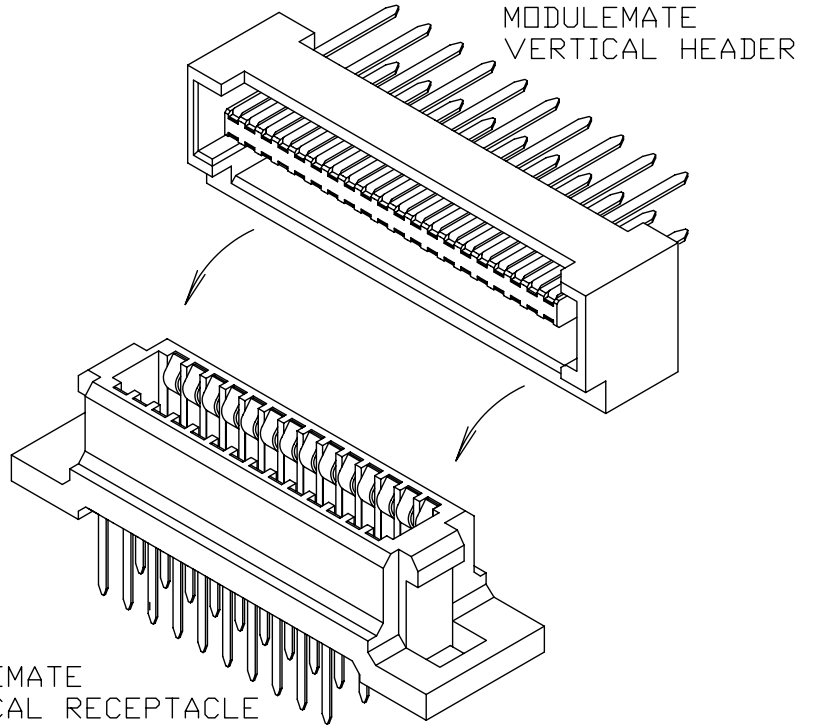

**FEATURES:**

- PITCH = 1.27mm/.05 AT CONTACT INTERFACE
- POSTURE: RIGHT ANGLE RECEPTACLE  
RIGHT ANGLE HEADER  
VERTICAL RECEPTACLE  
VERTICAL HEADER
- NUMBER OF POSITIONS:  
20,30,40,50,60,80,100,120
- MATED HEIGHTS, VERTICAL POSTURE:  
7,8,9,10,12,MM
- PCB RETENTION HOOK ON ALL RIGHT ANGLE ASSEMBLIES, OPTIONAL ON VERTICAL ASSEMBLIES
- RECEPTACLE TERMINAL MATERIAL:  
PHOS-BRONZE WITH 15u"/0.38u MIN GXT IN CONTACT AREA AND 100u"/2.54u MIN SnPb IN SOLDER TAIL AREA  
HEADER TERMINAL MATERIAL:  
PHOS-BRONZE WITH 15u"/0.38u MIN GXT IN CONTACT AREA AND 100u"/2.54u MIN SnPb IN SOLDER TAIL AREA  
HOUSING MATERIAL: LCP, COLOR IS BLACK
- P/N'S WITH SUFFIX "LF" ARE LEAD FREE P/N'S. FOR LEAD FREE P/N'S, ALL SnPb PLATING WILL BE SUBSTITUTED BY PURE TIN
- PACKING STANDARD GS-14-920 WILL BE APPLIED FOR LEAD FREE P/N'S
- FOR LEAD FREE P/N, THE PRODUCT MEET EUROPEAN UNION DIRECTIVES AND OTHER COUNTRY REGULATION AS DESCRIBED IN GS-22-008
- FOR LEAD FREE P/N, THE HOUSING WILL WITHSTAND EXPOSURE TO 260°C PEAK TEMPERATURE FOR 40 SECONDS IN A CONVECTION, INFRO-RED OR VAPOR PHASE REFLOW OVEN.

MODULEMATE VERTICAL RECEPTACLE

mat'l. code				tolerances unless otherwise specified		CUSTOMER COPY		FCI www.fciconnect.com	
ltr	ecr no	dr	date	linear	.X ± 0.3	projection	title MODULEMATE CONNECTOR ASSEMBLY		
H	V11178	TAI	05/09/01		.XX ± 0.13	MM	product family MODULEMATE code		
J	N05-0269	PH	09/28/05		.XXX ± 0.05		size		
K	N06-0304	LONG	12/04/06	angles	0° ± 2°	scale	A3	95747	sheet 1 of 8
E	T60403	L S	10/5/96	dr	KENNY TAI	05/09/01	dwg no		
F	T70121	L S	03/27/97	enr	KENNY TAI	05/09/01	sheet		
G	T80299	CH	07/13/98	chr	KENNY TAI	05/09/01	1 of 8		
sheet index	revision sheet	K	J	K	J	K	J	J	
		1	2	3	4	5	6	7	8

**PDM! Rev:K** STATUS:Released Printed: Nov 09, 2010 6

MODULEMATE ASSEMBLY PRODUCT  
NUMBERS, HEADERS AND RECEPTACLES  
PRODUCT NUMBER 9 5 7 G P - N N H

GENDER	CODE
HEADER	4
RECEPTACLE	5

POSTURE	CODE
RIGHT ANGLE	7
VERTICAL W/HOOK	8
VERTICAL W/O HOOK	9

CODE	MATING DISTANCE	
	HEADER	RECEPTACLE
	SEE TABLES 1 FOR VERTICAL MATING; TABLE 2 FOR HORIZONTAL MATING, AND TABLES 3 AND 4 FOR RIGHT ANGLE MATING	

CODE	TOTAL NUMBER OF POSITIONS
02	20
03	30
04	40
05	50
06	60
08	80
10	100
12	120

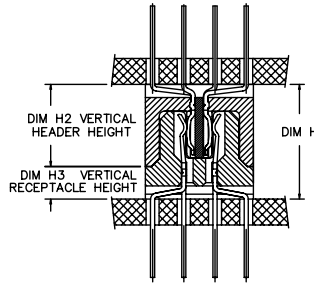

HEADER CODE	RECEPTACLE CODE	MATED HEIGHT	DIM H2	DIM H3
5	2	7	5	2
5	3	8	5	3
7	2	9	7	2
7	3	10	7	3
5	5	10	5	5
7	5	12	7	5

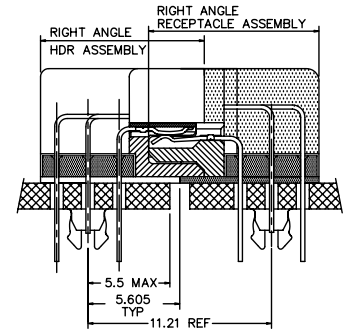

HEADER CODE	RECEPTACLE CODE	
8	8	RIGHT ANGLE HEADER TO RIGHT ANGLE RECEPTACLE

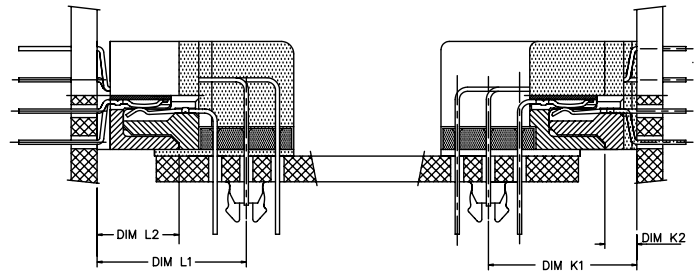

HEADER CODE	RECEPTACLE CODE		L1	L2
5	8	VERTICAL HEADER TO RIGHT ANGLE RECEPT.	9.105	5
7	8		11.105	7

HEADER CODE	RECEPTACLE CODE		K1	K2
8	2	RIGHT ANGLE HEADER TO VERTICAL RECEPTACLE	9.06	2
8	3		10.06	3
8	5		12.06	5

mat'l. code				tolerances unless otherwise specified		CUSTOMER COPY		FCI		
ltr	ecn	no	dr	date	linear	.X ± 0.3	projection	title		
						.XX ± 0.13		MODULEMATE CONNECTOR ASSEMBLY		
					angles	.XXX ± 0.05		product family MODULEMATE code		
						0° ± 2°	MM	size		
			dr	KENNY TAI	05/09/01		scale	A3	95747	sheet 2 of
			enr	KENNY TAI	05/09/01					
			chr	KENNY TAI	05/09/01					
			appd	PAUL WANG	05/09/01					
sheet index	revision	sheet								

PRODUCT NUMBER	POS.	DIM A	DIM B	DIM E	DIM P	TYPE	COMMENTS
95758-022/022LF	20	25.43	20.32	11.43	5.4	STYLE I	AVAILABLE
-032	30	31.78	26.67	17.78			
-042	40	38.13	33.02	24.13			
-052	50	44.48	39.37	30.48			
-062/062LF	60	50.83	45.72	36.83			
-082	80	63.53	58.42	49.53			NOT TOOLED
-102	100	76.23	71.12	62.23			
95758-122	120	88.93	83.82	74.93	5.4	STYLE I	
95758-023	20	25.43	20.32	13.43	6.4	STYLE I	
-033	30	31.78	26.67	19.78			
-043	40	38.13	33.02	26.13			NOT TOOLED
-053	50	44.48	39.37	32.48			
-063	60	50.83	45.72	38.83			
-083	80	63.53	58.42	51.53			
-103	100	76.23	71.12	64.23			
95758-123	120	88.93	83.82	76.93	6.4	STYLE I	NOT TOOLED
95758-025	20	25.43	20.32	13.43	8.4	STYLE II	
-035	30	31.78	26.67	19.78			
-045	40	38.13	33.02	26.13			
-055	50	44.48	39.37	32.48			
-065	60	50.83	45.72	38.83			NOT TOOLED
-085	80	63.53	58.42	51.53			
-105	100	76.23	71.12	64.23			
95758-125	120	88.93	83.82	76.93	8.4	STYLE II	

VERTICLE RECEPTACLE WITH HOOKS SHOWN ON THIS SHEET

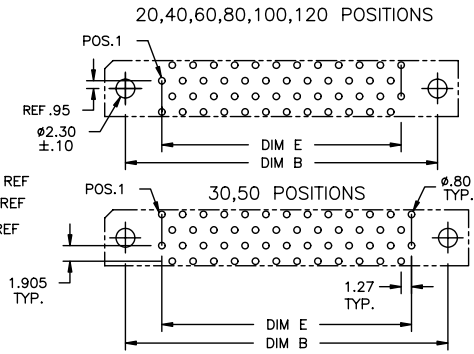
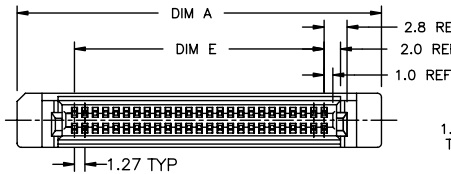

RECOMMENDED PCB LAYOUT

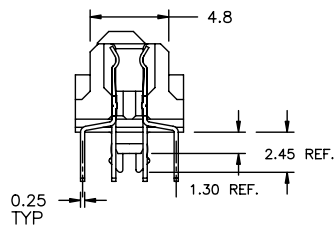
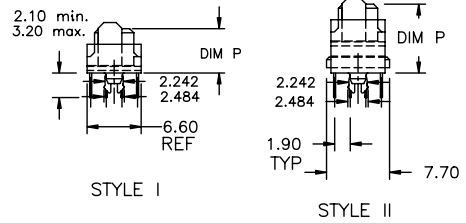
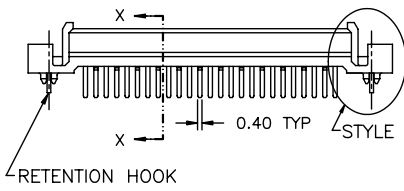

SECTION X-X  
STYLE I

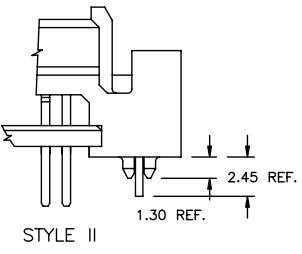

STYLE II

mat'l. code		tolerances unless otherwise specified		CUSTOMER COPY		FCJ www.fcjconnect.com	
ltr	ecm no	dr	date	linear	.X ± 0.3	projection	title
K					.XXX ± 0.13	MM	MODULEMATE CONNECTOR ASSEMBLY
				angles	.XXX ± 0.05	MM	product family MODULEMATE code
				dr	0° ± 2°	MM	size
				enr		MM	dwg no
				chr		MM	95747
				appd		MM	sheet
sheet	revision						3 of
index	sheet						

All rights reserved. No part of this document may be reproduced, stored in a retrieval system, or transmitted, in any form or by any means, electronic, mechanical, photocopying, recording, or by any information storage and retrieval system, without the prior written permission of FCJ.

All data subject to change. Availability of items is not guaranteed. For more information, please contact your local sales office. © 2010 FCI. All rights reserved.

PRODUCT NUMBER	POS.	DIM A	DIM E	DIM P	TYPE	COMMENTS	
95759-022	20	18.83	11.43	5.4	STYLE I	AVAILABLE	
-032	30	25.18	17.78	NOT TOOLED			
-042	40	31.53	24.13				
-052	50	37.88	30.48				
-062	60	44.23	36.83	AVAILABLE			
-082	80	56.93	49.53				
-102	100	69.63	62.23				
95759-122	120	82.33	74.93	5.4	STYLE I		
95759-023	20	18.83	13.43	6.4		STYLE I	NOT TOOLED
-033	30	25.18	19.78				
-043	40	31.53	26.13				
-053	50	37.88	32.48				
-063	60	44.23	38.83				
-083	80	56.93	51.53				
-103	100	69.63	64.23				
95759-123	120	82.33	76.93	6.4	STYLE II		
95759-025	20	18.83	13.43	8.4		STYLE II	
-035	30	25.18	19.78				
-045	40	31.53	26.13				
-055	50	37.88	32.48				
-065	60	44.23	38.83				
-085	80	56.93	51.53				
-105	100	69.63	64.23				
95759-125	120	82.33	76.93	8.4			

VERTICLE RECEPTACLE WITHOUT HOOK SHOWN ON THIS SHEET

RECOMMENDED PCB LAYOUT

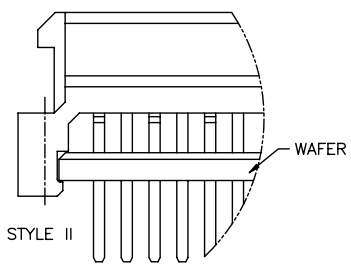
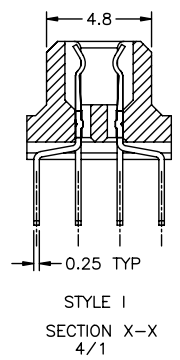
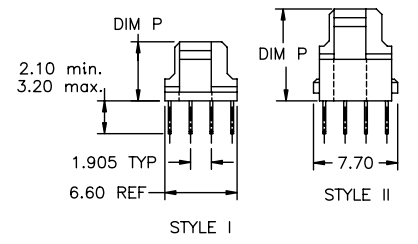
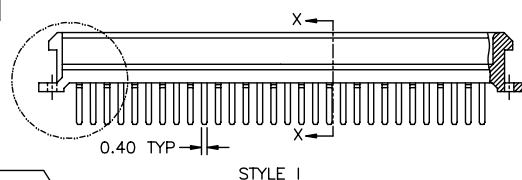
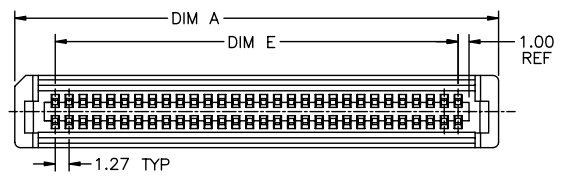
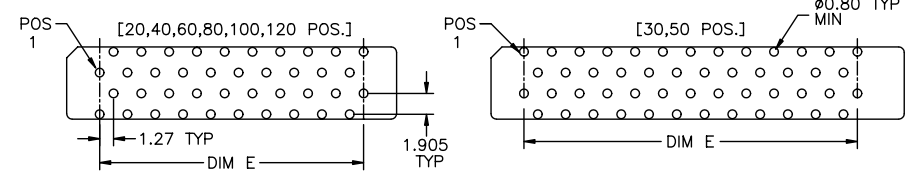

mat'l. code		tolerances unless otherwise specified		CUSTOMER COPY	FCI www.fciconnect.com
ltr	ecr no	dr	date	linear	
J				.X ± 0.3	MM
				.XX ± 0.13	
				.XXX ± 0.05	
				angles	0° ± 2°
		dr	KENNY TAI 05/09/01		product family MODULEMATE
		enr	KENNY TAI 05/09/01		size
		chr	KENNY TAI 05/09/01	scale	A3
		appd	PAUL WANG 05/09/01		95747
sheet index	revision sheet				code
					4 of

All rights reserved. Reproduction or use in any form without the prior written permission of FCI is prohibited. FCI, the FCI logo, and the FCI logo with the text "FCI" are trademarks of FCI. © 2010 FCI. All rights reserved.

PRODUCT NO.	POS.	DIM A	DIM B	DIM E	COMMENTS
95757-028	20	25.43	20.32	11.43	NOT TOOLED
-038	30	31.78	26.67	17.78	
-048	40	38.13	33.02	24.13	
-058	50	44.48	39.37	30.48	
-068	60	50.83	45.72	36.83	
-088	80	63.53	58.42	49.53	
95757-128	120	88.93	83.82	74.93	

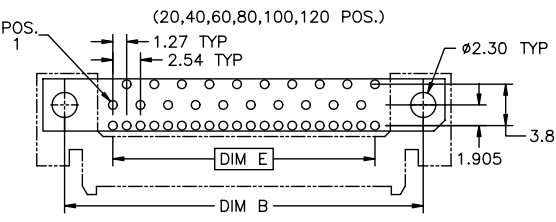

RIGHT ANGLE RECEPTACLE WITH HOOK SHOWN ON THIS SHEET

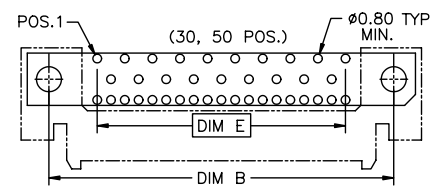

RECOMMENDED PCB LAYOUT

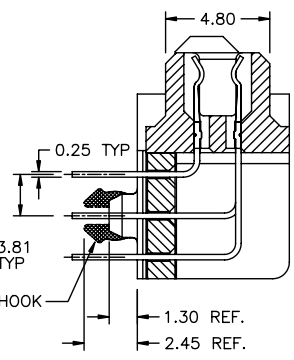
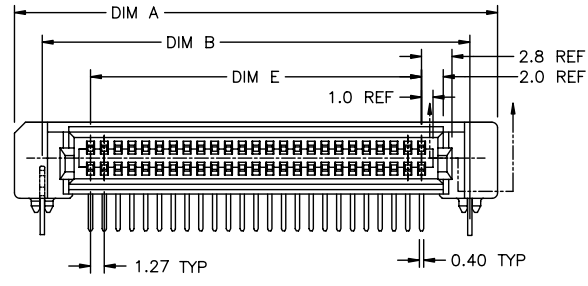

SECTION X-X  
4/1

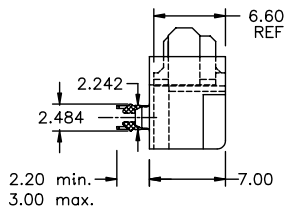

mat'l. code		tolerances unless otherwise specified		CUSTOMER COPY	www.fciconnect.com
ltr	scn no	dr	date	linear	
J				.X ± 0.3	MM
				.XX ± 0.13	title
				.XXX ± 0.05	MODULEMATE
				angles	CONNECTOR ASSEMBLY
				0°±2°	product family
		dr	KENNY TAI 05/09/01	MM	MODULEMATE
		enrg	KENNY TAI 05/09/01	scale	code
		chr	KENNY TAI 05/09/01	A3	95747
		appd	PAUL WANG 05/09/01	size	dwg no
sheet	revision				
index	sheet				

PRODUCT NO.	POS.	DIM A	DIM B	DIM E	COMMENTS
95747-028/028LF	20	25.43	20.32	11.43	AVAILABLE
-038	30	31.78	26.67	17.78	NOT TOOLED
-048	40	38.13	33.02	24.13	AVAILABLE
-058	50	44.48	39.37	30.48	
-068	60	50.83	45.72	36.83	
-088	80	63.53	58.42	49.53	NOT TOOLED
-108	100	76.23	71.12	62.23	
95747-128	120	88.93	83.82	74.93	

RIGHT ANGLE HEADER WITH HOOK  
SHOWN ON THIS SHEET

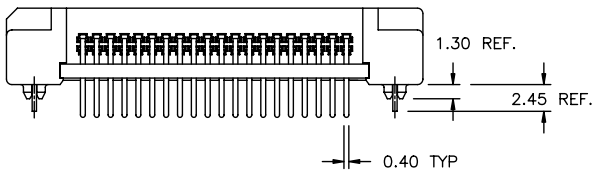
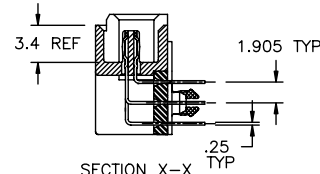
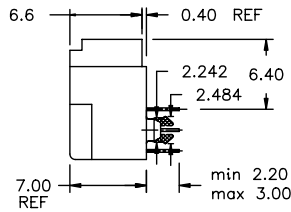
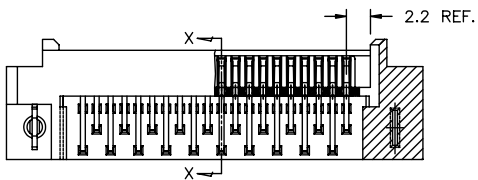
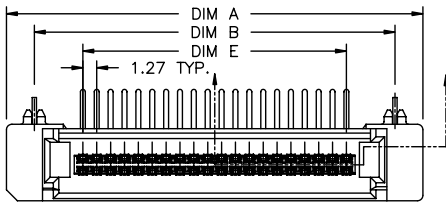
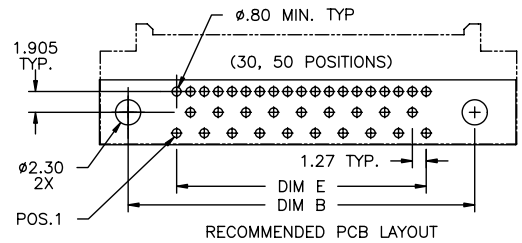
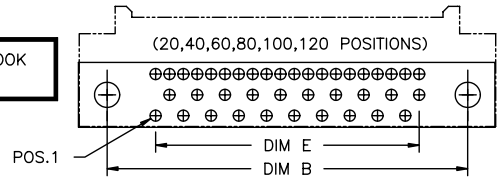

mat'l. code		tolerances unless otherwise specified		CUSTOMER COPY		FCI www.fciconnect.com	
ltr	ecm no	dr	date	linear	.X ± 0.3	projection	title MODULEMATE CONNECTOR ASSEMBLY
K					.XX ± 0.13	MM	
				angles	.XXX ± 0.05	scale	product family MODULEMATE code size dwg no
					0°±2°	A3	
		dr	KENNY TAI 05/09/01				95747
		enr	KENNY TAI 05/09/01				
		chr	KENNY TAI 05/09/01				
		appd	PAUL WANG 05/09/01				sheet 6 of
sheet	revision						
index	sheet						

PRODUCT NO.	POS.	DIM A	DIM B	DIM E	STYLE	COMMENTS
95748-025	20	25.43	20.32	11.43	STYLE I	NOT TOOLED
-035	30	31.78	26.67	17.78		
-045	40	38.13	33.02	24.13		
-055	50	44.48	39.37	30.48		
-065	60	50.83	45.72	36.83		
-085	80	63.53	58.42	49.53		
-105	100	76.23	71.12	62.23		
95748-125	120	88.93	83.82	74.93	STYLE II	
95748-027	20	25.43	20.32	11.43		
-037	30	31.78	26.67	17.78		
-047	40	38.13	33.02	24.13		
-057	50	44.48	39.37	30.48		
-067	60	50.83	45.72	36.83		
-087	80	63.53	58.42	49.53		
-107	100	76.23	71.12	62.23		
95748-127	120	88.93	83.82	74.93		

VERTICLE HEADER WITH HOOK SHOWN ON THIS SHEET

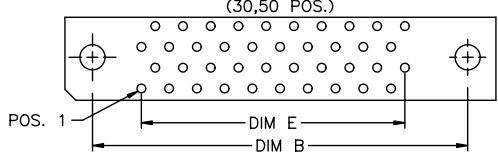
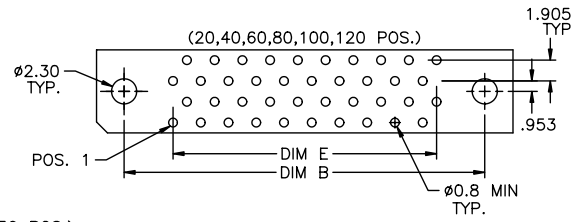

RECOMMENDED PCB LAYOUT

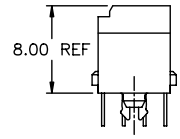
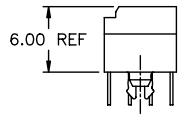
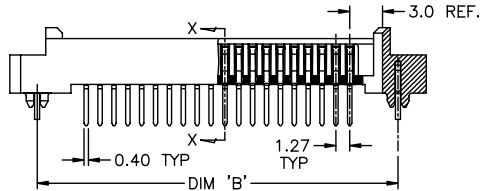
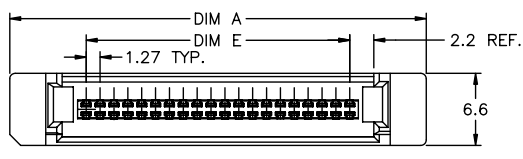

STYLE I

STYLE II

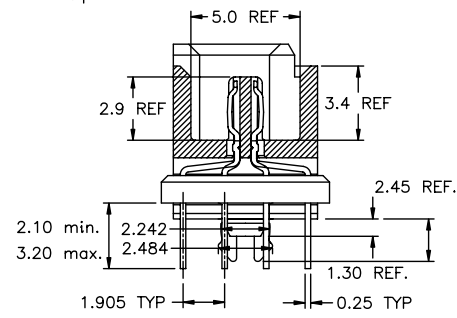

SECTION X-X

mat'l. code		tolerances unless otherwise specified		CUSTOMER COPY		FCJ www.fcjconnect.com	
ltr	ecr no	dr	date	linear	.X ± 0.3	projection	title
J					.XX ± 0.13	MM	MODULEMATE CONNECTOR ASSEMBLY
				angles	.XXX ± 0.05		product family
					0° ± 2°		MODULEMATE
				dr	KENNY TAI 05/09/01		code
				enr	KENNY TAI 05/09/01		size
				chr	KENNY TAI 05/09/01	scale	dwg no
				appd	PAUL WANG 05/09/01	---	95747
sheet	revision						
index	sheet						7 of

PRODUCT NO.	POS.	DIM A	DIM E	STYLE	COMMENTS	
95749-025	20	18.83	14.23	STYLE I	NOT TOOLED	
-035	30	25.48	20.58			
-045	40	31.53	26.93			
-055	50	37.88	33.28			
-065	60	44.23	39.63			
-085	80	56.93	52.33			
-105	100	69.63	65.03			
-125	120	82.33	77.73			
-027	20	18.83	14.23			STYLE II
-037	30	25.48	20.58			
-047	40	31.53	26.93			
-057	50	37.88	33.28			
-067	60	44.23	39.63			
-087	80	56.93	52.33			
-107	100	69.63	65.03			
95749-127	120	82.33	77.73			

VERTICLE HEADER WITHOUT HOOK SHOWN ON THIS SHEET

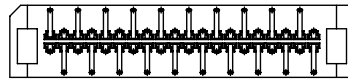
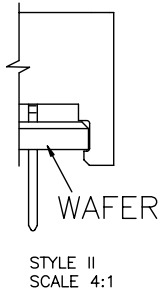
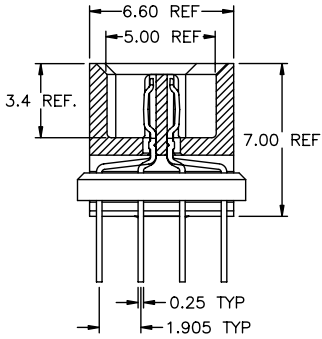
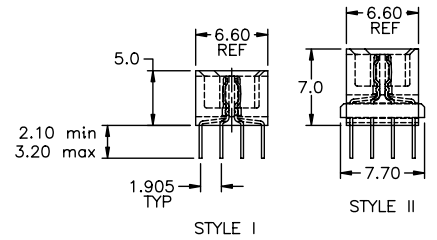
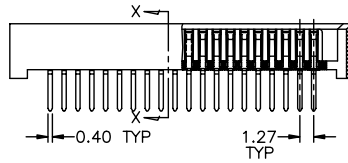
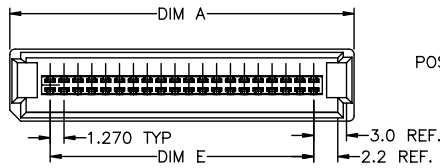
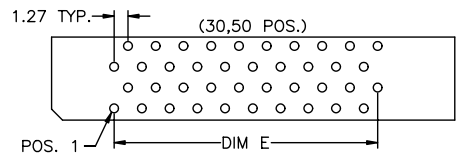
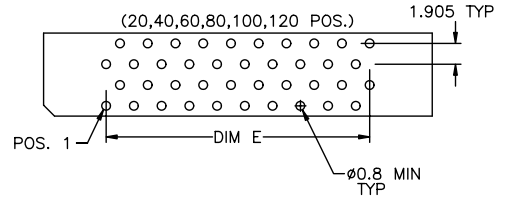

mat'l. code		tolerances unless otherwise specified		CUSTOMER COPY		FCJ www.fcjconnect.com	
ltr	ecm no	dr	date	linear	.X ± 0.3	projection	title
J					.XX ± 0.13	MM	MODULEMATE CONNECTOR ASSEMBLY
				angles	.XXX ± 0.05	MM	product family MODULEMATE code
					0°±2°	MM	size
dr	KENNY TAI	05/09/01		scale	---	A3	95747
enr	KENNY TAI	05/09/01					8 of
chr	KENNY TAI	05/09/01					
appd	PAUL WANG	05/09/01					
sheet index	revision sheet						

PDM! Rev:K STATUS:Released Printed: Nov 09, 2010 6