

Tous droits strictement réservés. Reproduction ou communication à des tiers interdite sous quelque forme que ce soit sans autorisation écrite du propriétaire. Property of FCI. Copyright FCI.

All rights strictly reserved. Reproduction or issue to third parties in any form whatever is not permitted without written authority from the proprietor. Property of FCI. Copyright FCI.

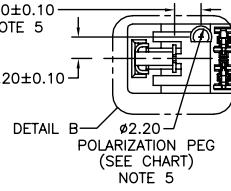

SHORTENED STANDOFF ON 72436-XXXX AND OPTION DESIGN FOR 72436-XXXLF

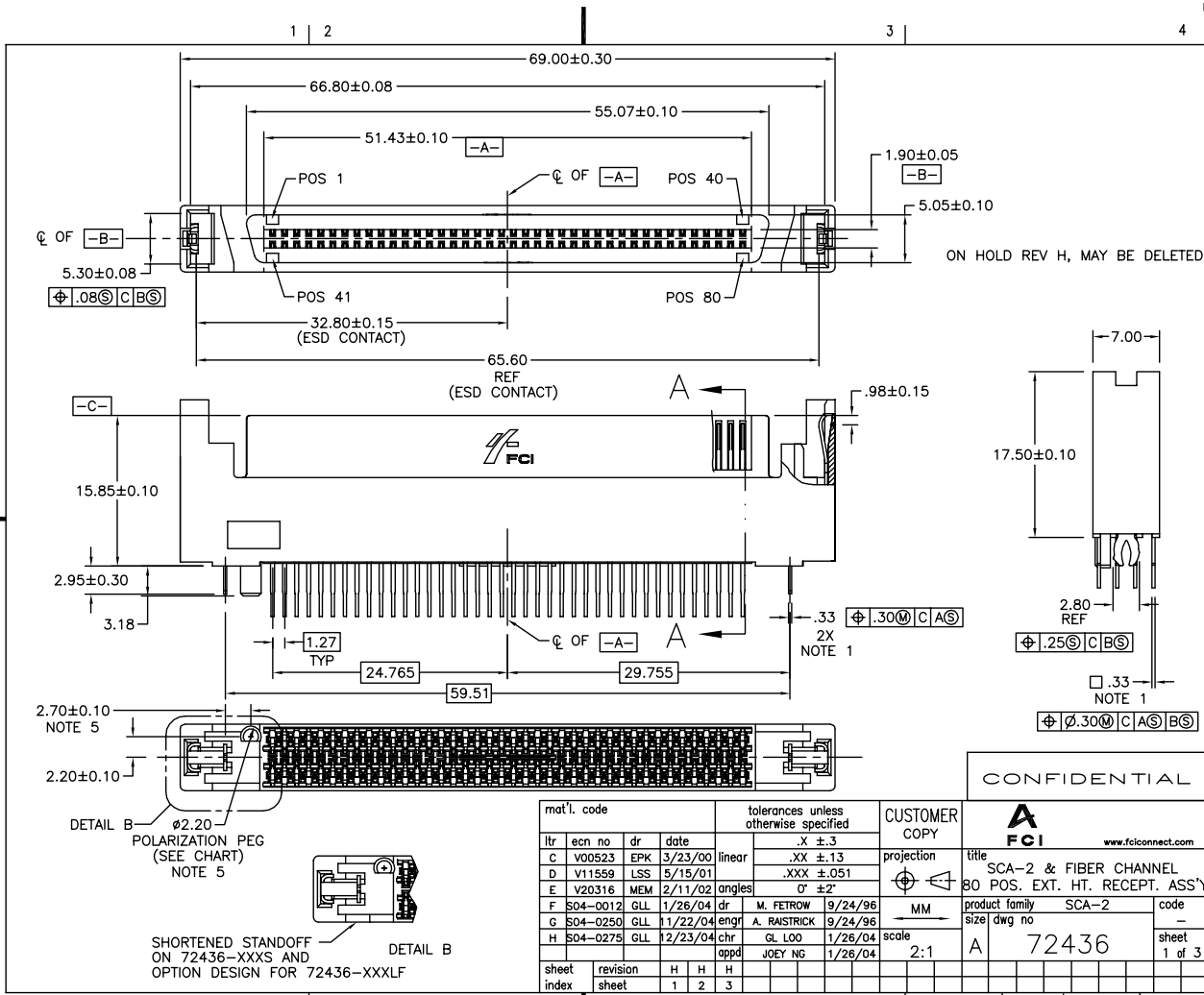
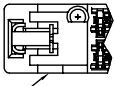

CONFIDENTIAL

mat'l. code		tolerances unless otherwise specified			CUSTOMER COPY		FCI www.fciconnect.com	
ltr	ecn no	dr	date	linear	.X ±.3	projection	title	
C	V00523	EPK	3/23/00		.XX ±.13		SCA-2 & FIBER CHANNEL	
D	V11559	LSS	5/15/01		.XXX ±.051		80 POS. EXT. HT. RECEPT. ASS'Y	
E	V20316	MEM	2/11/02	angles	Ø ±.2		product family	SCA-2
F	S04-0012	GLL	1/26/04	dr	M. FETROW	9/24/96	size	dwg no
G	S04-0250	GLL	11/22/04	engr	A. RAISTRICK	9/24/96	scale	2:1
H	S04-0275	GLL	12/23/04	chr	GL LOO	1/26/04	sheet	1 of 3
		appd			JOEY NG	1/26/04		
sheet index	revision sheet	H	H	H			cage code	22526
		1	2	3				

ACAD

PDM: Rev:H STATUS:Released Printed: May 26, 2010

Tous droits strictement réservés. Reproduction ou communication à des tiers interdite sous quelque forme que ce soit sans autorisation écrite du propriétaire. Property of FCI. Copyright FCI.

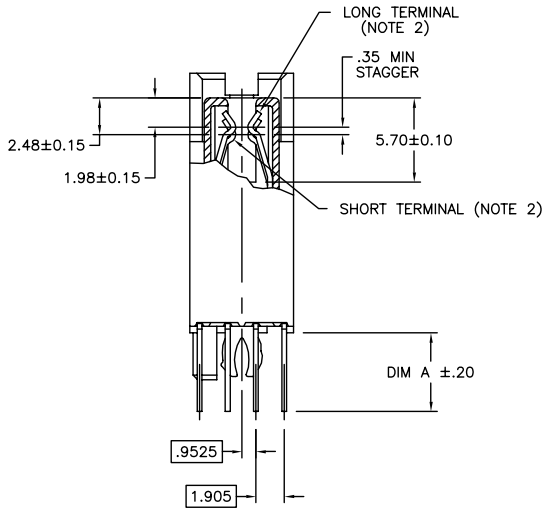

All rights strictly reserved. Reproduction or issue to third parties in any form whatsoever is not permitted without written authority from the proprietor. Property of FCI. Copyright FCI.

1 | 2 | 3 | 4



SECTION A-A

CONFIDENTIAL

mat'l. code		tolerances unless otherwise specified		CUSTOMER COPY		 www.fciconnect.com	
ltr	ecr no	dr	date	linear	.X ±.3	projection	title
H					.XX ±.13		SCA-2 & FIBER CHANNEL
				angles	.XXX ±.051		80 POS. EXT. HT. RECEPT. ASS'Y
				dr	σ ±2	MM	product family
				enfr	M. FETROW 9/24/96	scale	SCA-2
				chr	A. RAISTRICK 9/24/96	3:1	size
				appd	GL LOO 1/26/04	A	72436
					JOEY NG 1/26/04		sheet
sheet index	revision sheet	1					2 of 3

1 | 2 | 3 | 4

ACAD

cage code 22526

PDM: Rev:H STATUS:Released Printed: May 26, 2010

Tous droits strictement réservés. Reproduction ou communication à des tiers interdite sous quelque forme que ce soit sans autorisation écrite du propriétaire. Property of FCI. Droits de reproduction FCI.

All rights strictly reserved. Reproduction or issue to third parties in any form whatever is not permitted without written authority from the proprietor. Property of FCI. Copyright FCI.

PRODUCT NO. SEE NOTE 7	"A" DIM	POLARIZATION PEG	PLATING	RECOMMENDED P.C. BOARD THICKNESS	PRODUCT NO.	PLATING	PRODUCT NO.	PLATING	PRODUCT NO.	PLATING	
72436-001	2.79	YES	NOTE 4	1.57mm (0.062")	72436-101	NOTE 6	72436-001LF	NOTE 9	72436-201LF	NOTE 8	
-001S					-101S				-002LF		-202LF
-002	2.79	NO			-102S						
-002S					-103				72436-003LF		72436-203LF
-003	3.18	YES			-103S						
-003S					-104				-004LF		-204LF
-004	3.18	NO			-104S						
-004S					-105						
-005	4.06	YES			-105S						
-005S					-106						
-006	4.06	NO			-106S						
72436-006S					72436-106S						

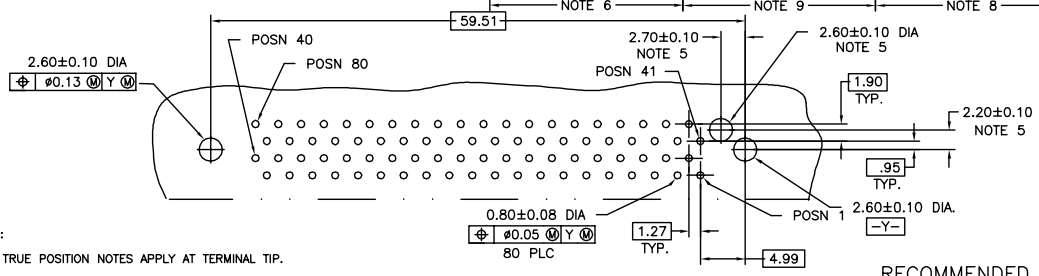

NOTES :

- TRUE POSITION NOTES APPLY AT TERMINAL TIP.
- CONTACTS IN POSITIONS 2 THRU 35, 44 AND 47 THRU 74 ARE SHORT TERMINALS. CONTACTS IN POSITIONS 1, 36 THRU 43, 45, 46, AND 75 THRU 80 ARE LONG TERMINALS.
- RAW MATERIALS: HOUSING: HTN, UL94V-0, COLOR: BLACK CONTACTS: PHOSPHOR-BRONZE
- CONTACT PLATING: 30u" (0.76um) MIN. GXT PLATING OVER 50u" (1.27um) NICKEL MIN. UNDERPLATE IN CONTACT AREA. 100u" (2.54um) MIN. TIN-LEAD PLATING OVER 50u" (1.27um) MIN. NICKEL UNDERPLATE IN P.C. BOARD LEG AREA. 50u" (1.27um) MIN. NICKEL UNDERPLATE OVER REMAINING AREA.
- DIMENSIONS DO NOT APPLY TO CONNECTOR STYLES WITHOUT POLARIZATION PEG. (SEE CHART)
- CONTACT PLATING: 30u" (0.76um) MIN. GOLD PLATING OVER 50u" (1.27um) NICKEL MIN. UNDERPLATE IN CONTACT AREA. 100u" (2.54um) MIN. TIN-LEAD PLATING OVER 50u" (1.27um) MIN. NICKEL UNDERPLATE IN P.C.B. LEG AREA. 50u" (1.27um) MIN. NICKEL UNDERPLATE OVER REMAINING AREA.
- PART NUMBERS WITH "S" SUFFIX ARE MANUFACTURED WITH BRIGHT TIN-LEAD FINISH ON THE TERMINAL TAIL SECTION. PART NUMBERS WITHOUT AN END SUFFIX ARE MANUFACTURED WITH MATTE TIN-LEAD FINISH.
- CONTACT PLATING: 30u" (0.76um) GOLD PLATING OVER 50u" (1.27um) NICKEL UNDERPLATE IN CONTACT AREA. 100u" (2.54um) MIN. TIN-LEAD PLATING OVER 50u" (1.27um) MIN. NICKEL UNDERPLATE IN P.C. BOARD LEG AREA. 50u" (1.27um) MIN. NICKEL UNDERPLATE OVER REMAINING AREA.

- CONTACT PLATING: 30u" (0.76um) GXT PLATING OVER 50u" (1.27um) NICKEL UNDERPLATE IN CONTACT AREA. 100u" (2.54um) MIN. TIN-LEAD PLATING OVER 50u" (1.27um) MIN. NICKEL UNDERPLATE IN P.C. BOARD LEG AREA. 50u" (1.27um) NICKEL UNDERPLATE OVER REMAINING AREA.
- THE HOUSING WILL WITHSTAND EXPOSURE TO 260° C PEAK TEMPERATURE FOR 10 SECONDS IN A WAVE SOLDER APPLICATION WITH A 1.57MM THICK CIRCUIT BOARD.
- THIS PRODUCT MEETS EUROPEAN UNION DIRECTIVES AND OTHER COUNTRY REGULATIONS AS DESCRIBED IN GS-22-008.
- PART NUMBERS ENDING IN "LF" MEANS FOR NOTE 11 LEAD FREE IDENTIFICATION. P/N XXXXX-2XXLF IS EQUIVALENT TO PREVIOUS P/N XXXXX-2XX

RECOMMENDED PC BOARD MOUNTING DIMENSIONS COMPONENT SIDE

CONFIDENTIAL

mat'l. code				tolerances unless otherwise specified		CUSTOMER COPY	
ltr	ecn no	dr	date	linear	.X ±.3	projection	
H					.XX ±.13		
				angles	.XXX ±.051		
				dr	σ ±2		
				enrg	M. FETROW 9/24/96	MM	
				chr	A. RAISTRICK 9/24/96		
				appd	GL LOO 1/26/04	scale	2:1
					JOEY NG 1/26/04		
sheet index	revision sheet	1					

FCI www.fciconnect.com	
title	SCA-2 & FIBER CHANNEL 80 POS. EXT. HT. RECEPT. ASS'Y
product family	SCA-2
size	dwg no
A	72436
code	-
sheet	3 of 3

cage code 22526

ACAD