

NO. OF CONTACTS : 40,60,68,80,100,120
CRITERION PIN

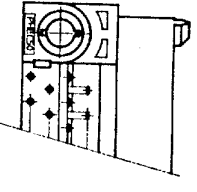
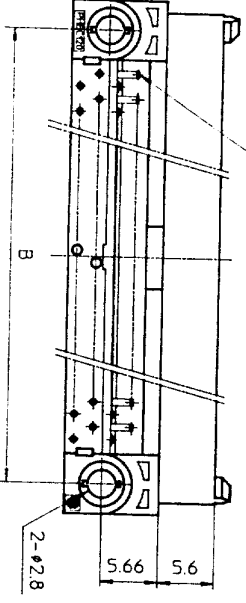

| CAT. NO. | NO. OF CONTACTS (MATING SIDE) | DIMENSIONS | | | | |
|--------------|-------------------------------|------------|-------|-------|-------|-------|
| | | A | B | C | D | E |
| PHEC30P-R21 | 15/ROW X 2 ROWS | 32.67 | 26.67 | 30.3 | 20.42 | 17.78 |
| PHEC34P-R21 | 17/ROW X 2 ROWS | 35.21 | 29.21 | 32.84 | 22.96 | 20.32 |
| PHEC40P-R21 | 20/ROW X 2 ROWS | 39.02 | 33.02 | 36.65 | 26.77 | 24.13 |
| PHEC50P-R21 | 25/ROW X 2 ROWS | 45.37 | 39.37 | 43 | 33.12 | 30.48 |
| PHEC60P-R21 | 30/ROW X 2 ROWS | 51.72 | 45.72 | 49.35 | 39.47 | 36.83 |
| PHEC68P-R21 | 34/ROW X 2 ROWS | 56.8 | 50.8 | 54.43 | 44.55 | 41.91 |
| PHEC80P-R21 | 40/ROW X 2 ROWS | 64.42 | 58.42 | 62.05 | 52.17 | 49.53 |
| PHEC100P-R21 | 50/ROW X 2 ROWS | 77.12 | 71.12 | 74.75 | 64.87 | 62.23 |
| PHEC120P-R21 | 60/ROW X 2 ROWS | 89.82 | 83.82 | 87.45 | 77.57 | 74.93 |

TOLERANCES UNLESS OTHERWISE SPECIFIED: ±0.3

MATERIAL : NYLON RESIN GLASS REINFORCED (UL94V-0)
BODY COLOR : BLACK
LOCATOR : PBT RESIN GLASS REINFORCED (UL94V-0)
COLOR : BLACK
CONTACT : COPPER ALLOY
MOUNTING LATCH : PHOSPHOR BRONZE
SOLDER PLATED
SCREW NUT : STEEL
NICKEL PLATED

CONTACT PLATING TABLE (THICKNESS: μm)

| CONTACT AREA | REMAINDER |
|----------------------------------|-----------------------|
| GOLD 0.25 MIN. OVER NICKEL 3Z | SOLDER OVER NICKEL |

DRAWING NO. JSC 90736

| REV | DATE | DESCRIPTION | CKD | SCALE | DIM. IN | MATERIAL | DESIGNED | DRAWN | CHECKED | APPROVED | DATE | PRINTED CIRCUIT CONNECTOR | CAT. NO. | DRAWING NO. | REV |
|-----------|------|---|-----|-------|---------|----------|----------|-------|---------|----------|------|---------------------------|------------|-------------|-----|
| 92 | 8-14 | 30,34,50,68 POSITIONS ADDED. LOCATOR MATERIAL ADDED. | | | | | | | | | | | PHEC_P-R21 | JSC 90736 | 3 |
| 2 | 6-7 | EC 7866 | | | | | | | | | | | | | |
| 1 | 4-20 | EC 7837 | | | | | | | | | | | | | |
| REV | DATE | DESCRIPTION | CKD | SCALE | DIM. IN | MATERIAL | DESIGNED | DRAWN | CHECKED | APPROVED | DATE | PRINTED CIRCUIT CONNECTOR | CAT. NO. | DRAWING NO. | REV |
| REFERENCE | | | | | | | | | | | | | | | |



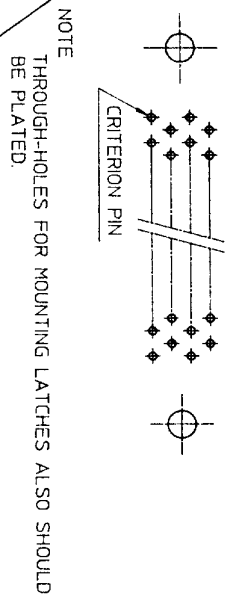
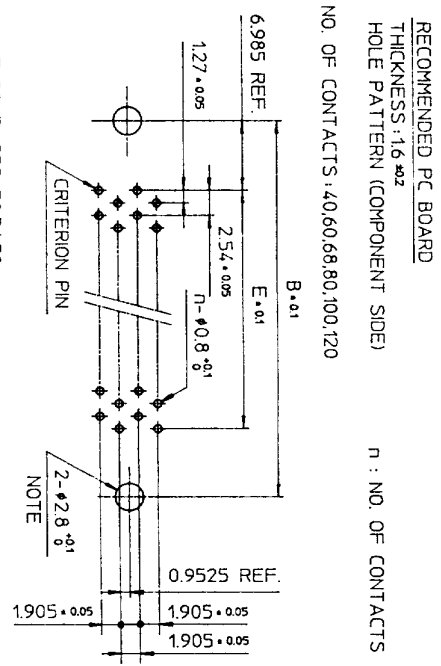
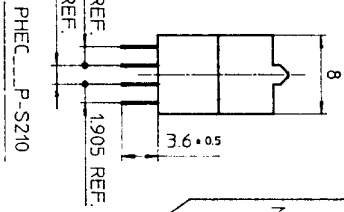
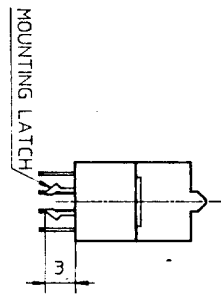
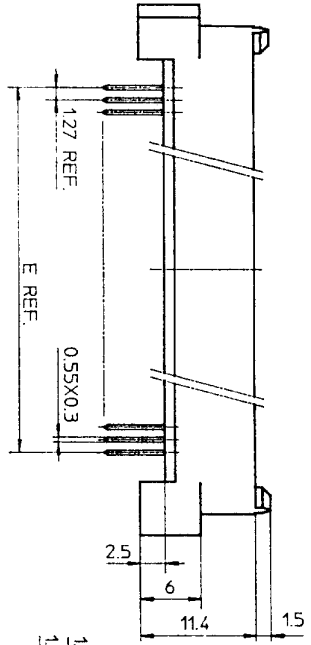
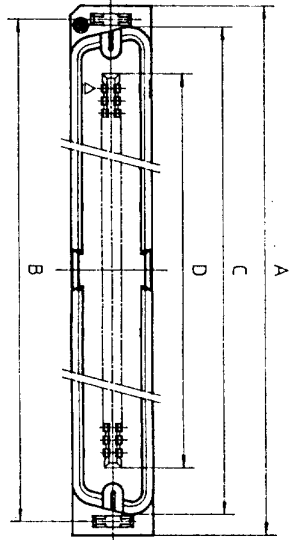

TOLERANCES UNLESS OTHERWISE SPECIFIED: ±0.3

NO. OF CONTACTS: 40,60,68,80,100,120

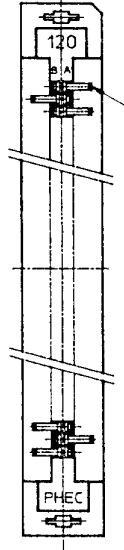

NO. OF CONTACTS: 30,34,50

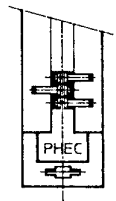

MATERIAL

INSULATOR : NYLON RESIN GLASS REINFORCED (UL94V-0)
 COLOR : BLACK
 CONTACT : COPPER ALLOY
 MOUNTING LATCH : PHOSPHOR BRONZE
 SOLDER PLATED

| CAT. NO. | NO. OF CONTACTS (MATING SIDE) | DIMENSIONS | | | | |
|---------------|-------------------------------|------------|-------|-------|-------|-------|
| | | A | B | C | D | E |
| PHEC30P-S21L | 15/ROW X 2 ROWS | 34.55 | 31.75 | 30.3 | 20.42 | 17.78 |
| PHEC34P-S21L | 17/ROW X 2 ROWS | 37.09 | 34.29 | 32.84 | 22.96 | 20.32 |
| PHEC40P-S21L | 20/ROW X 2 ROWS | 40.9 | 38.1 | 36.65 | 26.77 | 24.13 |
| PHEC50P-S21L | 25/ROW X 2 ROWS | 47.25 | 44.45 | 43 | 33.12 | 30.48 |
| PHEC60P-S21L | 30/ROW X 2 ROWS | 53.6 | 50.8 | 49.35 | 39.47 | 36.83 |
| PHEC68P-S21L | 34/ROW X 2 ROWS | 58.68 | 55.88 | 54.43 | 44.55 | 41.91 |
| PHEC80P-S21L | 40/ROW X 2 ROWS | 66.3 | 63.5 | 62.05 | 52.17 | 49.53 |
| PHEC100P-S21L | 50/ROW X 2 ROWS | 79.0 | 76.2 | 74.75 | 64.87 | 62.23 |
| PHEC120P-S21L | 60/ROW X 2 ROWS | 91.7 | 88.9 | 87.45 | 77.57 | 74.93 |

CONTACT PLATING TABLE [THICKNESS: μm]

| CONTACT AREA | REMAINDER |
|-----------------|-------------|
| GOLD 0.25 MIN | SOLDER |
| OVER NICKEL 3.2 | OVER NICKEL |

PRINTED CIRCUIT CONNECTOR
 CAT. NO. PHEC_P-S21L
 DRAWING NO. JSC 90735
 REV. 3
BURNDY JAPAN, Ltd.

DESIGNED
 DRAWN *M. Oba*
 CHECKED *A. Eb*
 APPROVED *J. Nakagishi*
 DATE Mar. 8, 1990

SCALE
 DIM. IN mm
 MATERIAL

| REV. | DATE | DESCRIPTION | CHKD. |
|------|----------|------------------------------|-----------|
| 3 | '92-8-11 | 30,34,50,68 POSITIONS ADDED. | <i>JK</i> |
| 2 | '90-6-5 | EC 7866 | <i>JK</i> |
| 1 | '90-4-20 | EC 7837 | <i>JK</i> |

DRAWING NO. JSC 90735

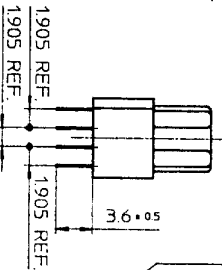
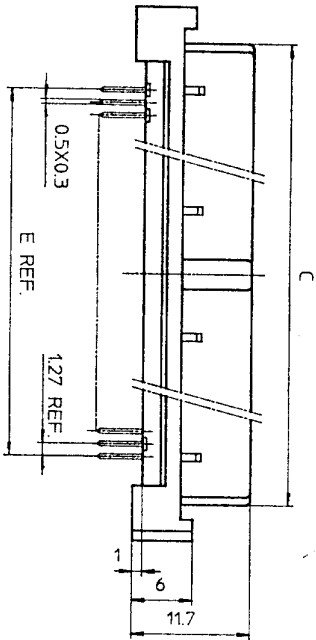
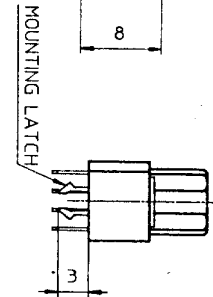
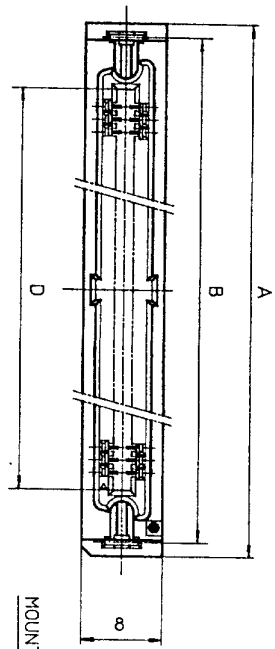

PHEC...R-S210

PHEC...R-S211

RECOMMENDED PC BOARD
THICKNESS: 1.6 ± 0.2
HOLE PATTERN (COMPONENT SIDE)
NO. OF CONTACTS: 40, 60, 68, 80, 100, 120
n : NO. OF CONTACTS

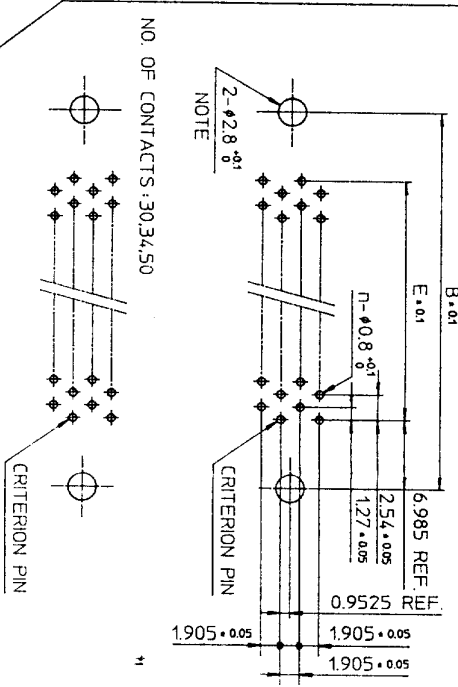

NOTE
THROUGH-HOLES FOR MOUNTING LATCHES ALSO SHOULD BE PLATED.

TOLERANCES
UNLESS OTHERWISE SPECIFIED: ±0.3

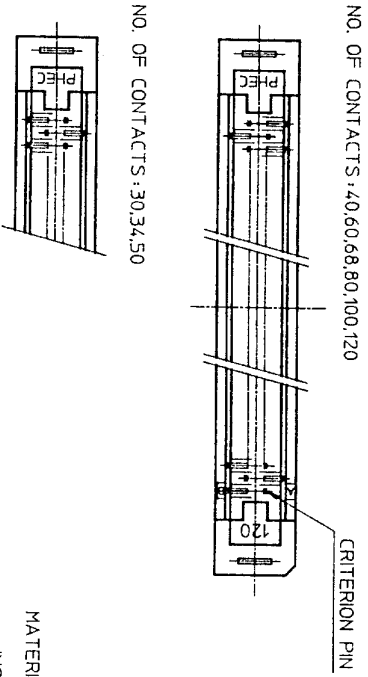

| CAT. NO. | NO. OF CONTACTS (MATING SIDE) | DIMENSIONS | | | | |
|--------------|-------------------------------|------------|-------|-------|-------|-------|
| | | A | B | C | D | E |
| PHEC30R-S21 | 15/ROW X 2 ROWS | 34.55 | 31.75 | 27.26 | 21.26 | 17.78 |
| PHEC34R-S21 | 17/ROW X 2 ROWS | 37.09 | 34.29 | 29.8 | 23.8 | 20.32 |
| PHEC40R-S21 | 20/ROW X 2 ROWS | 40.9 | 38.1 | 33.61 | 27.61 | 24.13 |
| PHEC50R-S21 | 25/ROW X 2 ROWS | 47.25 | 44.45 | 39.96 | 33.96 | 30.48 |
| PHEC60R-S21 | 30/ROW X 2 ROWS | 53.6 | 50.8 | 46.31 | 40.31 | 36.83 |
| PHEC68R-S21 | 34/ROW X 2 ROWS | 58.68 | 55.88 | 51.39 | 45.39 | 41.91 |
| PHEC80R-S21 | 40/ROW X 2 ROWS | 66.3 | 63.5 | 59.01 | 53.01 | 49.53 |
| PHEC100R-S21 | 50/ROW X 2 ROWS | 79.0 | 76.2 | 71.71 | 65.71 | 62.23 |
| PHEC120R-S21 | 60/ROW X 2 ROWS | 91.7 | 88.9 | 84.41 | 78.41 | 74.93 |

MATERIAL

INSULATOR: PBT RESIN GLASS REINFORCED (UL-94V-0)

COLOR: BLACK

CONTACT: PHOSPHOR BRONZE

MOUNTING LATCH: PHOSPHOR BRONZE
SOLDER PLATED

CONTACT PLATING TABLE

| CONTACT AREA | REMAINDER | SOLDER |
|-----------------------------------|-----------|-------------|
| GOLD 0.25 MIN. OVER NICKEL 3.2 | | OVER NICKEL |

PRINTED CIRCUIT CONNECTOR
CAT. NO. PHEC...R-S21
DRAWING NO. JSC 90737
REV 4
BURNDY JAPAN, Ltd.

DESIGNED
DRAWN M. Oba
CHECKED A. Oba
APPROVED J. Nakagishi
DATE Mar. 8, 1990

SCALE
DIM IN MM
MATERIAL

| REV. DATE | DESCRIPTION | CKD |
|-----------|-------------------------------------|-----|
| 4-1-29 | WRONG CONTACT DIM. CORRECTED. | |
| 3-8-11 | 30,34,50,68 POSITIONS ADDED No. 5.9 | |
| 2-5-30 | EC 7866 No. JK | |
| 1-4-20 | EC 7837 No. JK | |

DRAWING NO. JSC 90737

DRAWING NO.
JSC 90739

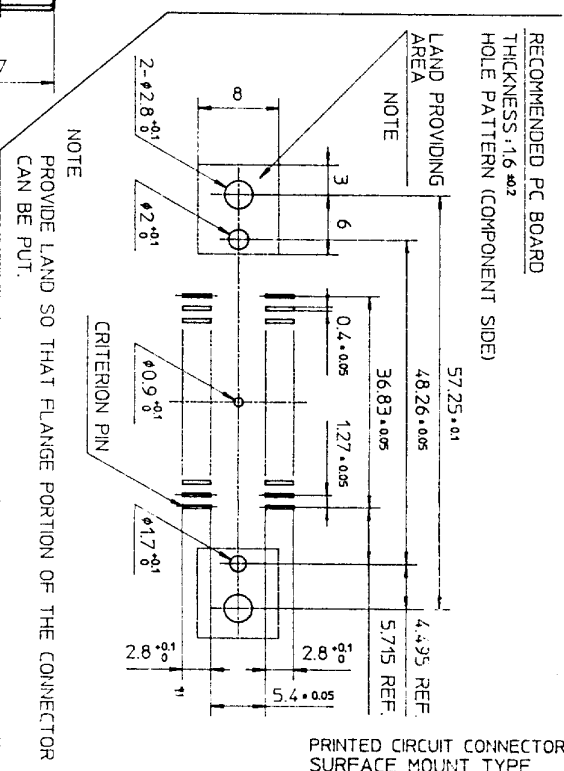
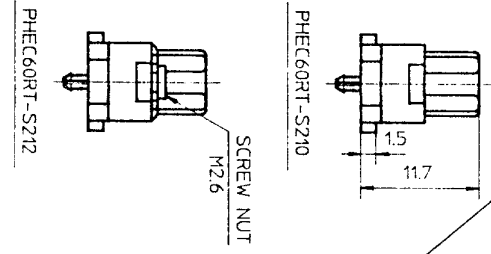
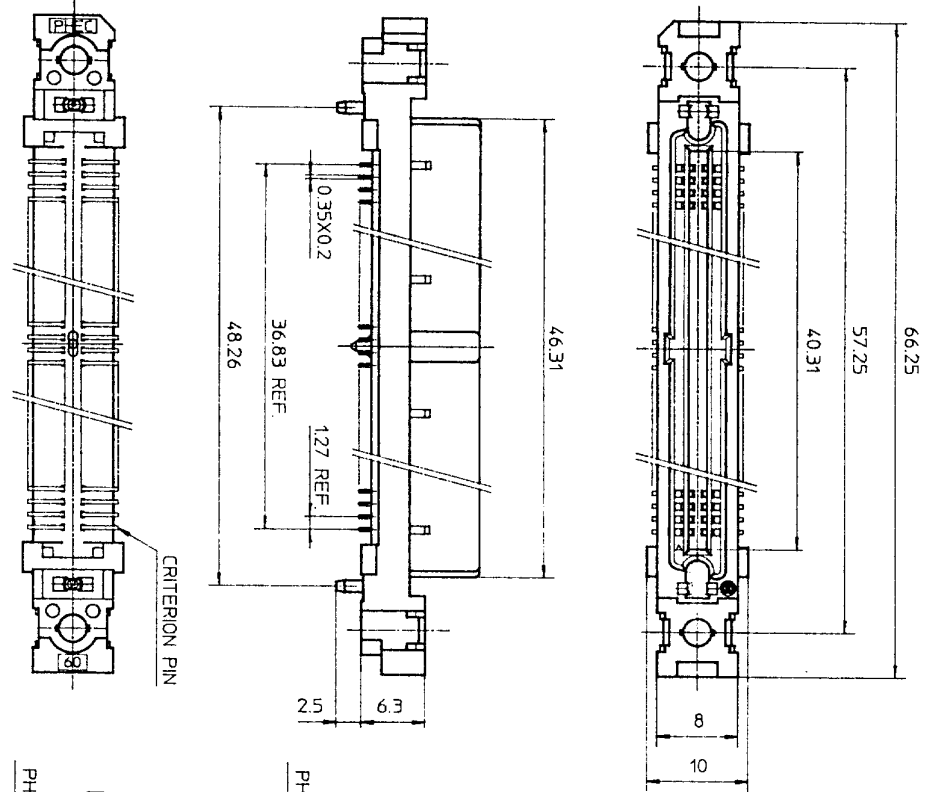

MATERIAL
INSULATOR : PPS RESIN GLASS REINFORCED (UL94V-0)
COLOR : BLACK
CONTACT : PHOSPHOR BRONZE
SCREW NUT : STAINLESS
NO. OF CONTACTS : 30/ROW X 2 ROWS (MATING SIDE)

CONTACT PLATING TABLE
(THICKNESS : μm)

| CONTACT AREA | REMAINDER |
|----------------|-------------|
| GOLD 0.25 MIN. | SOLDER |
| OVER NICKEL 3Z | OVER NICKEL |

TOLERANCES
UNLESS OTHERWISE SPECIFIED : ±0.3

PRINTED CIRCUIT CONNECTOR
SURFACE MOUNT TYPE

| REV | DATE | DESCRIPTION | CHK. |
|-----|----------|---|--------------|
| 4 | '92 8-14 | WRONG CONTACT DIM. CORRECTED 100 POSITIONS OF DELETED. | M. Oba |
| 3 | '92 1-8 | DIM. CHANGED. | J. Kobayashi |
| 2 | '90 6-8 | EC7866 | J. Kobayashi |
| 1 | '90 4-20 | VARIATION ADDED. | J. Kobayashi |

| | |
|----------|-----|
| SCALE | 1:1 |
| DIM IN | mm |
| MATERIAL | |

| | |
|----------|--------------|
| DESIGNED | |
| DRAWN | M. Oba |
| CHECKED | J. Kobayashi |
| APPROVED | J. Kobayashi |
| DATE | Mar. 8, 1990 |

| | |
|-------------|---------------|
| CAT. NO. | PHEC60RT-S212 |
| DRAWING NO. | JSC 90739 |
| REV | 4 |
| | |

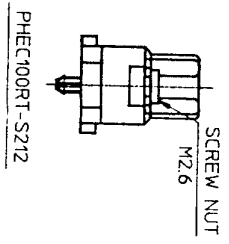
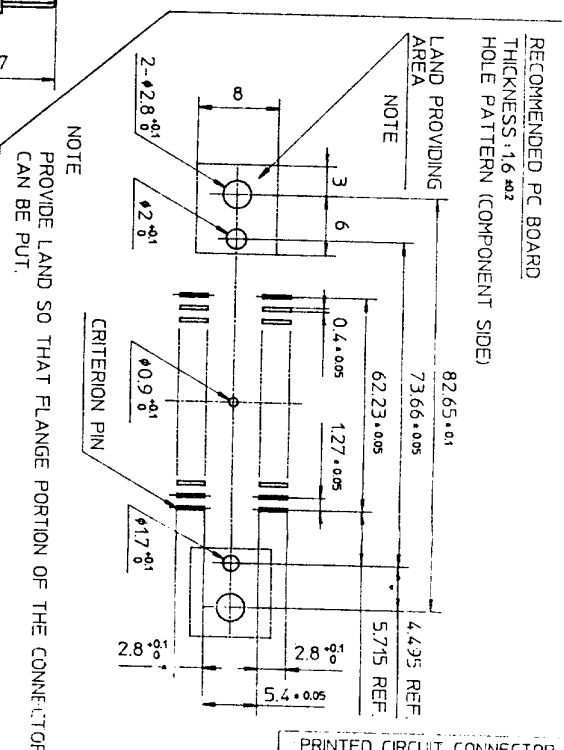
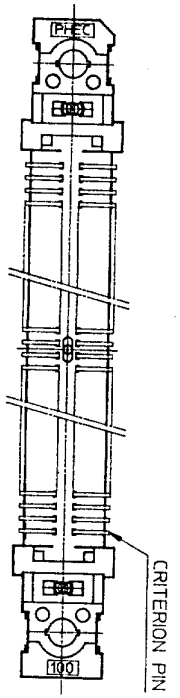
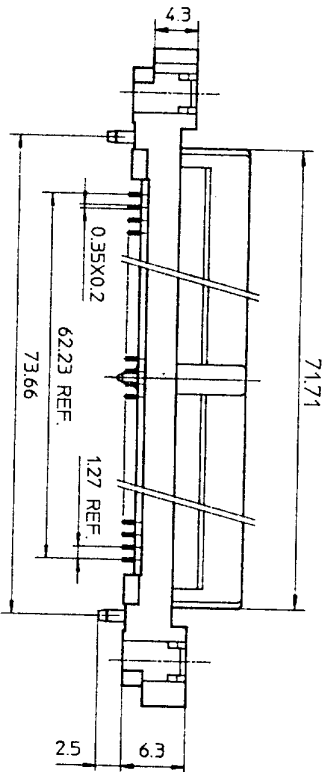
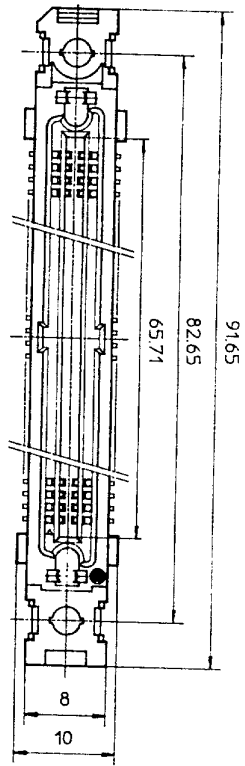

TOLERANCES UNLESS OTHERWISE SPECIFIED : ±0.3

MATERIAL
 INSULATOR : PPS RESIN GLASS REINFORCED (UL94V-0)
 COLOR : BLACK
 CONTACT : PHOSPHOR BRONZE
 SCREW NUT : STAINLESS
 NO. OF CONTACTS : 50/ROW X 2 ROWS (MATING SIDE)

CONTACT PLATING TABLE (THICKNESS: μm)

| | |
|----------------------------------|-----------------------|
| CONTACT AREA | REMAINDER |
| GOLD 0.25 MIN OVER NICKEL 3.2 | SOLDER OVER NICKEL |

PRINTED CIRCUIT CONNECTOR SURFACE MOUNT TYPE

CAT. NO. PHEC100RT-S21L

DRAWING NO. JSC 91839 REV. 0

BURNDY JAPAN Ltd.

DESIGNED BY
 DRAWN BY
 CHECKED BY
 APPROVED BY
 DATE Aug. 11, 1992

SCALE
 DIM. IN
 MATERIAL

| REV. | DATE | DESCRIPTION | CHKD. |
|------|------|-------------|-------|
| | | | |

DRAWING NO. JSC 91839

DRAWING NO. JSC 90752

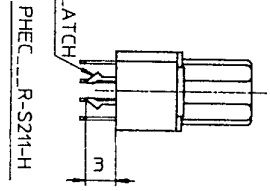
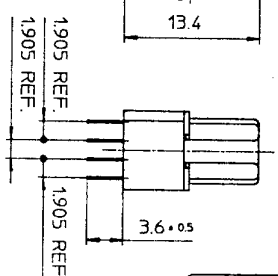
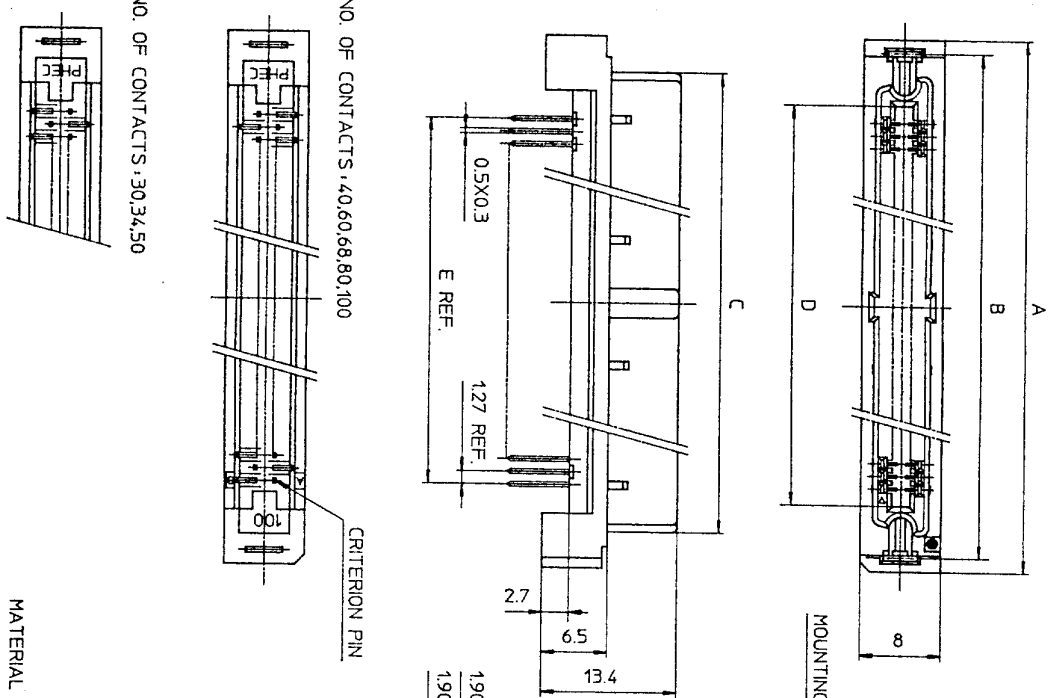

PHEC...R-S210-H

PHEC...R-S211-H

NO. OF CONTACTS : 40,60,68,80,100

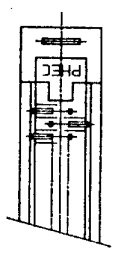

NO. OF CONTACTS : 30,34,50

RECOMMENDED PC BOARD THICKNESS : 1.6 ±0.2

HOLE PATTERN (COMPONENT SIDE)

NO. OF CONTACTS : 40,60,68,80,100

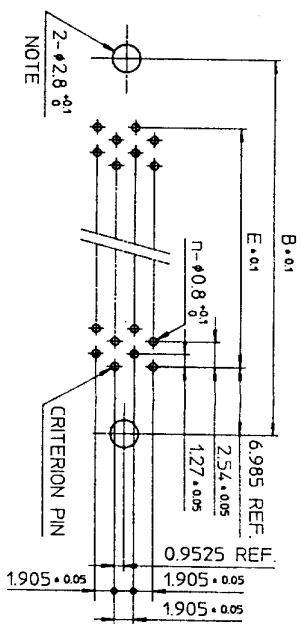

NO. OF CONTACTS : 30,34,50

NOTE THROUGH-HOLES FOR MOUNTING LATCHES ALSO SHOULD BE PLATED.

TOLERANCES UNLESS OTHERWISE SPECIFIED, ±0.3

| CAT. NO. | NO. OF CONTACTS (MATING SIDE) | DIMENSIONS | | | | |
|----------------|-------------------------------|------------|-------|-------|-------|-------|
| | | A | B | C | D | E |
| PHEC30R-S21-H | 15/ROW X 2 ROWS | 34.55 | 31.75 | 27.26 | 21.26 | 17.78 |
| PHEC34R-S21-H | 17/ROW X 2 ROWS | 37.09 | 34.29 | 29.8 | 23.8 | 20.32 |
| PHEC40R-S21-H | 20/ROW X 2 ROWS | 40.9 | 38.1 | 33.61 | 27.61 | 24.13 |
| PHEC50R-S21-H | 25/ROW X 2 ROWS | 47.25 | 44.45 | 39.96 | 33.96 | 30.48 |
| PHEC60R-S21-H | 30/ROW X 2 ROWS | 53.6 | 50.8 | 46.31 | 40.31 | 36.83 |
| PHEC68R-S21-H | 34/ROW X 2 ROWS | 58.68 | 55.88 | 51.99 | 45.99 | 41.91 |
| PHEC80R-S21-H | 40/ROW X 2 ROWS | 66.3 | 63.5 | 59.01 | 53.01 | 49.53 |
| PHEC100R-S21-H | 50/ROW X 2 ROWS | 79.0 | 76.2 | 71.71 | 65.71 | 62.23 |

MATERIAL

INSULATOR : PBT RESIN GLASS REINFORCED (UL94V-0)

COLOR : BLACK

CONTACT : PHOSPHOR BRONZE

MOUNTING LATCH : PHOSPHOR BRONZE
SOLDER PLATED

CONTACT PLATING TABLE

| CONTACT AREA | REMAINDER |
|-----------------|-------------|
| GOLD 0.25 MIN | SOLDER |
| OVER NICKEL 3.2 | OVER NICKEL |

| REV | DATE | DESCRIPTION | CHKD. |
|-----|---------|--|-------|
| 5 | 93-6-22 | 100 POSITIONS ADDED. | M.O |
| 4 | 93-2-1 | WRONG CONTACT DIM. CORRECTED. | 5.9 |
| 3 | 92-8-11 | 100,120 POSITIONS DELETED. 30,34,50,68 POSITIONS ADDED. | 5.9 |
| 2 | 90-5-30 | DIM. CHANGED (36.61 → 33.61) | 5 |
| 1 | 90-5-14 | EC 7866 | HE |

SCALE DIM. IN MATERIAL

DESIGNED
DRAWN M. Oga
CHECKED
APPROVED
DATE Mar. 24, 1990

PRINTED CIRCUIT CONNECTOR HIGH STAND OFF TYPE

CAT. NO. PHEC...R-S21-H

DRAWING NO. JSC 90752 REV 5

BURNDY JAPAN, Ltd.

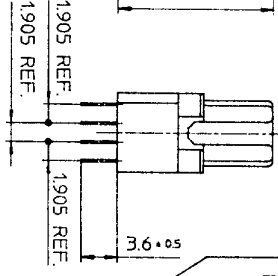
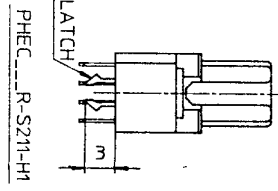
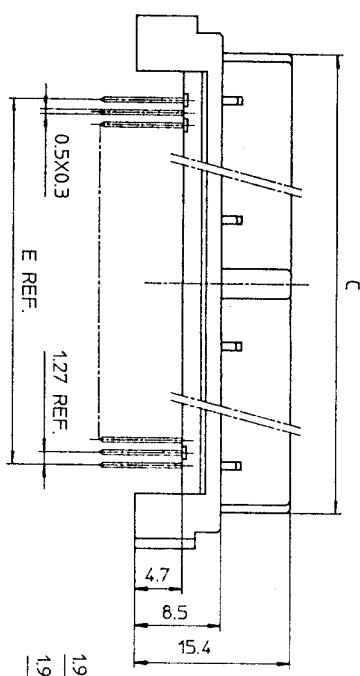
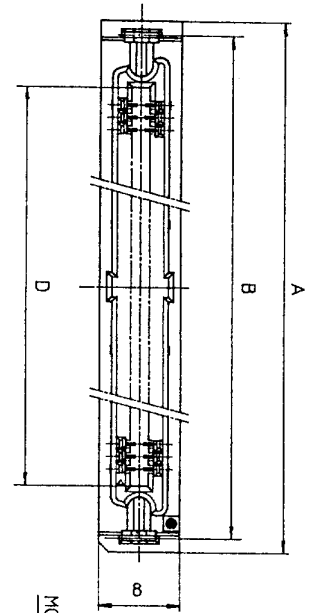

RECOMMENDED PC BOARD
THICKNESS: 1.6 ±0.2
HOLE PATTERN (COMPONENT SIDE)
NO. OF CONTACTS: 40,60,68

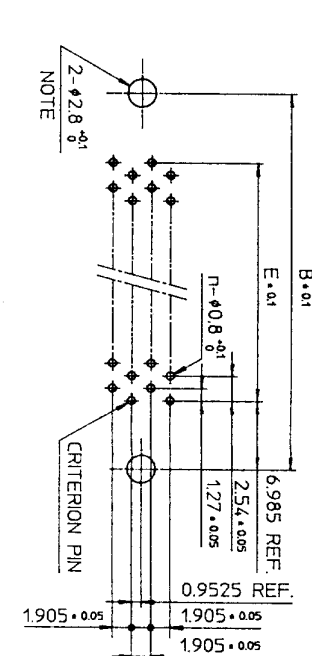

NOTE
THROUGH-HOLES FOR MOUNTING LATCHES ALSO SHOULD BE PLATED.
CRITERION PIN

NO. OF CONTACTS: 40,60,68

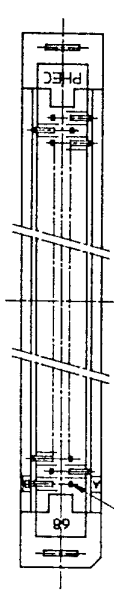

NO. OF CONTACTS: 30,34,50

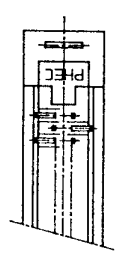

| CAT. NO. | NO. OF CONTACTS (MATING SIDE) | DIMENSIONS | | | | |
|----------------|-------------------------------|------------|-------|-------|-------|-------|
| | | A | B | C | D | E |
| PHEC30R-S21-H1 | 15/ROW X 2 ROWS | 34.55 | 31.75 | 27.26 | 21.26 | 17.78 |
| PHEC34R-S21-H1 | 17/ROW X 2 ROWS | 37.09 | 34.29 | 29.8 | 23.8 | 20.32 |
| PHEC40R-S21-H1 | 20/ROW X 2 ROWS | 40.9 | 38.1 | 33.61 | 27.61 | 24.13 |
| PHEC50R-S21-H1 | 25/ROW X 2 ROWS | 47.25 | 44.45 | 39.96 | 33.96 | 30.48 |
| PHEC60R-S21-H1 | 30/ROW X 2 ROWS | 53.6 | 50.8 | 46.31 | 40.31 | 36.83 |
| PHEC68R-S21-H1 | 34/ROW X 2 ROWS | 58.68 | 55.88 | 51.39 | 45.39 | 41.91 |

TOLERANCES
UNLESS OTHERWISE SPECIFIED: ±0.3

MATERIAL

INSULATOR: PBT RESIN GLASS REINFORCED (UL94V-0)
COLOR: BLACK

CONTACT: PHOSPHOR BRONZE
MOUNTING LATCH: PHOSPHOR BRONZE
SOLDER PLATED

CONTACT PLATING TABLE
(THICKNESS: μm)

| CONTACT AREA | REMAINDER |
|-----------------------------------|-----------------------|
| GOLD 0.25 MIN. OVER NICKEL 3.2 | SOLDER OVER NICKEL |

DRAWING NO. JSC 91840

PRINTED CIRCUIT CONNECTOR
HIGH STAND OFF TYPE
CAT. NO. PHEC_R-S21-H1
DRAWING NO. JSC 91840
REV. 1
BURNDY JAPAN, Ltd.

DESIGNED
DRAWN M. Oba
CHECKED A. Matsuo
APPROVED S. Ito
DATE Aug. 17, 1992

SCALE
DIM IN mm
MATERIAL

| REV | DATE | DESCRIPTION | CKD |
|-----|------|-------------------------------|-----|
| 1 | 93 | WRONG CONTACT DIM. CORRECTED. | |
| 2 | 91 | | |

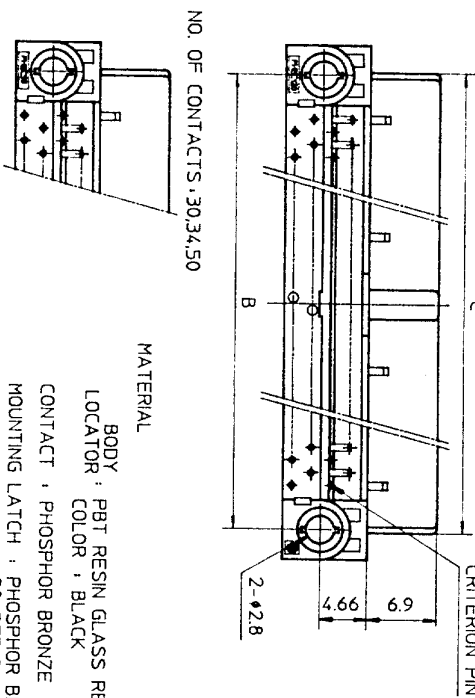
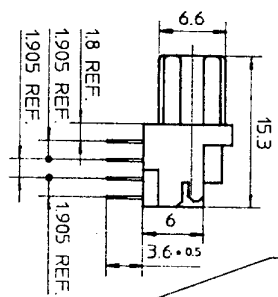
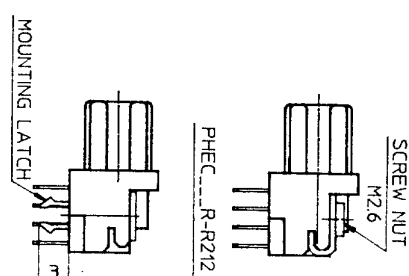
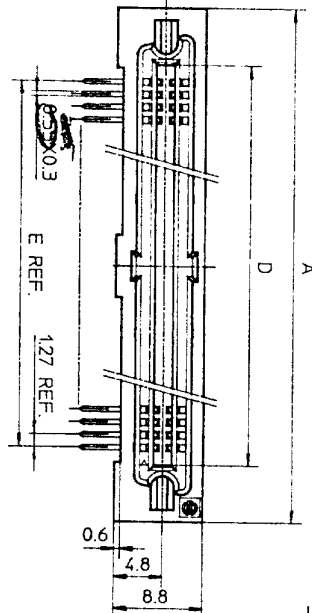
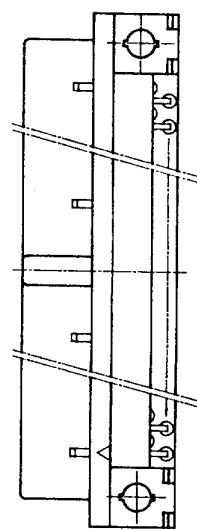

| CAT. NO. | NO. OF CONTACTS (MATING SIDE) | DIMENSIONS | | | | |
|--------------|-------------------------------|------------|-------|-------|-------|-------|
| | | A | B | C | D | E |
| PHEC30R-R21 | 15/ROW X 2 ROWS | 32.67 | 26.67 | 27.26 | 21.26 | 17.78 |
| PHEC34R-R21 | 17/ROW X 2 ROWS | 35.21 | 29.21 | 29.8 | 23.8 | 20.32 |
| PHEC40R-R21 | 20/ROW X 2 ROWS | 39.02 | 33.02 | 33.61 | 27.61 | 24.13 |
| PHEC50R-R21 | 25/ROW X 2 ROWS | 45.37 | 39.37 | 39.96 | 33.96 | 30.48 |
| PHEC60R-R21 | 30/ROW X 2 ROWS | 51.72 | 45.72 | 46.31 | 40.31 | 36.83 |
| PHEC68R-R21 | 34/ROW X 2 ROWS | 56.8 | 50.8 | 51.39 | 45.39 | 41.91 |
| PHEC80R-R21 | 40/ROW X 2 ROWS | 64.42 | 58.42 | 59.01 | 53.01 | 49.53 |
| PHEC100R-R21 | 50/ROW X 2 ROWS | 77.12 | 71.12 | 71.71 | 65.71 | 62.23 |
| PHEC120R-R21 | 60/ROW X 2 ROWS | 89.82 | 83.82 | 84.41 | 78.41 | 74.93 |

CONTACT PLATING TABLE
(THICKNESS: μm)

| CONTACT AREA | REMAINDER |
|-----------------|-------------|
| GOLD 0.25 MIN. | SOLDER |
| OVER NICKEL 3.2 | OVER NICKEL |

DRAWING NO. JSC 90738

NO. OF CONTACTS: 30,34,50
MATERIAL
BODY: PBT RESIN GLASS REINFORCED (UL94V-0)
LOCATOR COLOR: BLACK
CONTACT: PHOSPHOR BRONZE
MOUNTING LATCH: PHOSPHOR BRONZE
SCREW NUT: STEEL
NICKEL PLATED

RECOMMENDED PC BOARD
THICKNESS: 1.6 ±0.2
HOLE PATTERN (COMPONENT SIDE)
NO. OF CONTACTS: 40,60,68,80,
100,120

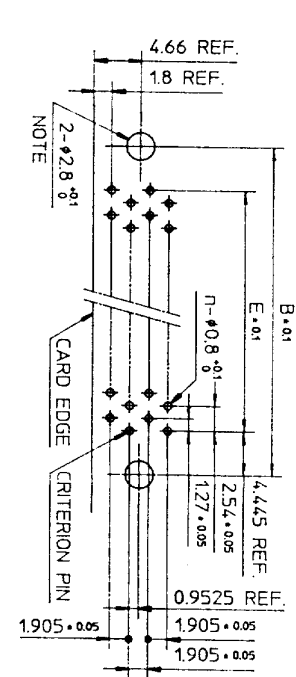

NOTE
THROUGH-HOLES FOR MOUNTING LATCHES ALSO SHOULD BE PLATED.
CRITERION PIN
TOLERANCES UNLESS OTHERWISE SPECIFIED: ±0.3

| | | | | | |
|-----------|------------------------------|-----|------------|-------------------|---------------------------|
| REV. DATE | DESCRIPTION | CKD | SCALE | DESIGNED | PRINTED CIRCUIT CONNECTOR |
| 3 | 30,34,50,68 POSITIONS ADDED. | 1.2 | DIM. IN mm | M. Osa | CAT. NO. PHEC...R-R21 |
| 2 | EC 7866 | 2.0 | MATERIAL | CHECKED | DRAWING NO. JSC 90738 |
| 1 | EC 7837 | 2.0 | | APPROVED | REV. 3 |
| REFERENCE | | | | DATE Mar. 8, 1990 | BURNDY JAPAN, Ltd. |