

NO. OF CONTACTS : 40,60,68,80,100,120  
CRITERION PIN

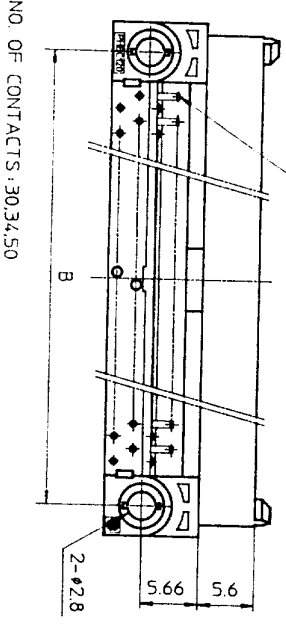

NO. OF CONTACTS : 30,34,50

MATERIAL : NYLON RESIN GLASS REINFORCED (UL94V-0)  
BODY : BLACK  
LOCATOR : PBT RESIN GLASS REINFORCED (UL94V-0)  
COLOR : BLACK

CONTACT : COPPER ALLOY  
MOUNTING LATCH : PHOSPHOR BRONZE  
SCREW NUT : STEEL  
NICKEL PLATED

CAT. NO.	NO. OF CONTACTS (MATING SIDE)	DIMENSIONS				
		A	B	C	D	E
PHEC30P-R21	15/ROW X 2 ROWS	32.67	26.67	30.3	20.42	17.78
PHEC34P-R21	17/ROW X 2 ROWS	35.21	29.21	32.84	22.96	20.32
PHEC40P-R21	20/ROW X 2 ROWS	39.02	33.02	36.65	26.77	24.13
PHEC50P-R21	25/ROW X 2 ROWS	45.37	39.37	43	33.12	30.48
PHEC60P-R21	30/ROW X 2 ROWS	51.72	45.72	49.35	39.47	36.83
PHEC68P-R21	34/ROW X 2 ROWS	56.8	50.8	54.43	44.55	41.91
PHEC80P-R21	40/ROW X 2 ROWS	64.42	58.42	62.05	52.17	49.53
PHEC100P-R21	50/ROW X 2 ROWS	77.12	71.12	74.75	64.87	62.23
PHEC120P-R21	60/ROW X 2 ROWS	89.82	83.82	87.45	77.57	74.93

TOLERANCES UNLESS OTHERWISE SPECIFIED : ±0.3

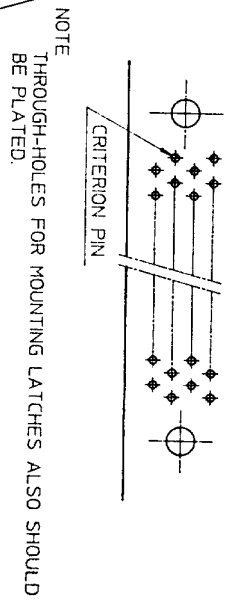

NOTE THROUGH-HOLES FOR MOUNTING LATCHES ALSO SHOULD BE PLATED.

CONTACT PLATING TABLE [THICKNESS : μm]

CONTACT AREA	REMAINDER
GOLD 0.25 MIN. OVER NICKEL 3Z	SOLDER OVER NICKEL

DRAWING NO. JSC 90736

92 8-14 90 6-7 90 4-20 REV DATE DESCRIPTION CKD		30,34,50,68 POSITIONS ADDED. LOCATOR MATERIAL ADDED. EC 7866 EC 7837	SCALE DIM. IN MATERIAL	DESIGNED DRAWN <i>M. Oba</i> CHECKED <i>4.8/</i> APPROVED <i>J. Ogasawara</i> DATE Mar. 8, 1990	PRINTED CIRCUIT CONNECTOR CAT. NO. PHEC__P-R21_ DRAWING NO. JSC 90736 REV 3
REFERENCE					

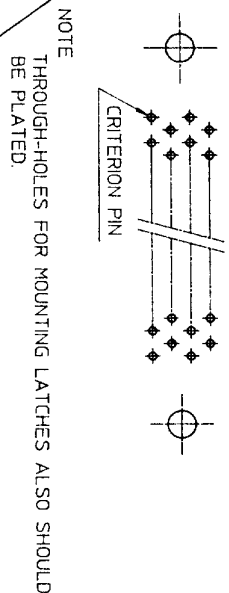
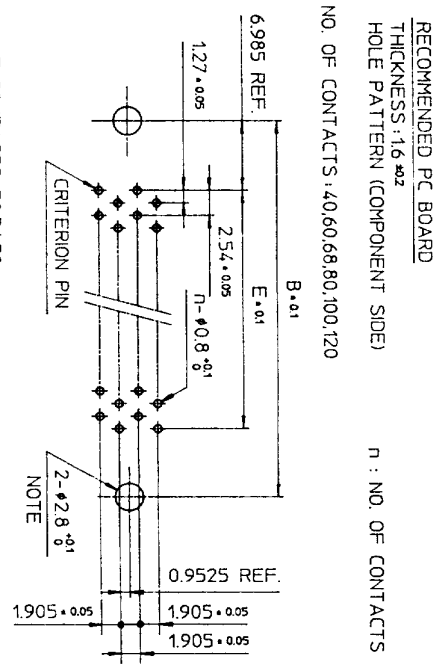
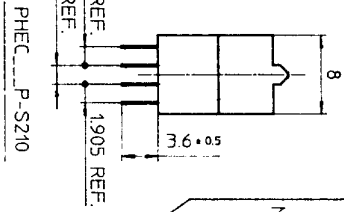
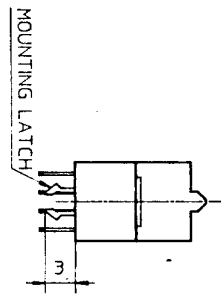
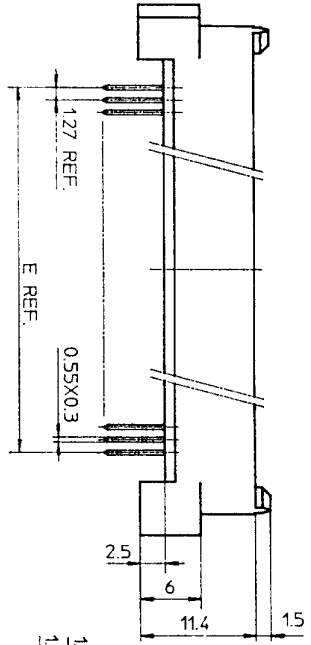
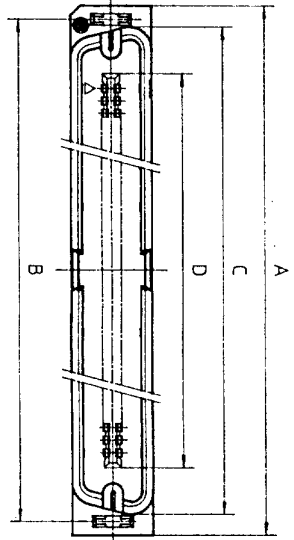

NO. OF CONTACTS : 40,60,68,80,100,120

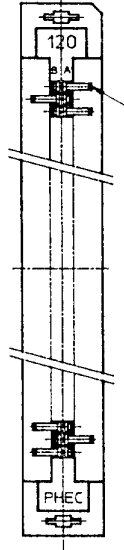

NO. OF CONTACTS : 30,34,50

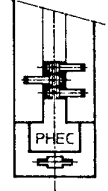

MATERIAL

INSULATOR : NYLON RESIN GLASS REINFORCED (UL94V-0)  
 COLOR : BLACK  
 CONTACT : COPPER ALLOY  
 MOUNTING LATCH : PHOSPHOR BRONZE  
 SOLDER PLATED

CAT. NO.	NO. OF CONTACTS (MATING SIDE)	DIMENSIONS				
		A	B	C	D	E
PHEC30P-S21L	15/ROW X 2 ROWS	34.55	31.75	30.3	20.42	17.78
PHEC34P-S21L	17/ROW X 2 ROWS	37.09	34.29	32.84	22.96	20.32
PHEC40P-S21L	20/ROW X 2 ROWS	40.9	38.1	36.65	26.77	24.13
PHEC50P-S21L	25/ROW X 2 ROWS	47.25	44.45	4.3	33.12	30.48
PHEC60P-S21L	30/ROW X 2 ROWS	53.6	50.8	49.35	39.47	36.83
PHEC68P-S21L	34/ROW X 2 ROWS	58.68	55.88	54.43	44.55	41.91
PHEC80P-S21L	40/ROW X 2 ROWS	66.3	63.5	62.05	52.17	49.53
PHEC100P-S21L	50/ROW X 2 ROWS	79.0	76.2	74.75	64.87	62.23
PHEC120P-S21L	60/ROW X 2 ROWS	91.7	88.9	87.45	77.57	74.93

CONTACT PLATING TABLE

CONTACT AREA	REMAINDER
GOLD 0.25 MIN	SOLDER
OVER NICKEL 3.2	OVER NICKEL

DRAWING NO JSC 90735

PRINTED CIRCUIT CONNECTOR  
 CAT. NO. PHEC\_P-S21L  
 DRAWING NO. JSC 90735  
 REV. 3  
**BURNDY JAPAN, Ltd.**

DESIGNED  
 DRAWN *M. Oba*  
 CHECKED *A. Eb*  
 APPROVED *J. Nakagishi*  
 DATE Mar. 8, 1990

SCALE  
 DIM. IN mm  
 MATERIAL

REV.	DATE	DESCRIPTION	CHKD.
3	'92-8-11	30,34,50,68 POSITIONS ADDED.	<i>JK</i>
2	'90-6-5	EC 7866	<i>JK</i>
1	'90-4-20	EC 7837	<i>JK</i>

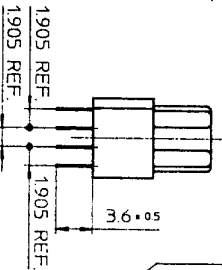
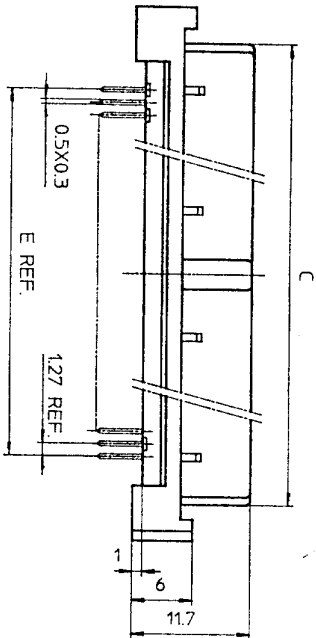
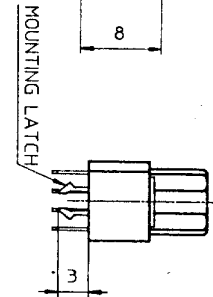
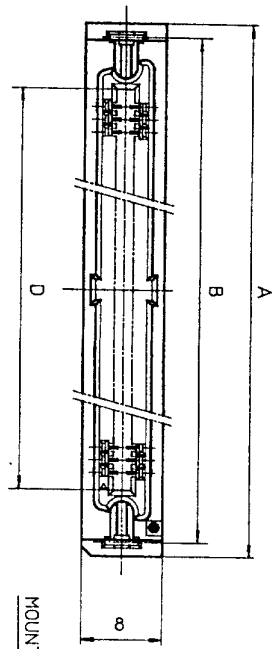

PHEC...R-S210

PHEC...R-S211

RECOMMENDED PC BOARD  
THICKNESS: 1.6 ± 0.2  
HOLE PATTERN (COMPONENT SIDE)  
NO. OF CONTACTS: 40, 60, 68, 80, 100, 120  
n : NO. OF CONTACTS

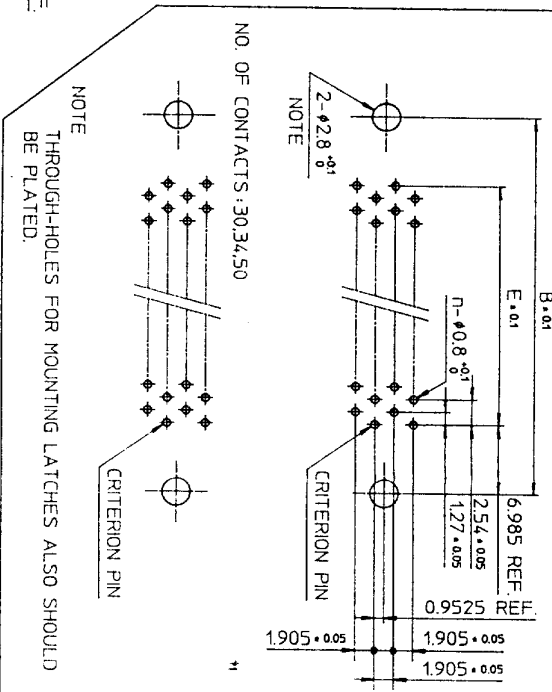

TOLERANCES  
UNLESS OTHERWISE SPECIFIED: ±0.3

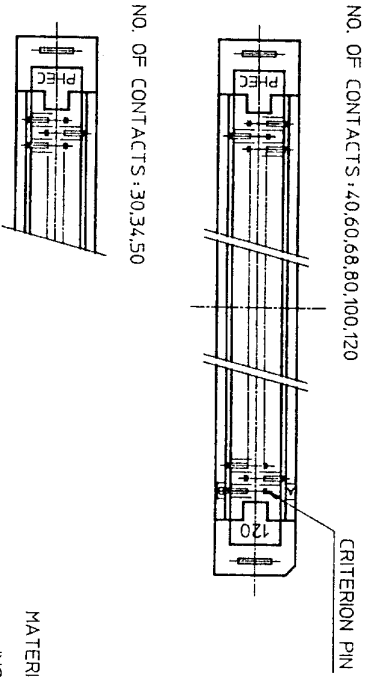

CAT. NO.	NO. OF CONTACTS (MATING SIDE)	DIMENSIONS				
		A	B	C	D	E
PHEC30R-S21	15/ROW X 2 ROWS	34.55	31.75	27.26	21.26	17.78
PHEC34R-S21	17/ROW X 2 ROWS	37.09	34.29	29.8	23.8	20.32
PHEC40R-S21	20/ROW X 2 ROWS	40.9	38.1	33.61	27.61	24.13
PHEC50R-S21	25/ROW X 2 ROWS	47.25	44.45	39.96	33.96	30.48
PHEC60R-S21	30/ROW X 2 ROWS	53.6	50.8	46.31	40.31	36.83
PHEC68R-S21	34/ROW X 2 ROWS	58.68	55.88	51.39	45.39	41.91
PHEC80R-S21	40/ROW X 2 ROWS	66.3	63.5	59.01	53.01	49.53
PHEC100R-S21	50/ROW X 2 ROWS	79.0	76.2	71.71	65.71	62.23
PHEC120R-S21	60/ROW X 2 ROWS	91.7	88.9	84.41	78.41	74.93

MATERIAL

INSULATOR: PBT RESIN GLASS REINFORCED (UL-94V-0)  
COLOR: BLACK

CONTACT: PHOSPHOR BRONZE  
MOUNTING LATCH: PHOSPHOR BRONZE  
SOLDER PLATED

CONTACT PLATING TABLE

CONTACT AREA	REMAINDER	SOLDER
GOLD 0.25 MIN. OVER NICKEL 3.2		OVER NICKEL

DRAWING NO. JSC 90737

PRINTED CIRCUIT CONNECTOR  
CAT. NO. PHEC...R-S21  
DRAWING NO. JSC 90737  
REV. 4  
**BURNDY JAPAN, Ltd.**

DESIGNED  
DRAWN *M. Oba*  
CHECKED *A. Ch*  
APPROVED *J. Nakagishi*  
DATE Mar. 8, 1990

SCALE  
DIM. IN. mm  
MATERIAL

REV. DATE	DESCRIPTION	CKD
4-1-29	WRONG CONTACT DIM. CORRECTED.	
3-8-11	30,34,50,68 POSITIONS ADDED No. 5.9	
2-5-30	EC 7866 No. JK	
1-4-20	EC 7837 No. JK	

DRAWING NO.  
JSC 90739

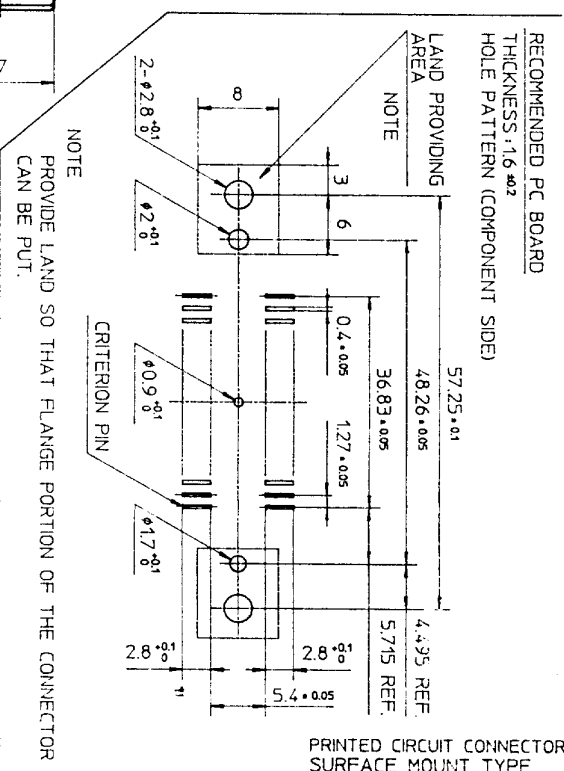
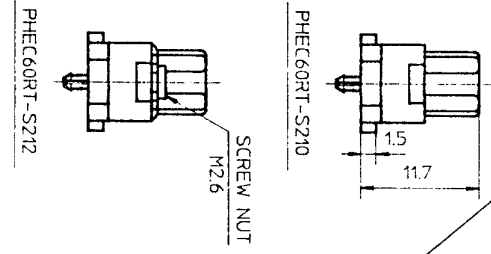
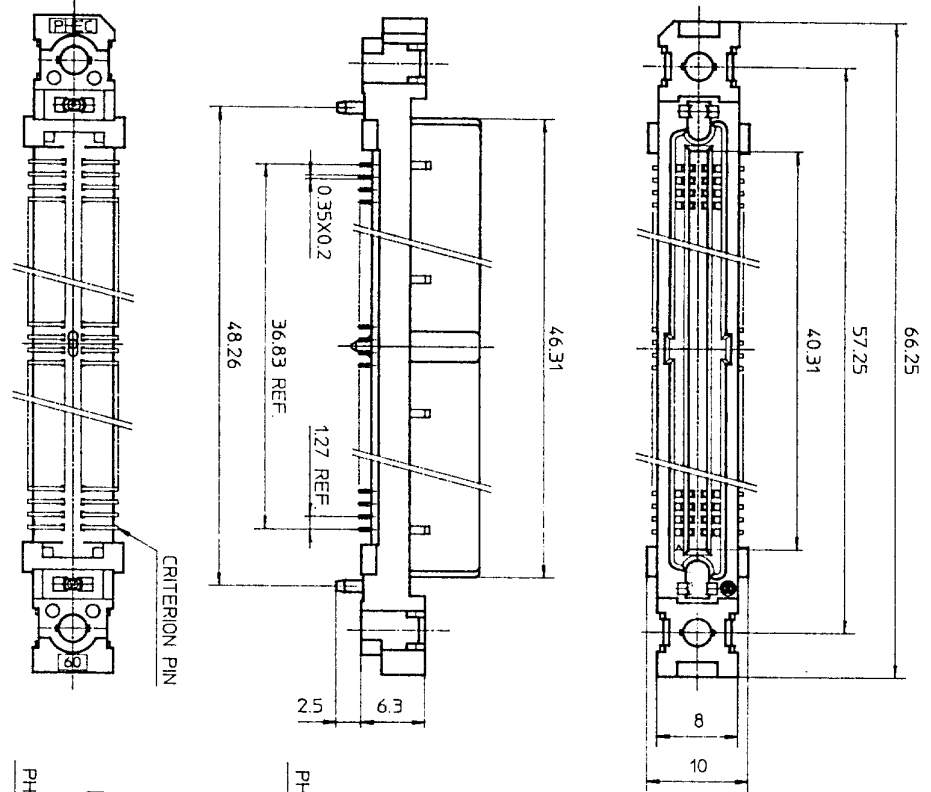

MATERIAL  
INSULATOR : PPS RESIN GLASS REINFORCED (UL94V-0)  
COLOR : BLACK  
CONTACT : PHOSPHOR BRONZE  
SCREW NUT : STAINLESS  
NO. OF CONTACTS : 30/ROW X 2 ROWS (MATING SIDE)

CONTACT PLATING TABLE  
(THICKNESS : μm)

CONTACT AREA	REMAINDER
GOLD 0.25 MIN.	SOLDER
OVER NICKEL 3Z	OVER NICKEL

TOLERANCES  
UNLESS OTHERWISE SPECIFIED : ±0.3

PRINTED CIRCUIT CONNECTOR  
SURFACE MOUNT TYPE

REV	DATE	DESCRIPTION	CHK.
4	'92 8-14	WRONG CONTACT DIM. CORRECTED 100 POSITIONS OF DELETED.	M. Oba
3	'92 1-8	DIM. CHANGED.	J. Kobayashi
2	'90 6-8	EC7866	J. Kobayashi
1	'90 4-20	VARIATION ADDED.	J. Kobayashi

SCALE	1:1
DIM IN	mm
MATERIAL	

DESIGNED	
DRAWN	M. Oba
CHECKED	J. Kobayashi
APPROVED	J. Kobayashi
DATE	Mar. 8, 1990

CAT. NO.	PHEC60RT-S212
DRAWING NO.	JSC 90739
REV	4

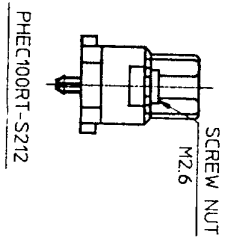
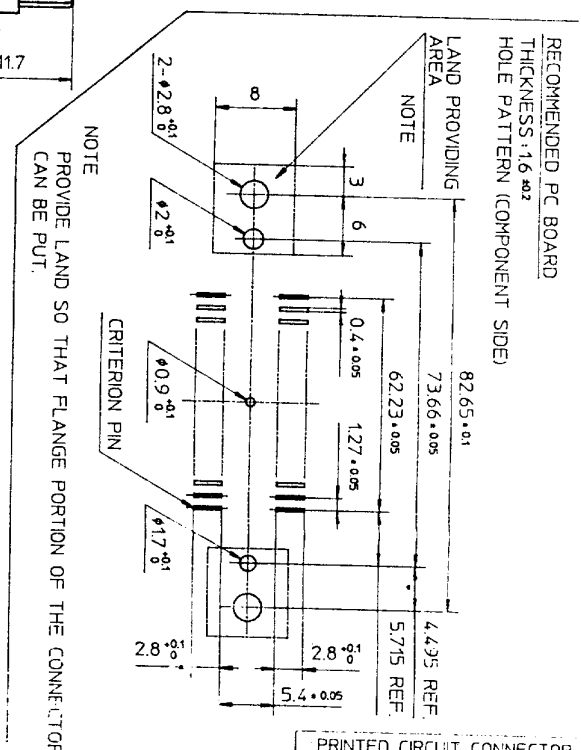
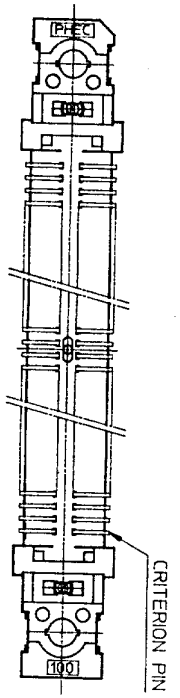
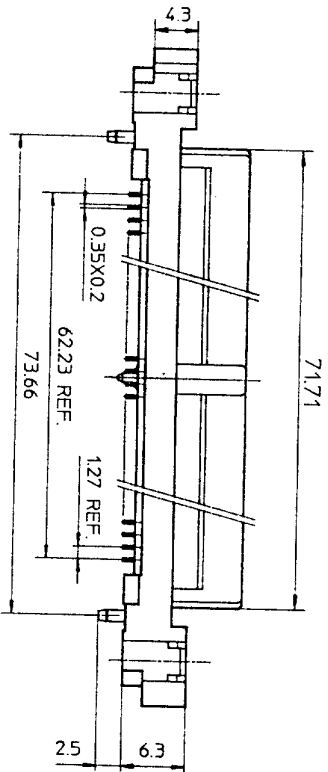
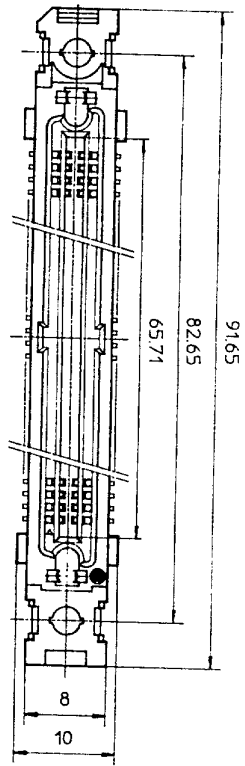

TOLERANCES  
UNLESS OTHERWISE SPECIFIED: ±0.3

MATERIAL  
INSULATOR: PPS RESIN GLASS REINFORCED (UL94V-0)  
COLOR: BLACK  
CONTACT: PHOSPHOR BRONZE  
SCREW NUT: STAINLESS  
NO. OF CONTACTS: 50/ROW X 2 ROWS (MATING SIDE)

CONTACT PLATING TABLE

CONTACT AREA	REMAINDER
GOLD 0.25 MIN OVER NICKEL 3.2	SOLDER OVER NICKEL

(THICKNESS: μm)

PRINTED CIRCUIT CONNECTOR  
SURFACE MOUNT TYPE

CAT. NO. PHEC100RT-S21L

DRAWING NO. JSC 91839 REV. 0

**BURNDY**  
JAPAN, Ltd.

DESIGNED: [Signature]  
DRAWN: [Signature]  
CHECKED: A. [Signature]  
APPROVED: [Signature]  
DATE: Aug. 11, 1992

SCALE: 1/10  
DIM. IN: mm  
MATERIAL:

REV.	DATE	DESCRIPTION	CHKD.

REFERENCE:

DRAWING NO. JSC 91839

DRAWING NO. JSC 90752

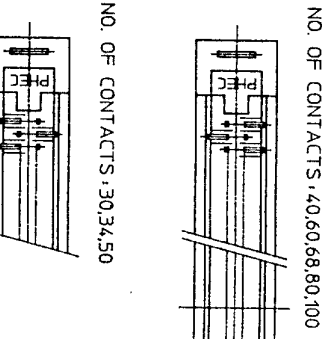
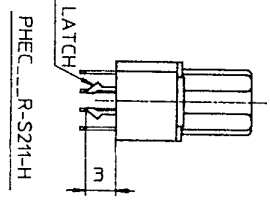
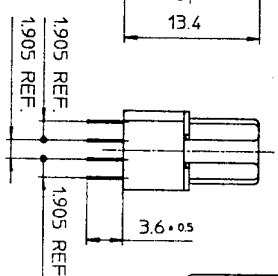
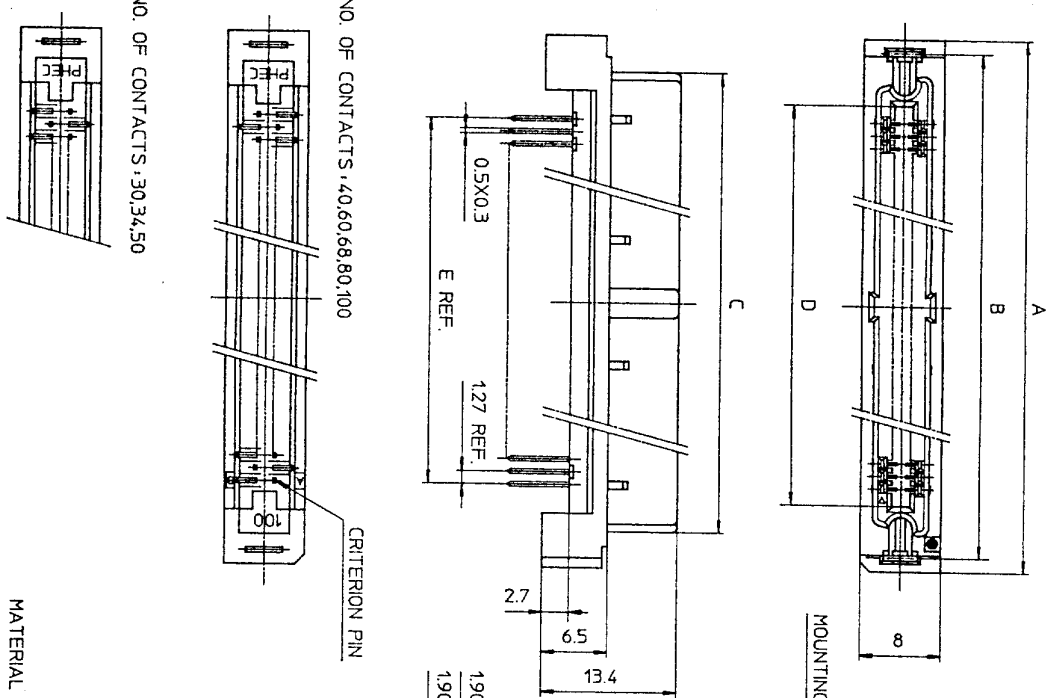

MATERIAL

INSULATOR: PBT RESIN GLASS REINFORCED (UL94V-0)  
COLOR: BLACK

CONTACT: PHOSPHOR BRONZE  
MOUNTING LATCH: PHOSPHOR BRONZE  
SOLDER PLATED

CAT. NO.	NO. OF CONTACTS (MATING SIDE)	DIMENSIONS				
		A	B	C	D	E
PHEC30R-S21-H	15/ROW X 2 ROWS	34.55	31.75	27.26	21.26	17.78
PHEC34R-S21-H	17/ROW X 2 ROWS	37.09	34.29	29.8	23.8	20.32
PHEC40R-S21-H	20/ROW X 2 ROWS	40.9	38.1	33.61	27.61	24.13
PHEC50R-S21-H	25/ROW X 2 ROWS	47.25	44.45	39.96	33.96	30.48
PHEC60R-S21-H	30/ROW X 2 ROWS	53.6	50.8	46.31	40.31	36.83
PHEC68R-S21-H	34/ROW X 2 ROWS	58.68	55.88	51.99	45.99	41.91
PHEC80R-S21-H	40/ROW X 2 ROWS	66.3	63.5	59.01	53.01	49.53
PHEC100R-S21-H	50/ROW X 2 ROWS	79.0	76.2	71.71	65.71	62.23

TOLERANCES UNLESS OTHERWISE SPECIFIED: ±0.3

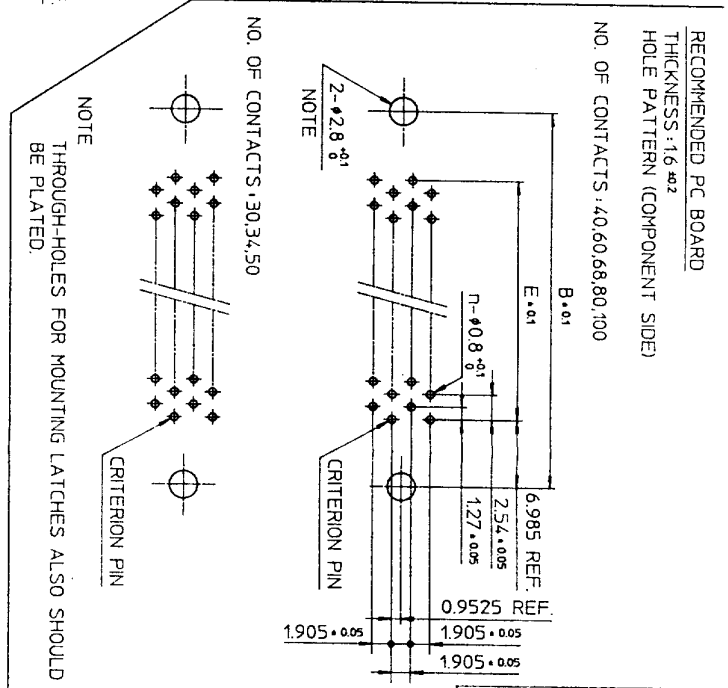

NOTE: THROUGH-HOLES FOR MOUNTING LATCHES ALSO SHOULD BE PLATED.

RECOMMENDED PC BOARD THICKNESS: 1.6 ±0.2

NO. OF CONTACTS: 40,60,68,80,100

CONTACT PLATING TABLE (THICKNESS: μm)

CONTACT AREA	REMAINDER
GOLD 0.25 MIN	SOLDER
OVER NICKEL 3.2	OVER NICKEL

REV	DATE	DESCRIPTION	CHKD.
5	93-6-22	100 POSITIONS ADDED.	M.O
4	93-2-1	WRONG CONTACT DIM. CORRECTED.	5.9
3	92-8-11	100,120 POSITIONS DELETED. 30,34,50,68 POSITIONS ADDED.	5.9
2	90-5-30	DIM. CHANGED (36.61 → 33.61)	5.9
1	90-5-14	EC 7866	HE

SCALE: 1:1  
DIM. IN: mm

DESIGNED: M. Oga  
DRAWN: M. Oga  
CHECKED: A. Oga  
APPROVED: J. Oga  
DATE: Mar. 24, 1990

PRINTED CIRCUIT CONNECTOR HIGH STAND OFF TYPE

CAT. NO. PHEC...R-S21-H

DRAWING NO. JSC 90752 REV. 5

**BURNDY JAPAN, Ltd.**

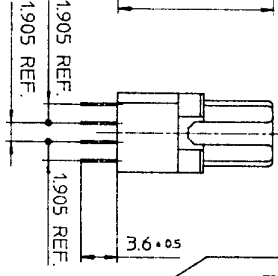
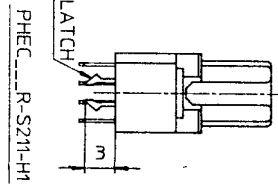
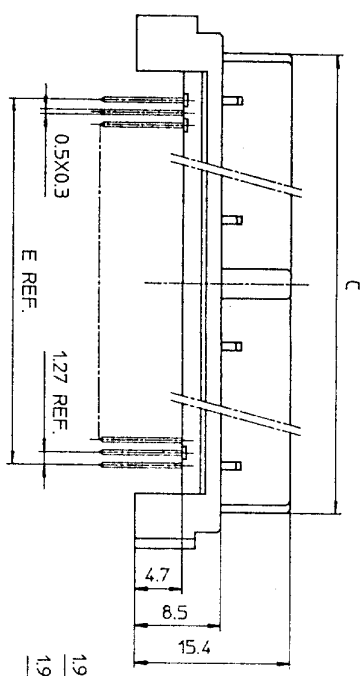
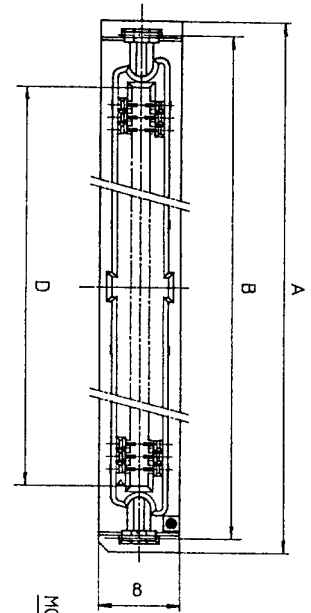

RECOMMENDED PC BOARD  
THICKNESS: 1.6 ±0.2  
HOLE PATTERN (COMPONENT SIDE)  
NO. OF CONTACTS: 40,60,68

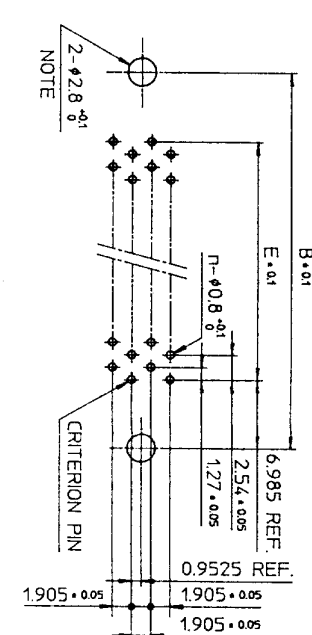

NOTE  
THROUGH-HOLES FOR MOUNTING LATCHES ALSO SHOULD BE PLATED.  
CRITERION PIN

NO. OF CONTACTS: 40,60,68

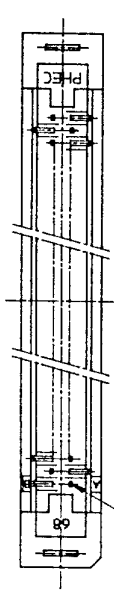

NO. OF CONTACTS: 30,34,50

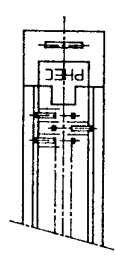

CAT. NO.	NO. OF CONTACTS (MATING SIDE)	DIMENSIONS				
		A	B	C	D	E
PHEC30R-S21-H1	15/ROW X 2 ROWS	34.55	31.75	27.26	21.26	17.78
PHEC34R-S21-H1	17/ROW X 2 ROWS	37.09	34.29	29.8	23.8	20.32
PHEC40R-S21-H1	20/ROW X 2 ROWS	40.9	38.1	33.61	27.61	24.13
PHEC50R-S21-H1	25/ROW X 2 ROWS	47.25	44.45	39.96	33.96	30.48
PHEC60R-S21-H1	30/ROW X 2 ROWS	53.6	50.8	46.31	40.31	36.83
PHEC68R-S21-H1	34/ROW X 2 ROWS	58.68	55.88	51.39	45.39	41.91

TOLERANCES  
UNLESS OTHERWISE SPECIFIED: ±0.3

MATERIAL

INSULATOR: PBT RESIN GLASS REINFORCED (UL94V-0)  
COLOR: BLACK

CONTACT: PHOSPHOR BRONZE  
MOUNTING LATCH: PHOSPHOR BRONZE  
SOLDER PLATED

CONTACT PLATING TABLE  
(THICKNESS: μm)

CONTACT AREA	REMAINDER
GOLD 0.25 MIN. OVER NICKEL 3.2	SOLDER OVER NICKEL

DRAWING NO. JSC 91840

PRINTED CIRCUIT CONNECTOR  
HIGH STAND OFF TYPE  
CAT. NO. PHEC...R-S21-H1  
DRAWING NO. JSC 91840  
REV. 1  
**BURNDY JAPAN, Ltd.**

DESIGNED  
DRAWN *M. Oba*  
CHECKED A. Matsuo  
APPROVED *S. Ito*  
DATE Aug. 17, 1992

SCALE  
DIM IN mm  
MATERIAL

REV	DATE	DESCRIPTION	CKD
1	93	WRONG CONTACT DIM. CORRECTED.	
2	93		

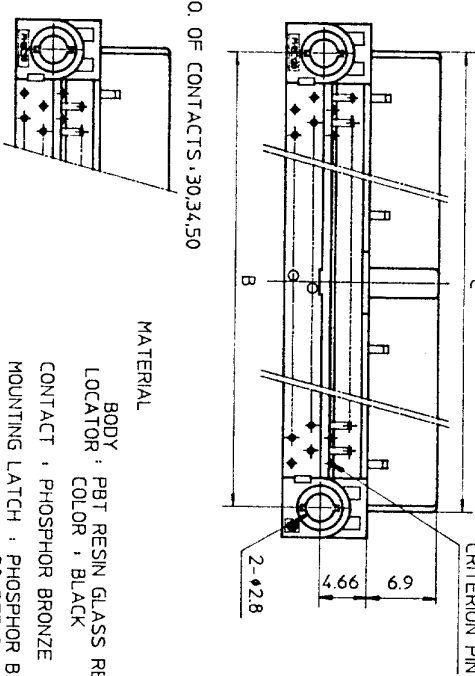
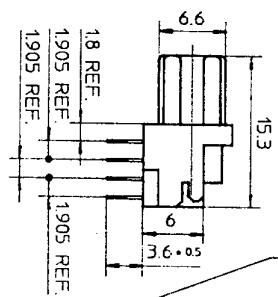
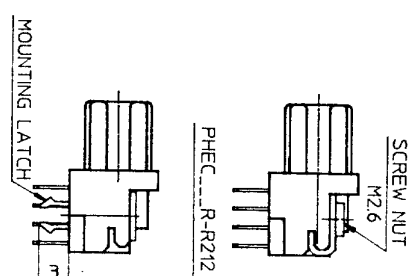
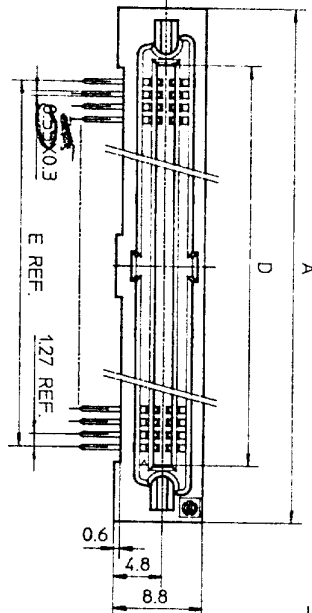
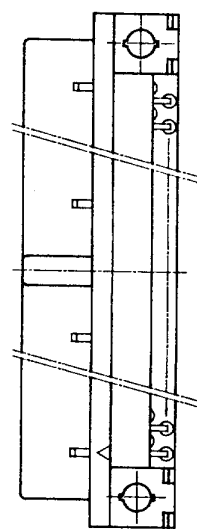

NO. OF CONTACTS : 30,34,50

NO. OF CONTACTS : 40,60,68,80,100,120

CAT. NO.	NO. OF CONTACTS (MATING SIDE)	DIMENSIONS				
		A	B	C	D	E
PHEC30R-R21	15/ROW X 2 ROWS	32.67	26.67	27.26	21.26	17.78
PHEC34R-R21	17/ROW X 2 ROWS	35.21	29.21	29.8	23.8	20.32
PHEC40R-R21	20/ROW X 2 ROWS	39.02	33.02	33.61	27.61	24.13
PHEC50R-R21	25/ROW X 2 ROWS	45.37	39.37	39.96	33.96	30.48
PHEC60R-R21	30/ROW X 2 ROWS	51.72	45.72	46.31	40.31	36.83
PHEC68R-R21	34/ROW X 2 ROWS	56.8	50.8	51.39	45.39	41.91
PHEC80R-R21	40/ROW X 2 ROWS	64.42	58.42	59.01	53.01	49.53
PHEC100R-R21	50/ROW X 2 ROWS	77.12	71.12	71.71	65.71	62.23
PHEC120R-R21	60/ROW X 2 ROWS	89.82	83.82	84.41	78.41	74.93

MATERIAL  
 BODY : PBT RESIN GLASS REINFORCED (UL94V-0)  
 LOCATOR COLOR : BLACK  
 CONTACT : PHOSPHOR BRONZE  
 MOUNTING LATCH : PHOSPHOR BRONZE  
 SCREW NUT : STEEL  
 NICKEL PLATED

CONTACT PLATING TABLE  
 (THICKNESS : μm)

CONTACT AREA	REMAINDER
GOLD 0.25 MIN.	SOLDER
OVER NICKEL 3.2	OVER NICKEL

RECOMMENDED PC BOARD  
 THICKNESS : 1.6 ±0.2  
 HOLE PATTERN (COMPONENT SIDE)  
 NO. OF CONTACTS : 40,60,68,80,  
 100,120

n : NO. OF CONTACTS

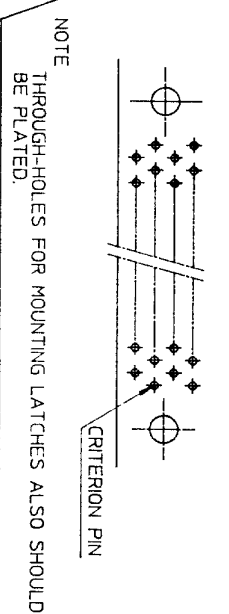
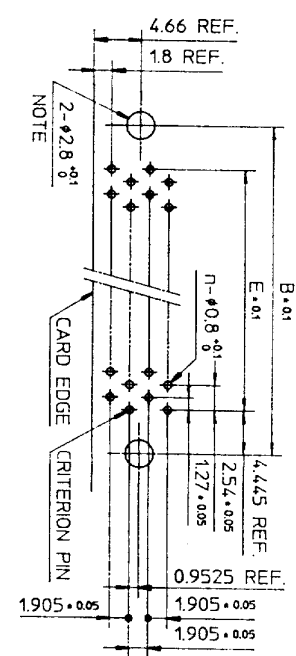

TOLERANCES  
 UNLESS OTHERWISE SPECIFIED : ±0.3

DRAWING NO  
 JSC 90738

REV. DATE	DESCRIPTION	CKD	SCALE	DESIGNED	PRINTED CIRCUIT CONNECTOR
3	8-11 30,34,50,68 POSITIONS ADDED.	1.2	DIM. IN mm	M. Osa	CAT. NO. PHEC...R-R21
2	6-8 EC 7866	2.0	MATERIAL	CHECKED 4. Ely	DRAWING NO. JSC 90738
1	4-20 EC 7837	2.0		APPROVED J. Yamashita	3
REFERENCE				DATE Mar. 8, 1990	BURNDY JAPAN, Ltd.