

NO. OF CONTACTS : 40,60,68,80,100,120
CRITERION PIN

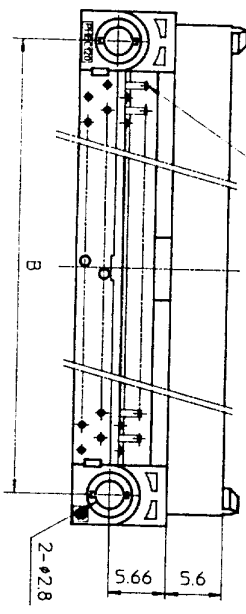

NO. OF CONTACTS : 30,34,50

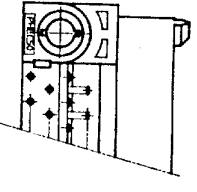

DRAWING NO.
JSC 90736

RECOMMENDED PC BOARD
THICKNESS : 1.6 ± 0.2
HOLE PATTERN (COMPONENT SIDE)

NO. OF CONTACTS : 40,60,68,80,100,120

n : NO. OF CONTACTS

TOLERANCES UNLESS OTHERWISE SPECIFIED : ±0.3

CAT. NO.	NO. OF CONTACTS (MATING SIDE)	DIMENSIONS				
		A	B	C	D	E
PHEC30P-R21	15/ROW X 2 ROWS	32.67	26.67	30.3	20.42	17.78
PHEC34P-R21	17/ROW X 2 ROWS	35.21	29.21	32.84	22.96	20.32
PHEC40P-R21	20/ROW X 2 ROWS	39.02	33.02	36.65	26.77	24.13
PHEC50P-R21	25/ROW X 2 ROWS	45.37	39.37	43	33.12	30.48
PHEC60P-R21	30/ROW X 2 ROWS	51.72	45.72	49.35	39.47	36.83
PHEC68P-R21	34/ROW X 2 ROWS	56.8	50.8	54.43	44.55	41.91
PHEC80P-R21	40/ROW X 2 ROWS	64.42	58.42	62.05	52.17	49.53
PHEC100P-R21	50/ROW X 2 ROWS	77.12	71.12	74.75	64.87	62.23
PHEC120P-R21	60/ROW X 2 ROWS	89.82	83.82	87.45	77.57	74.93

MATERIAL : NYLON RESIN GLASS REINFORCED (UL94V-0)
BODY : BLACK
LOCATOR : PBT RESIN GLASS REINFORCED (UL94V-0)
COLOR : BLACK

CONTACT : COPPER ALLOY
MOUNTING LATCH : PHOSPHOR BRONZE
SCREW NUT : STEEL
SCREW NUT : NICKEL PLATED

CONTACT PLATING TABLE (THICKNESS : μm)

CONTACT AREA	REMAINDER
GOLD 0.25 MIN. OVER NICKEL 3Z	SOLDER OVER NICKEL

REV	DATE	DESCRIPTION	CKD	SCALE	DIM. IN	MATERIAL	DESIGNED	DRAWN	CHECKED	APPROVED	DATE	PRINTED CIRCUIT CONNECTOR	CAT. NO.	DRAWING NO.	REV
92	8-14	30,34,50,68 POSITIONS ADDED. LOCATOR MATERIAL ADDED.											PHEC_P-R21	JSC 90736	3
2	6-7	EC 7866													
1	4-20	EC 7837													
REFERENCE															

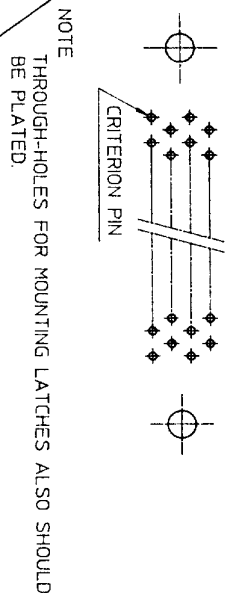
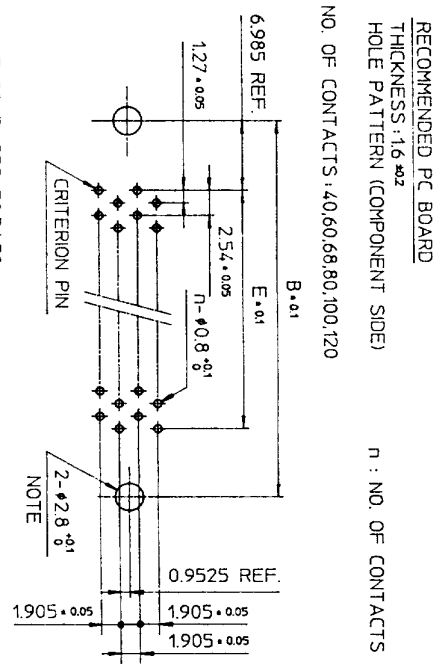
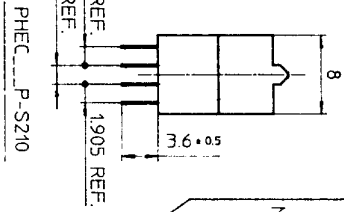
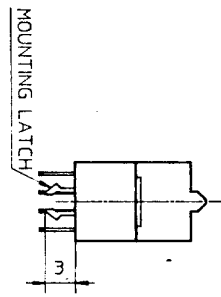
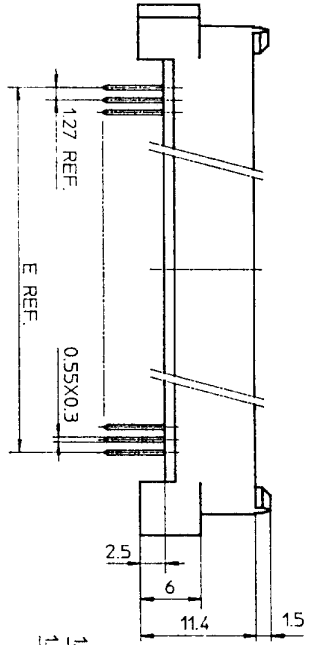
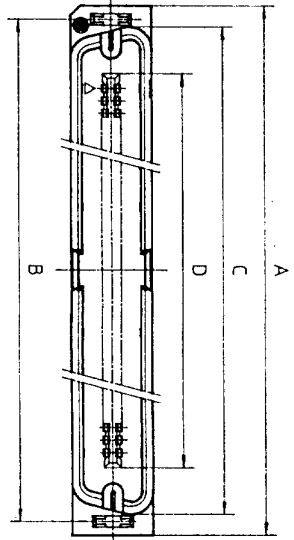

NO. OF CONTACTS : 40,60,68,80,100,120

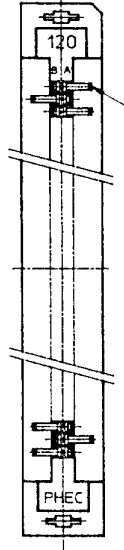

NO. OF CONTACTS : 30,34,50

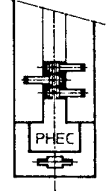

MATERIAL

INSULATOR : NYLON RESIN GLASS REINFORCED (UL94V-0)
 COLOR : BLACK
 CONTACT : COPPER ALLOY
 MOUNTING LATCH : PHOSPHOR BRONZE
 SOLDER PLATED

CAT. NO.	NO. OF CONTACTS (MATING SIDE)	DIMENSIONS				
		A	B	C	D	E
PHEC30P-S21L	15/ROW X 2 ROWS	34.55	31.75	30.3	20.42	17.78
PHEC34P-S21L	17/ROW X 2 ROWS	37.09	34.29	32.84	22.96	20.32
PHEC40P-S21L	20/ROW X 2 ROWS	40.9	38.1	36.65	26.77	24.13
PHEC50P-S21L	25/ROW X 2 ROWS	47.25	44.45	43	33.12	30.48
PHEC60P-S21L	30/ROW X 2 ROWS	53.6	50.8	49.35	39.47	36.83
PHEC68P-S21L	34/ROW X 2 ROWS	58.68	55.88	54.43	44.55	41.91
PHEC80P-S21L	40/ROW X 2 ROWS	66.3	63.5	62.05	52.17	49.53
PHEC100P-S21L	50/ROW X 2 ROWS	79.0	76.2	74.75	64.87	62.23
PHEC120P-S21L	60/ROW X 2 ROWS	91.7	88.9	87.45	77.57	74.93

CONTACT PLATING TABLE

CONTACT AREA	REMAINDER
GOLD 0.25 MIN	SOLDER
OVER NICKEL 3.2	OVER NICKEL

PRINTED CIRCUIT CONNECTOR
 CAT. NO. PHEC_P-S21L
 DRAWING NO. JSC 90735
 BURNDY JAPAN, Ltd.

DESIGNED
 DRAWN M. Oba
 CHECKED A. Eb
 APPROVED J. Nagasawa
 DATE Mar. 8, 1990

SCALE
 DIM. IN mm
 MATERIAL

REV.	DATE	DESCRIPTION	CHKD.
3	'92-8-11	30,34,50,68 POSITIONS ADDED.	JK
2	'90-6-5	EC 7866	JK
1	'90-4-20	EC 7837	JK

DRAWING NO. JSC 90735

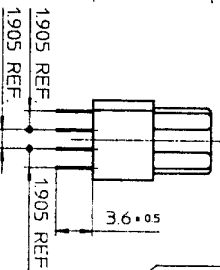
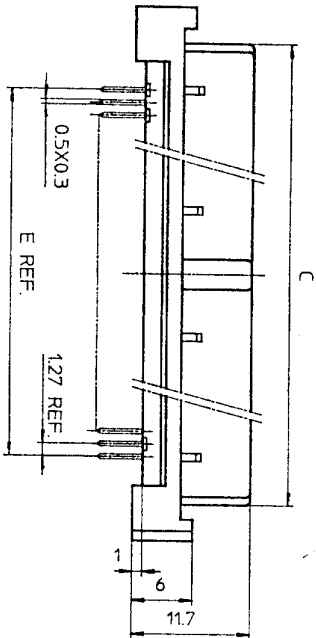
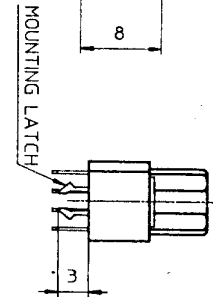
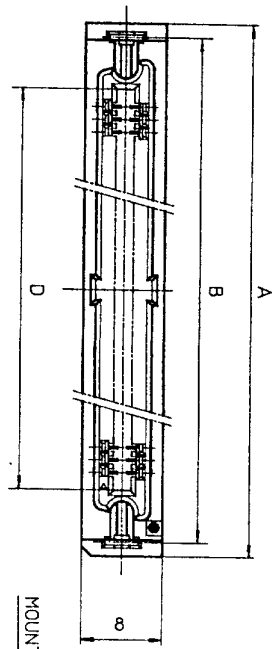

RECOMMENDED PC BOARD
 THICKNESS: 1.6 ± 0.2
 HOLE PATTERN (COMPONENT SIDE)
 NO. OF CONTACTS: 40, 60, 68, 80, 100, 120
 n : NO. OF CONTACTS

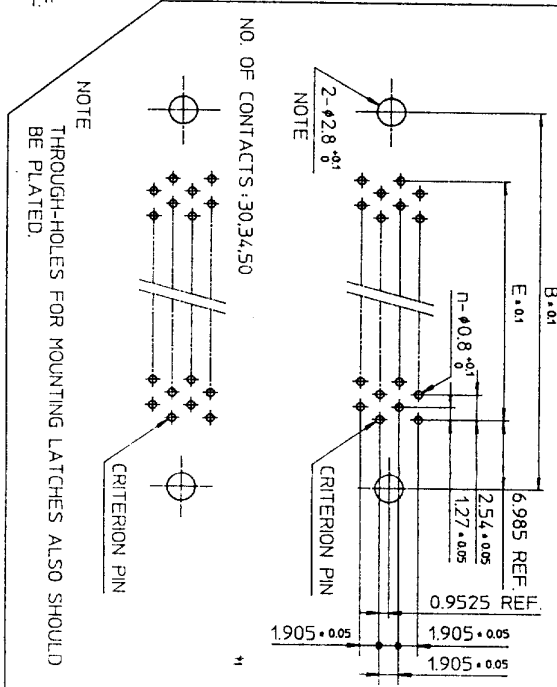

TOLERANCES
 UNLESS OTHERWISE SPECIFIED: ±0.3

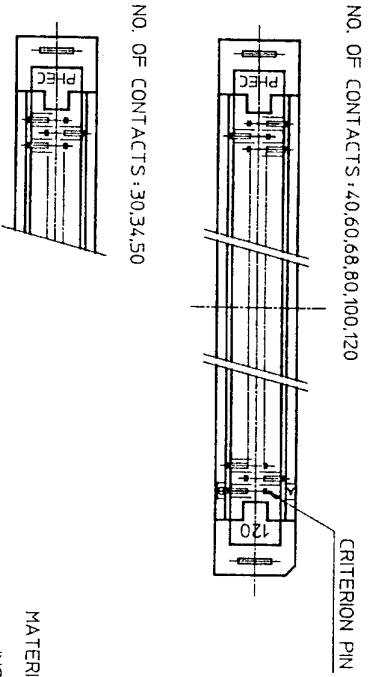

CAT. NO.	NO. OF CONTACTS (MATING SIDE)	DIMENSIONS				
		A	B	C	D	E
PHEC30R-S21	15/ROW X 2 ROWS	34.55	31.75	27.26	21.26	17.78
PHEC34R-S21	17/ROW X 2 ROWS	37.09	34.29	29.8	23.8	20.32
PHEC40R-S21	20/ROW X 2 ROWS	40.9	38.1	33.61	27.61	24.13
PHEC50R-S21	25/ROW X 2 ROWS	47.25	44.45	39.96	33.96	30.48
PHEC60R-S21	30/ROW X 2 ROWS	53.6	50.8	46.31	40.31	36.83
PHEC68R-S21	34/ROW X 2 ROWS	58.68	55.88	51.39	45.39	41.91
PHEC80R-S21	40/ROW X 2 ROWS	66.3	63.5	59.01	53.01	49.53
PHEC100R-S21	50/ROW X 2 ROWS	79.0	76.2	71.71	65.71	62.23
PHEC120R-S21	60/ROW X 2 ROWS	91.7	88.9	84.41	78.41	74.93

CONTACT PLATING TABLE

MATERIAL
 INSULATOR: PBT RESIN GLASS REINFORCED (UL-94V-0)
 COLOR: BLACK

CONTACT: PHOSPHOR BRONZE
 MOUNTING LATCH: PHOSPHOR BRONZE
 SOLDER PLATED

CONTACT AREA	REMAINDER
GOLD 0.25 MIN. OVER NICKEL 3.2	SOLDER OVER NICKEL

DRAWING NO.
 JSC 90737

PRINTED CIRCUIT CONNECTOR
 CAT. NO. PHEC...R-S21
 DRAWING NO. JSC 90737
 REV. 4
BURNDY JAPAN, Ltd.

DESIGNED
 DRAWN *M. Oba*
 CHECKED *A. Ch*
 APPROVED *J. Nakagishi*
 DATE Mar. 8, 1990

SCALE
 DIM. IN mm
 MATERIAL

REV. DATE	DESCRIPTION	CKD
4-1-29	WRONG CONTACT DIM. CORRECTED.	
3-8-11	30,34,50,68 POSITIONS ADDED No. 5.9	
2-5-30	EC 7866 No. JK	
1-4-20	EC 7837 No. JK	

DRAWING NO.
JSC 90739

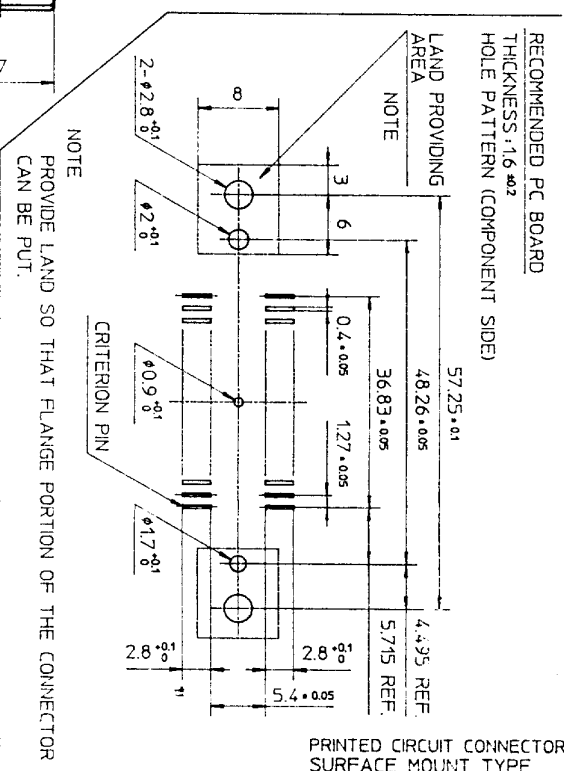
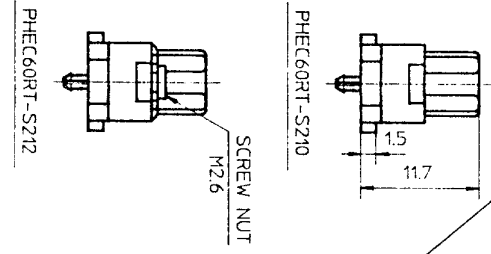
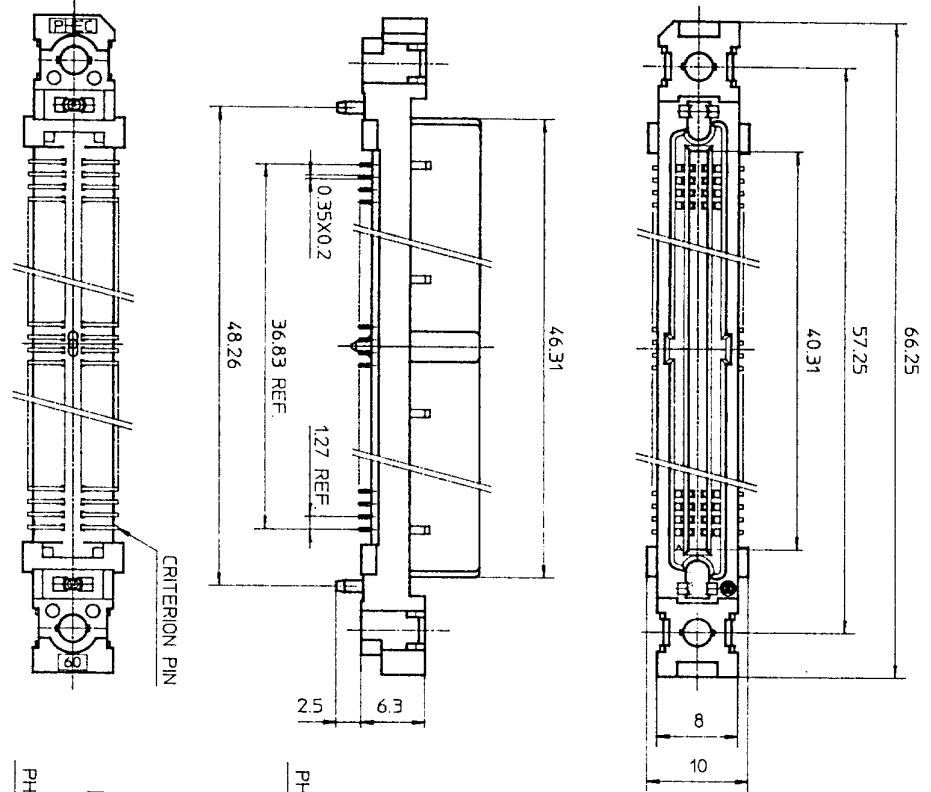

MATERIAL
INSULATOR : PPS RESIN GLASS REINFORCED (UL94V-0)
COLOR : BLACK
CONTACT : PHOSPHOR BRONZE
SCREW NUT : STAINLESS
NO. OF CONTACTS : 30/ROW X 2 ROWS (MATING SIDE)

CONTACT PLATING TABLE
(THICKNESS : μm)

CONTACT AREA	REMAINDER
GOLD 0.25 MIN.	SOLDER
OVER NICKEL 3Z	OVER NICKEL

TOLERANCES
UNLESS OTHERWISE SPECIFIED : ±0.3

PRINTED CIRCUIT CONNECTOR
SURFACE MOUNT TYPE

REV	DATE	DESCRIPTION	CHK.
4	'92 8-14	WRONG CONTACT DIM. CORRECTED 100 POSITIONS OF DELETED.	M. Oba
3	'92 1-8	DIM. CHANGED.	J. Kobayashi
2	'90 6-8	EC7866	J. Kobayashi
1	'90 4-20	VARIATION ADDED.	J. Kobayashi

SCALE	1:1
DIM IN	mm
MATERIAL	

DESIGNED	
DRAWN	M. Oba
CHECKED	J. Kobayashi
APPROVED	J. Kobayashi
DATE	Mar. 8, 1990

CAT. NO.	PHEC60RT-S212
DRAWING NO.	JSC 90739
REV	4

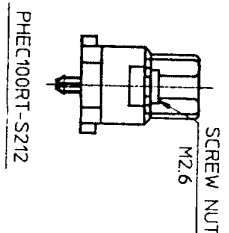
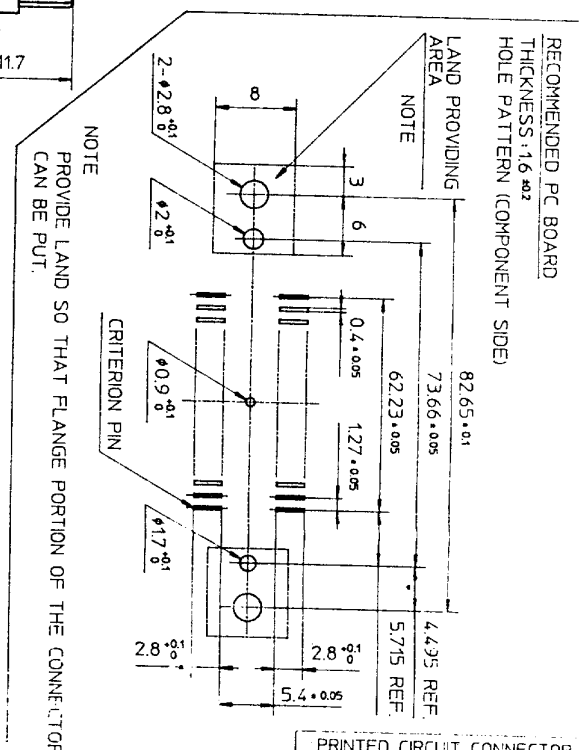
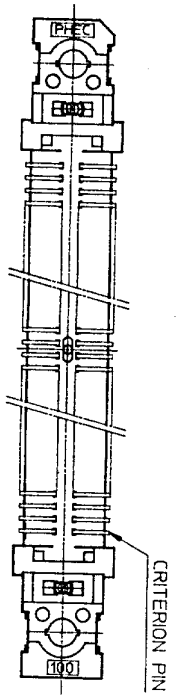
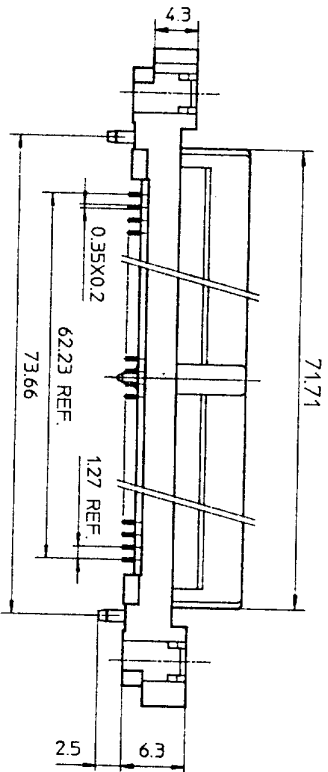
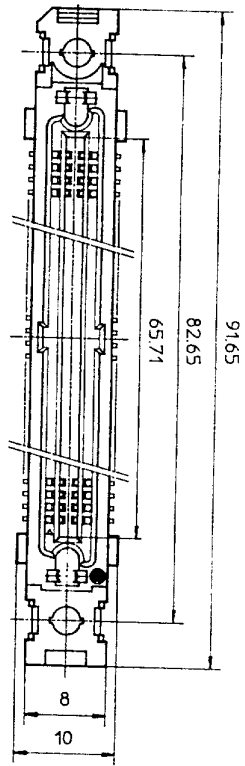

TOLERANCES
UNLESS OTHERWISE SPECIFIED: ±0.3

MATERIAL
INSULATOR: PPS RESIN GLASS REINFORCED (UL94V-0)
COLOR: BLACK
CONTACT: PHOSPHOR BRONZE
SCREW NUT: STAINLESS
NO. OF CONTACTS: 50/ROW X 2 ROWS (MATING SIDE)

CONTACT PLATING TABLE

CONTACT AREA	REMAINDER
GOLD 0.25 MIN OVER NICKEL 3.2	SOLDER OVER NICKEL

(THICKNESS: μm)

PRINTED CIRCUIT CONNECTOR
SURFACE MOUNT TYPE

CAT. NO. PHEC100RT-S21L

DRAWING NO. JSC 91839 REV. 0

BURNDY
JAPAN, Ltd.

DESIGNED: [Signature]
DRAWN: [Signature]
CHECKED: A. [Signature]
APPROVED: [Signature]
DATE: Aug. 11, 1992

SCALE: [Symbol]
DIM. IN: mm
MATERIAL:

REV.	DATE	DESCRIPTION	CHKD.

REFERENCE

DRAWING NO. JSC 91839

DRAWING NO. JSC 90752

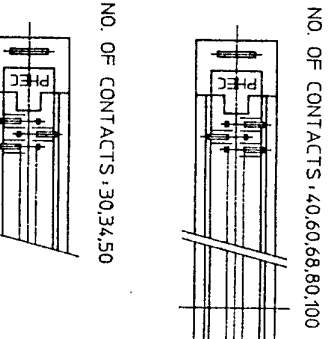
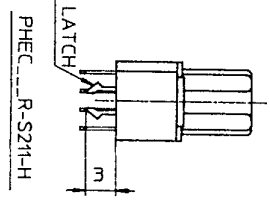
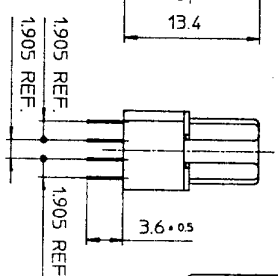
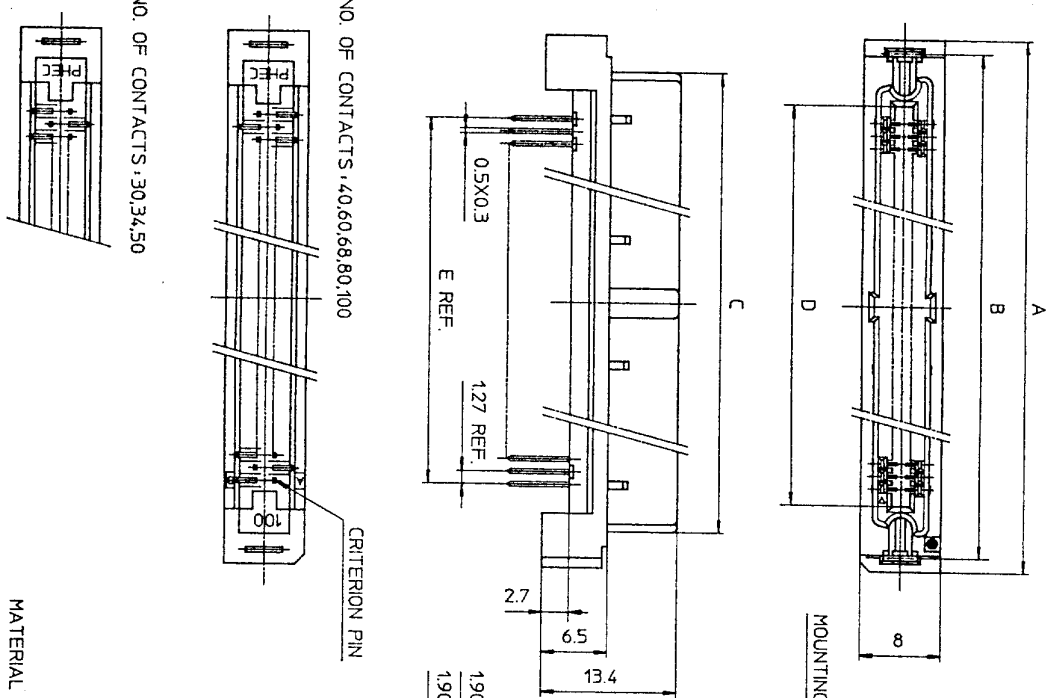

MATERIAL

INSULATOR: PBT RESIN GLASS REINFORCED (UL94V-0)
COLOR: BLACK

CONTACT: PHOSPHOR BRONZE
MOUNTING LATCH: PHOSPHOR BRONZE
SOLDER PLATED

CAT. NO.	NO. OF CONTACTS (MATING SIDE)	DIMENSIONS				
		A	B	C	D	E
PHEC30R-S21-H	15/ROW X 2 ROWS	34.55	31.75	27.26	21.26	17.78
PHEC34R-S21-H	17/ROW X 2 ROWS	37.09	34.29	29.8	23.8	20.32
PHEC40R-S21-H	20/ROW X 2 ROWS	40.9	38.1	33.61	27.61	24.13
PHEC50R-S21-H	25/ROW X 2 ROWS	47.25	44.45	39.96	33.96	30.48
PHEC60R-S21-H	30/ROW X 2 ROWS	53.6	50.8	46.31	40.31	36.83
PHEC68R-S21-H	34/ROW X 2 ROWS	58.68	55.88	51.39	45.39	41.91
PHEC80R-S21-H	40/ROW X 2 ROWS	66.3	63.5	59.01	53.01	49.53
PHEC100R-S21-H	50/ROW X 2 ROWS	79.0	76.2	71.71	65.71	62.23

TOLERANCES UNLESS OTHERWISE SPECIFIED: ±0.3

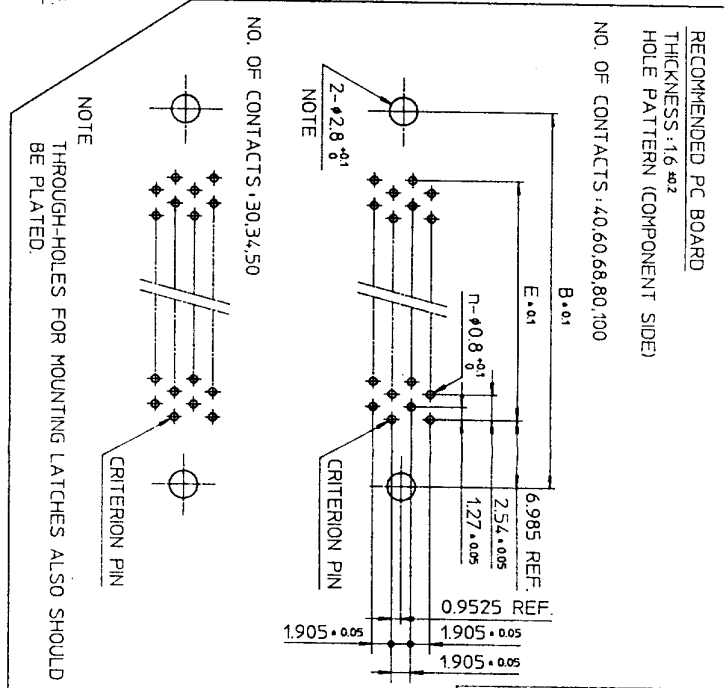

NOTE: THROUGH-HOLES FOR MOUNTING LATCHES ALSO SHOULD BE PLATED.

RECOMMENDED PC BOARD THICKNESS: 1.6 ±0.2
HOLE PATTERN (COMPONENT SIDE)
NO. OF CONTACTS: 40,60,68,80,100

CONTACT PLATING TABLE (THICKNESS: μm)

CONTACT AREA	REMAINDER
GOLD 0.25 MIN	SOLDER
OVER NICKEL 3.2	OVER NICKEL

REV	DATE	DESCRIPTION	CHKD.
5	93-6-22	100 POSITIONS ADDED.	M.O
4	93-2-1	WRONG CONTACT DIM. CORRECTED.	no
3	92-8-11	100,120 POSITIONS DELETED. 30,34,50,68 POSITIONS ADDED.	no
2	90-5-30	DIM. CHANGED (36.61 → 33.61)	no
1	90-5-14	EC 7866	HE

SCALE: 1:1
DIM. IN: mm

DESIGNED: M. Oga
DRAWN: M. Oga
CHECKED: A. Oga
APPROVED: J. Oga
DATE: Mar. 24, 1990

PRINTED CIRCUIT CONNECTOR HIGH STAND OFF TYPE

CAT. NO. PHEC...R-S21-H

DRAWING NO. JSC 90752 REV. 5

BURNDY JAPAN, Ltd.

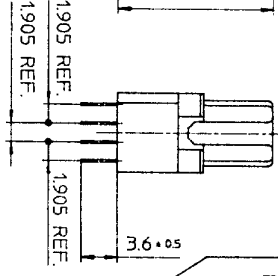
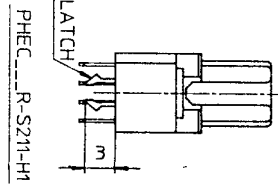
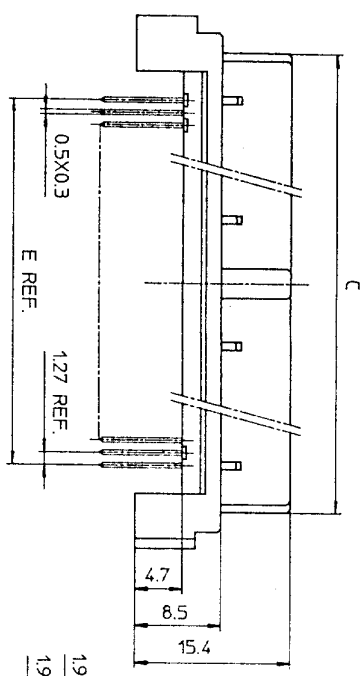
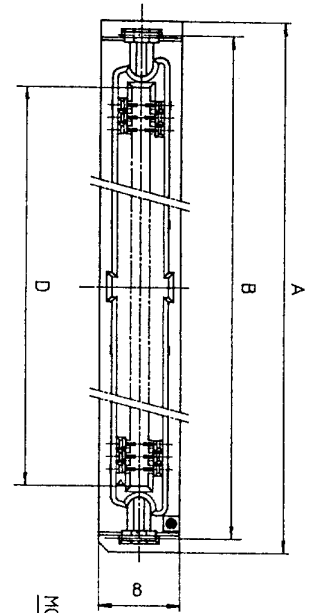

RECOMMENDED PC BOARD
THICKNESS: 1.6 ± 0.2
HOLE PATTERN (COMPONENT SIDE)
NO. OF CONTACTS: 40,60,68

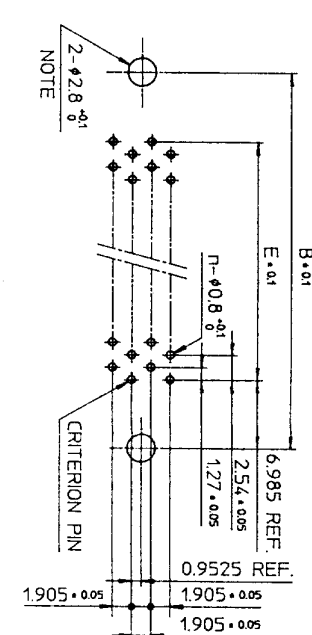

NOTE
THROUGH-HOLES FOR MOUNTING LATCHES ALSO SHOULD BE PLATED.
CRITERION PIN

NO. OF CONTACTS: 40,60,68

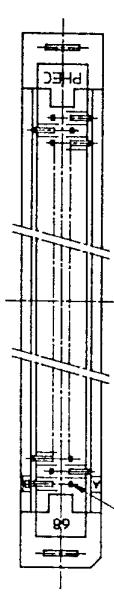

NO. OF CONTACTS: 30,34,50

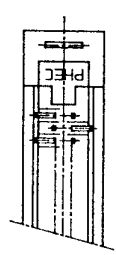

CAT. NO.	NO. OF CONTACTS (MATING SIDE)	DIMENSIONS				
		A	B	C	D	E
PHEC30R-S21-H1	15/ROW X 2 ROWS	34.55	31.75	27.26	21.26	17.78
PHEC34R-S21-H1	17/ROW X 2 ROWS	37.09	34.29	29.8	23.8	20.32
PHEC40R-S21-H1	20/ROW X 2 ROWS	40.9	38.1	33.61	27.61	24.13
PHEC50R-S21-H1	25/ROW X 2 ROWS	47.25	44.45	39.96	33.96	30.48
PHEC60R-S21-H1	30/ROW X 2 ROWS	53.6	50.8	46.31	40.31	36.83
PHEC68R-S21-H1	34/ROW X 2 ROWS	58.68	55.88	51.39	45.39	41.91

TOLERANCES
UNLESS OTHERWISE SPECIFIED: ±0.3

MATERIAL

INSULATOR: PBT RESIN GLASS REINFORCED (UL94V-0)
COLOR: BLACK

CONTACT: PHOSPHOR BRONZE
MOUNTING LATCH: PHOSPHOR BRONZE
SOLDER PLATED

CONTACT PLATING TABLE

CONTACT AREA	REMAINDER
GOLD 0.25 MIN. OVER NICKEL 3.2	SOLDER OVER NICKEL

DRAWING NO. JSC 91840

PRINTED CIRCUIT CONNECTOR
HIGH STAND OFF TYPE
CAT. NO. PHEC__R-S21-H1
DRAWING NO. JSC 91840
REV. 1
BURNDY JAPAN, Ltd.

DESIGNED
DRAWN *M. Oba*
CHECKED A. matsuo
APPROVED *S. Ito*
DATE Aug. 17, 1992

SCALE 1:1
DIM IN mm
MATERIAL

REV	DATE	DESCRIPTION	CKD
1	93-2-1	WRONG CONTACT DIM. CORRECTED.	

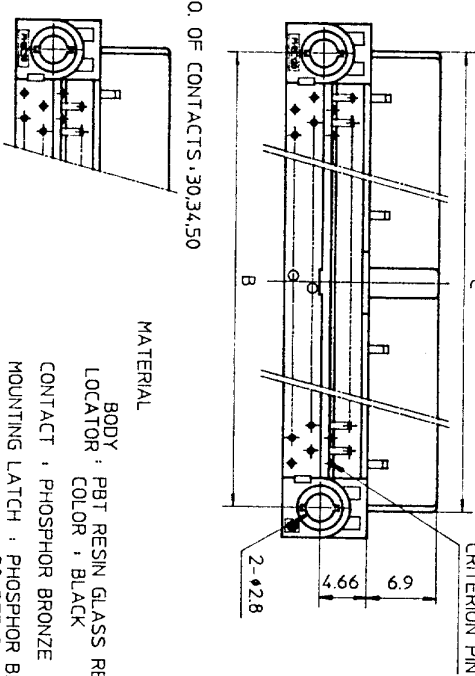
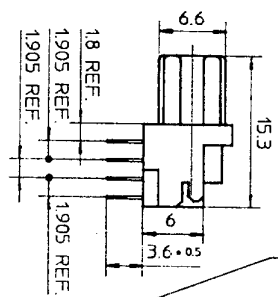
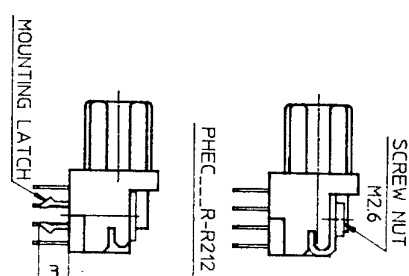
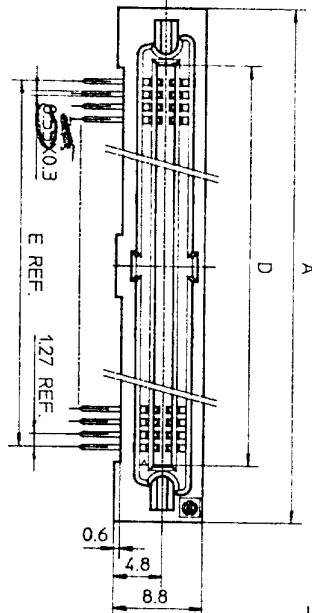
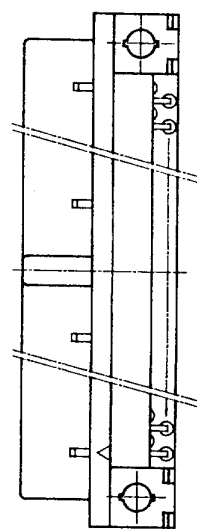

NO. OF CONTACTS : 30,34,50

NO. OF CONTACTS : 40,60,68,80,100,120

MATERIAL
BODY : PBT RESIN GLASS REINFORCED (UL94V-0)
LOCATOR COLOR : BLACK
CONTACT : PHOSPHOR BRONZE
MOUNTING LATCH : PHOSPHOR BRONZE
SCREW NUT : STEEL
NICKEL PLATED

CAT. NO.	NO. OF CONTACTS (MATING SIDE)	DIMENSIONS				
		A	B	C	D	E
PHEC30R-R21	15/ROW X 2 ROWS	32.67	26.67	27.26	21.26	17.78
PHEC34R-R21	17/ROW X 2 ROWS	35.21	29.21	29.8	23.8	20.32
PHEC40R-R21	20/ROW X 2 ROWS	39.02	33.02	33.61	27.61	24.13
PHEC50R-R21	25/ROW X 2 ROWS	45.37	39.37	39.96	33.96	30.48
PHEC60R-R21	30/ROW X 2 ROWS	51.72	45.72	46.31	40.31	36.83
PHEC68R-R21	34/ROW X 2 ROWS	56.8	50.8	51.39	45.39	41.91
PHEC80R-R21	40/ROW X 2 ROWS	64.42	58.42	59.01	53.01	49.53
PHEC100R-R21	50/ROW X 2 ROWS	77.12	71.12	71.71	65.71	62.23
PHEC120R-R21	60/ROW X 2 ROWS	89.82	83.82	84.41	78.41	74.93

CONTACT PLATING TABLE
(THICKNESS : μm)

CONTACT AREA	REMAINDER
GOLD 0.25 MIN.	SOLDER
OVER NICKEL 3.2	OVER NICKEL

RECOMMENDED PC BOARD
THICKNESS : 1.6 ±0.2
HOLE PATTERN (COMPONENT SIDE)
NO. OF CONTACTS : 40,60,68,80,
100,120

n : NO. OF CONTACTS

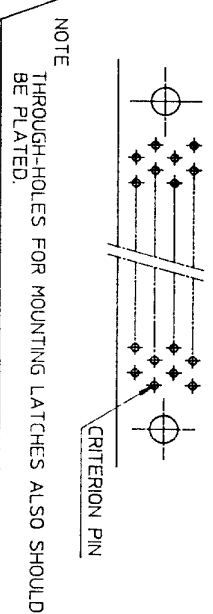
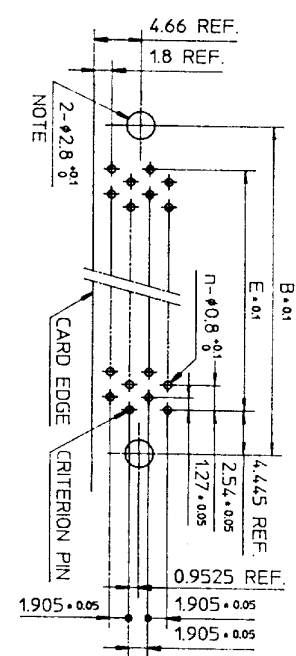

NOTE
THROUGH-HOLES FOR MOUNTING LATCHES ALSO SHOULD BE PLATED.
TOLERANCES UNLESS OTHERWISE SPECIFIED : ±0.3

DRAWING NO
JSC 90738

REV. DATE	DESCRIPTION	CKD	SCALE	DESIGNED	PRINTED CIRCUIT CONNECTOR
3 8-11	30,34,50,68 POSITIONS ADDED.	1.2	DIM. IN mm	M. Osa	CAT. NO. PHEC...R-R21
2 6-8	EC 7866	2.0	MATERIAL	CHECKED 4. Ely	DRAWING NO. JSC 90738
1 4-20	EC 7837	2.0		APPROVED J. Yamashita	REV. 3
REFERENCE				DATE Mar. 8, 1990	BURNDY JAPAN, Ltd.