

PRODUCT NO.	SEE DIAGRAM SH. 2
SHEET INDEX	
SHEET 1	TITLE SHEET
SHEET 2	PART NUMBER AND MATED HEIGHT INFO.
SHEET 3	VERTICAL RECEPTACLE WITH HOOK
SHEET 4	VERTICAL RECEPTACLE WITHOUT HOOK
SHEET 5	RIGHT ANGLE RECEPTACLE
SHEET 6	RIGHT ANGLE HEADER
SHEET 7	VERTICAL HEADER WITH HOOK
SHEET 8	VERTICAL HEADER WITHOUT HOOK

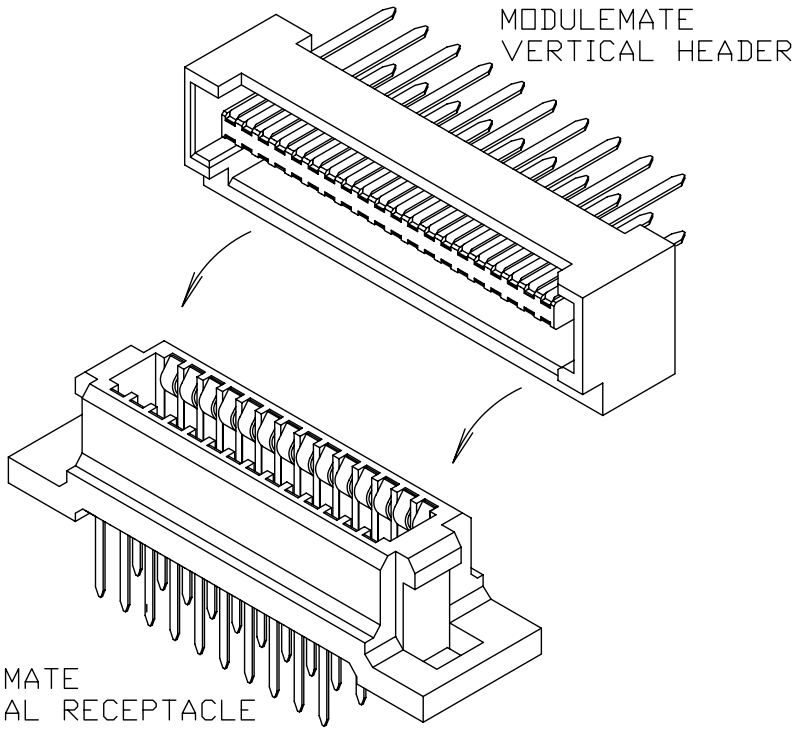

FEATURES:

- PITCH = 1.27mm/.05 AT CONTACT INTERFACE
- POSTURE: RIGHT ANGLE RECEPTACLE
RIGHT ANGLE HEADER
VERTICAL RECEPTACLE
VERTICAL HEADER
- NUMBER OF POSITIONS:
20,30,40,50,60,80,100,120
- MATED HEIGHTS, VERTICAL POSTURE:
7,8,9,10,12,MM
- PCB RETENTION HOOK ON ALL RIGHT ANGLE ASSEMBLIES, OPTIONAL ON VERTICAL ASSEMBLIES
- RECEPTACLE TERMINAL MATERIAL:
PHOS-BRONZE WITH 15u"/0.38u MIN GXT IN CONTACT AREA AND 100u"/2.54u MIN SnPb IN SOLDER TAIL AREA
HEADER TERMINAL MATERIAL:
PHOS-BRONZE WITH 15u"/0.38u MIN GXT IN CONTACT AREA AND 100u"/2.54u MIN SnPb IN SOLDER TAIL AREA
HOUSING MATERIAL: LCP, COLOR IS BLACK
- P/N'S WITH SUFFIX "LF" ARE LEAD FREE P/N'S. FOR LEAD FREE P/N'S, ALL SnPb PLATING WILL BE SUBSTITUTED BY PURE TIN
- PACKING STANDARD GS-14-920 WILL BE APPLIED FOR LEAD FREE P/N'S
- FOR LEAD FREE P/N, THE PRODUCT MEET EUROPEAN UNION DIRECTIVES AND OTHER COUNTRY REGULATION AS DESCRIBED IN GS-22-008
- FOR LEAD FREE P/N, THE HOUSING WILL WITHSTAND EXPOSURE TO 260°C PEAK TEMPERATURE FOR 40 SECONDS IN A CONVECTION, INFRO-RED OR VAPOR PHASE REFLOW OVEN.

MODULEMATE VERTICAL RECEPTACLE

mat'l. code				tolerances unless otherwise specified		CUSTOMER COPY		FCI www.fciconnect.com	
ltr	ecm no	dr	date	linear	.X ± 0.3	projection	title MODULEMATE CONNECTOR ASSEMBLY		
H	V11178	TAI	05/09/01		.XX ± 0.13	MM	product family MODULEMATE code		
J	N05-0269	PH	09/28/05		.XXX ± 0.05		size		
K	N06-0304	LONG	12/04/06	angles	0° ± 2°	scale	A3	95747	sheet 1 of 8
E	T60403	L S	10/5/96	dr	KENNY TAI	05/09/01	dwg no		
F	T70121	L S	03/27/97	enr	KENNY TAI	05/09/01	sheet		
G	T80299	CH	07/13/98	chr	KENNY TAI	05/09/01	1 of 8		
sheet index	revision sheet	K	J	K	J	K	J	J	
		1	2	3	4	5	6	7	8

PDM! Rev:K STATUS:Released Printed: Nov 09, 2010 6

MODULEMATE ASSEMBLY PRODUCT
NUMBERS, HEADERS AND RECEPTACLES
PRODUCT NUMBER 9 5 7 G P - N N H

GENDER	CODE
HEADER	4
RECEPTACLE	5

POSTURE	CODE
RIGHT ANGLE	7
VERTICAL W/HOOK	8
VERTICAL W/O HOOK	9

CODE	MATING DISTANCE	
	HEADER	RECEPTACLE
SEE TABLES 1 FOR VERTICAL MATING; TABLE 2 FOR HORIZONTAL MATING, AND TABLES 3 AND 4 FOR RIGHT ANGLE MATING		

CODE	TOTAL NUMBER OF POSITIONS
02	20
03	30
04	40
05	50
06	60
08	80
10	100
12	120

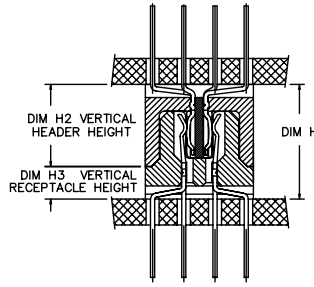

HEADER CODE	RECEPTACLE CODE	MATED HEIGHT	DIM H2	DIM H3
5	2	7	5	2
5	3	8	5	3
7	2	9	7	2
7	3	10	7	3
5	5	10	5	5
7	5	12	7	5

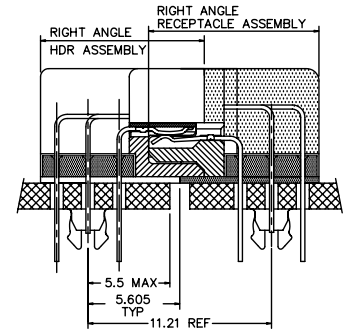

HEADER CODE	RECEPTACLE CODE	
8	8	RIGHT ANGLE HEADER TO RIGHT ANGLE RECEPTACLE

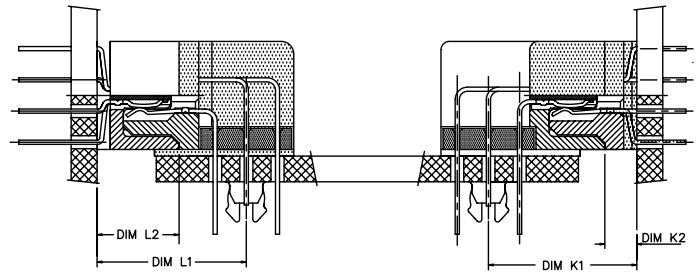

HEADER CODE	RECEPTACLE CODE		L1	L2
5	8	VERTICAL HEADER TO RIGHT ANGLE RECEPT.	9.105	5
7	8		11.105	7

HEADER CODE	RECEPTACLE CODE		K1	K2
8	2	RIGHT ANGLE HEADER TO VERTICAL RECEPTACLE	9.06	2
8	3		10.06	3
8	5		12.06	5

mat'l. code				tolerances unless otherwise specified		CUSTOMER COPY		FCJ www.fcjconnect.com	
ltr	ecn	no	dr	date	linear	.X ± 0.3	projection	title	
						.XX ± 0.13		MODULEMATE CONNECTOR ASSEMBLY	
					angles	.XXX ± 0.05	MM	product family MODULEMATE	
						0° ± 2°		size	
			dr	KENNY TAI	05/09/01		scale	A3	
			enr	KENNY TAI	05/09/01			95747	
			chr	KENNY TAI	05/09/01		sheet		
			appd	PAUL WANG	05/09/01		2 of		
sheet index	revision	sheet							

PRODUCT NUMBER	POS.	DIM A	DIM B	DIM E	DIM P	TYPE	COMMENTS
95758-022/022LF	20	25.43	20.32	11.43	5.4	STYLE I	AVAILABLE
-032	30	31.78	26.67	17.78			
-042	40	38.13	33.02	24.13			
-052	50	44.48	39.37	30.48			
-062/062LF	60	50.83	45.72	36.83			
-082	80	63.53	58.42	49.53			NOT TOOLED
-102	100	76.23	71.12	62.23			
95758-122	120	88.93	83.82	74.93	5.4	STYLE I	
95758-023	20	25.43	20.32	13.43	6.4	STYLE I	
-033	30	31.78	26.67	19.78			
-043	40	38.13	33.02	26.13			NOT TOOLED
-053	50	44.48	39.37	32.48			
-063	60	50.83	45.72	38.83			
-083	80	63.53	58.42	51.53			
-103	100	76.23	71.12	64.23			
95758-123	120	88.93	83.82	76.93	6.4	STYLE I	NOT TOOLED
95758-025	20	25.43	20.32	13.43	8.4	STYLE II	
-035	30	31.78	26.67	19.78			
-045	40	38.13	33.02	26.13			
-055	50	44.48	39.37	32.48			
-065	60	50.83	45.72	38.83			NOT TOOLED
-085	80	63.53	58.42	51.53			
-105	100	76.23	71.12	64.23			
95758-125	120	88.93	83.82	76.93	8.4	STYLE II	

VERTICLE RECEPTACLE WITH HOOKS SHOWN ON THIS SHEET

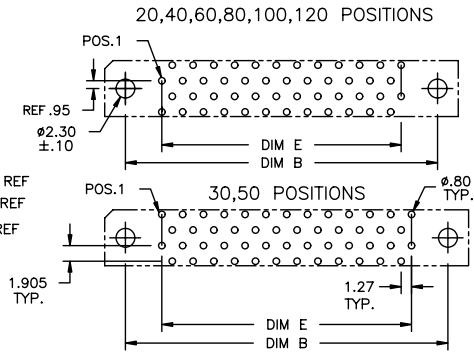
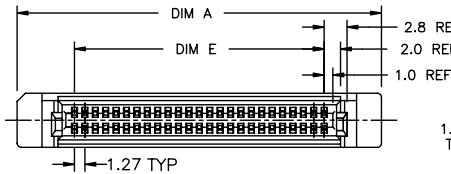

RECOMMENDED PCB LAYOUT

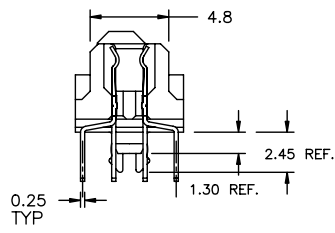
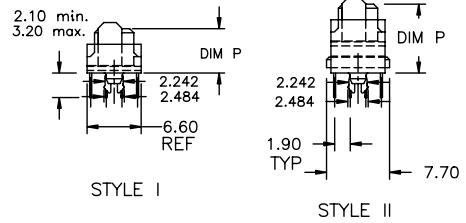
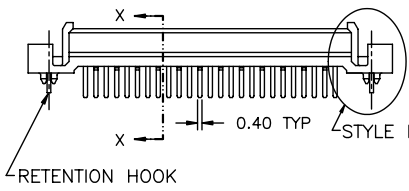

SECTION X-X
STYLE I

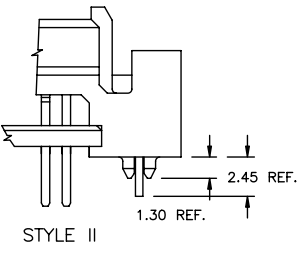

STYLE II

mat'l. code		tolerances unless otherwise specified		CUSTOMER COPY		FCJ www.fcjconnect.com	
ltr	ecm no	dr	date	linear	.X ± 0.3	projection	title
K					.XX ± 0.13	MM	MODULEMATE CONNECTOR ASSEMBLY
				angles	.XXX ± 0.05	scale	product family
				dr	0° ± 2°	A3	MODULEMATE
				enr			code
				chr			95747
				appd			sheet
sheet	revision						3 of
index	sheet						

All rights reserved. No part of this document may be reproduced, stored in a retrieval system, or transmitted in any form or by any means, electronic, mechanical, photocopying, recording, or by any information storage and retrieval system, without the prior written permission of FCJ.

PRODUCT NUMBER	POS.	DIM A	DIM E	DIM P	TYPE	COMMENTS	
95759-022	20	18.83	11.43	5.4	STYLE I	AVAILABLE	
-032	30	25.18	17.78	NOT TOOLED			
-042	40	31.53	24.13				
-052	50	37.88	30.48				
-062	60	44.23	36.83	AVAILABLE			
-082	80	56.93	49.53				
95759-122	120	82.33	74.93	5.4	STYLE I		
95759-023	20	18.83	13.43	6.4		STYLE I	NOT TOOLED
-033	30	25.18	19.78				
-043	40	31.53	26.13				
-053	50	37.88	32.48				
-063	60	44.23	38.83				
-083	80	56.93	51.53				
95759-123	120	82.33	76.93	6.4	STYLE II		
95759-025	20	18.83	13.43	8.4		STYLE II	
-035	30	25.18	19.78				
-045	40	31.53	26.13				
-055	50	37.88	32.48				
-065	60	44.23	38.83				
-085	80	56.93	51.53				
95759-125	120	82.33	76.93	8.4			

VERTICLE RECEPTACLE WITHOUT HOOK SHOWN ON THIS SHEET

RECOMMENDED PCB LAYOUT

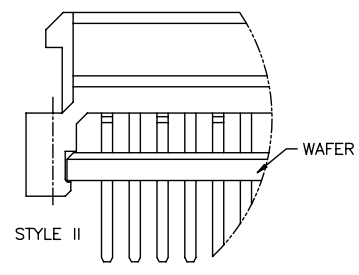
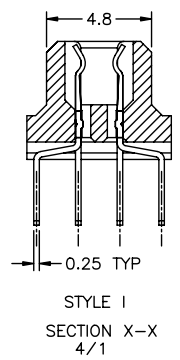
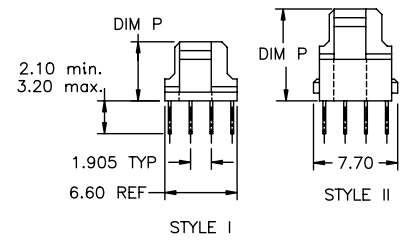
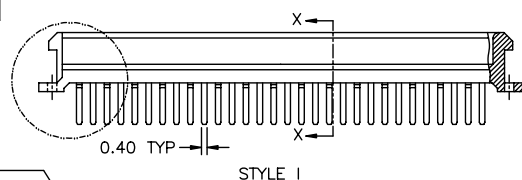
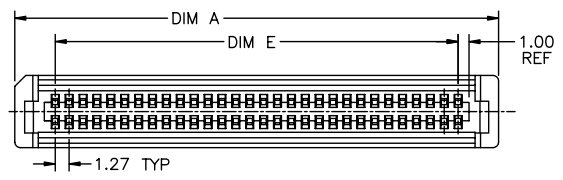
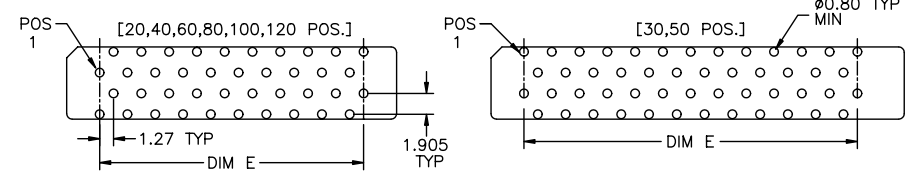

mat'l. code		tolerances unless otherwise specified		CUSTOMER COPY	FCJ www.fcconnect.com
ltr	ecn no	dr	date	linear	
J				.X ± 0.3	MM
				.XX ± 0.13	
				.XXX ± 0.05	
				angles	0° ± 2°
		dr	KENNY TAI 05/09/01		product family
		enr	KENNY TAI 05/09/01		MODULEMATE
		chr	KENNY TAI 05/09/01		size
		appd	PAUL WANG 05/09/01		dwg no
				scale	A3
sheet index	revision sheet				product family
					MODULEMATE
					code
					95747
					sheet
					4 of

All rights reserved. Reproduction or use in any form without the prior written permission of FCI is prohibited. FCI and the FCI logo are registered trademarks of FCI. © FCI 2010. All rights reserved.

PRODUCT NO.	POS.	DIM A	DIM B	DIM E	COMMENTS
95757-028	20	25.43	20.32	11.43	NOT TOOLED
-038	30	31.78	26.67	17.78	
-048	40	38.13	33.02	24.13	
-058	50	44.48	39.37	30.48	
-068	60	50.83	45.72	36.83	
-088	80	63.53	58.42	49.53	
95757-128	120	88.93	83.82	74.93	

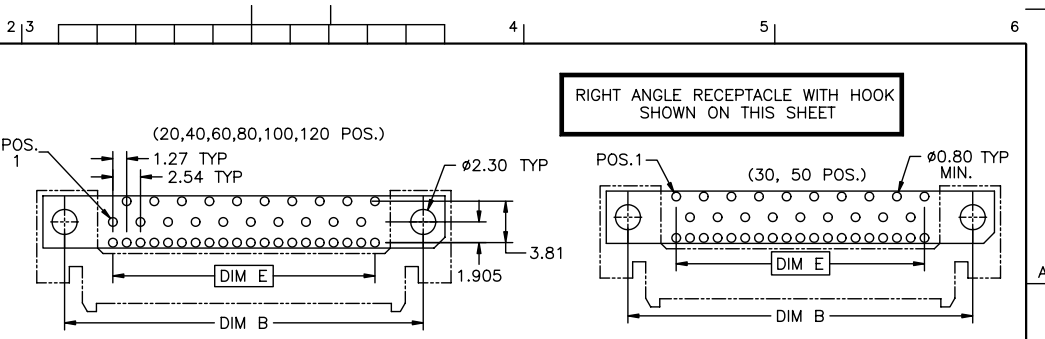

RECOMMENDED PCB LAYOUT

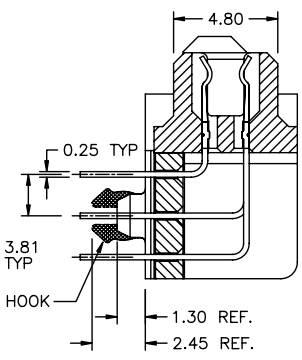
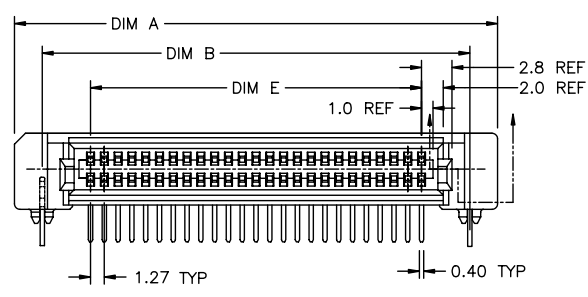

SECTION X-X
4/1

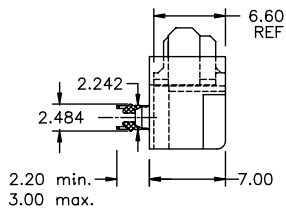

mat'l. code		tolerances unless otherwise specified		CUSTOMER COPY	www.fciconnect.com
ltr	scn no	dr	date	linear	
J				.X ± 0.3	MM
				.XX ± 0.13	title
				.XXX ± 0.05	MODULEMATE
				angles 0°±2°	CONNECTOR ASSEMBLY
		dr	KENNY TAI 05/09/01	scale	product family
		enrg	KENNY TAI 05/09/01	--- A3	MODULEMATE
		chr	KENNY TAI 05/09/01		code
		appd	PAUL WANG 05/09/01		95747
sheet	revision				size
index	sheet				dwg no
					5 of 5

PRODUCT NO.	POS.	DIM A	DIM B	DIM E	COMMENTS
95747-028/028LF	20	25.43	20.32	11.43	AVAILABLE
-038	30	31.78	26.67	17.78	NOT TOOLED
-048	40	38.13	33.02	24.13	AVAILABLE
-058	50	44.48	39.37	30.48	
-068	60	50.83	45.72	36.83	
-088	80	63.53	58.42	49.53	NOT TOOLED
-108	100	76.23	71.12	62.23	
95747-128	120	88.93	83.82	74.93	

RIGHT ANGLE HEADER WITH HOOK SHOWN ON THIS SHEET

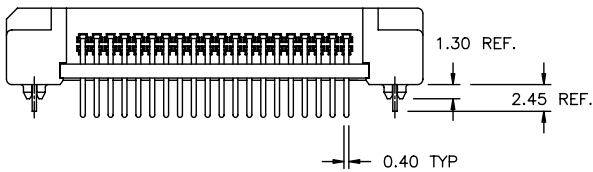
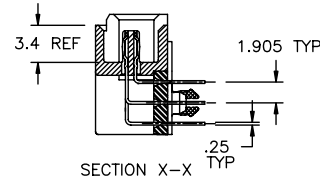
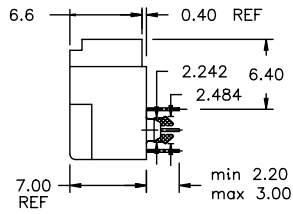
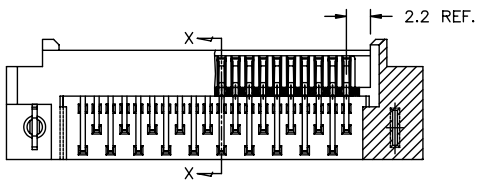
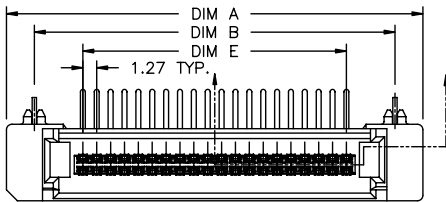
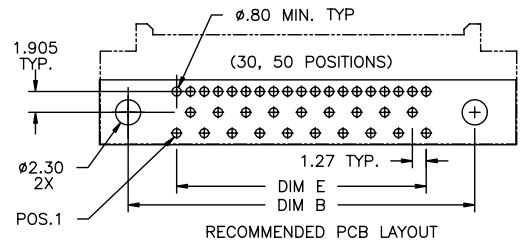
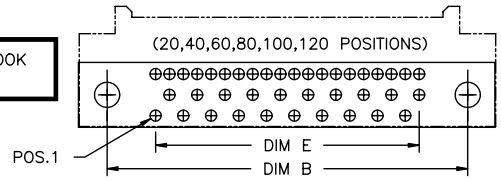

mat'l. code		tolerances unless otherwise specified		CUSTOMER COPY		 www.fciconnect.com	
ltr	ecm no	dr	date	linear	.X ± 0.3	projection	title MODULEMATE CONNECTOR ASSEMBLY
K					.XX ± 0.13	 MM	
				angles	.XXX ± 0.05		scale
					0° ± 2°	A3	95747
				dr	KENNY TAI 05/09/01		sheet
				enr	KENNY TAI 05/09/01		6 of
				chr	KENNY TAI 05/09/01		
				appd	PAUL WANG 05/09/01		
sheet	revision						
index	sheet						

PRODUCT NO.	POS.	DIM A	DIM B	DIM E	STYLE	COMMENTS
95748-025	20	25.43	20.32	11.43	STYLE I	NOT TOOLED
-035	30	31.78	26.67	17.78		
-045	40	38.13	33.02	24.13		
-055	50	44.48	39.37	30.48		
-065	60	50.83	45.72	36.83		
-085	80	63.53	58.42	49.53		
-105	100	76.23	71.12	62.23		
95748-125	120	88.93	83.82	74.93	STYLE II	
95748-027	20	25.43	20.32	11.43		
-037	30	31.78	26.67	17.78		
-047	40	38.13	33.02	24.13		
-057	50	44.48	39.37	30.48		
-067	60	50.83	45.72	36.83		
-087	80	63.53	58.42	49.53		
-107	100	76.23	71.12	62.23		
95748-127	120	88.93	83.82	74.93		

VERTICLE HEADER WITH HOOK
SHOWN ON THIS SHEET

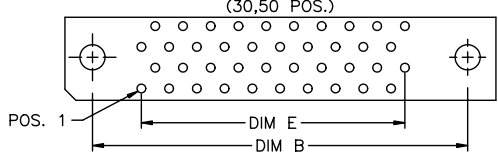
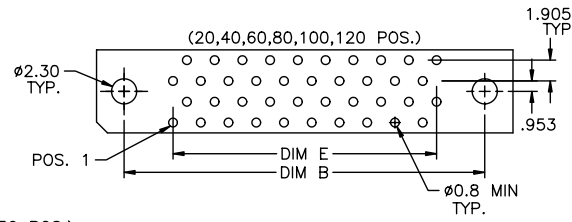

RECOMMENDED PCB LAYOUT

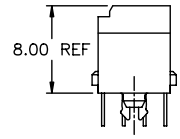
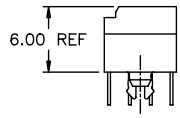
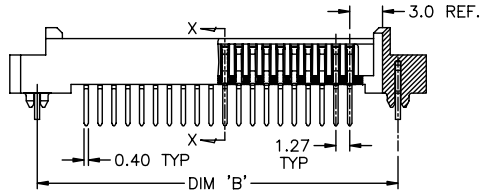
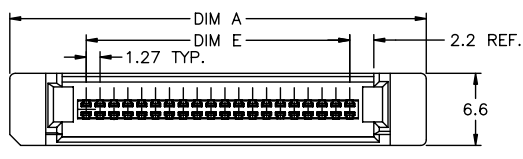

STYLE I

STYLE II

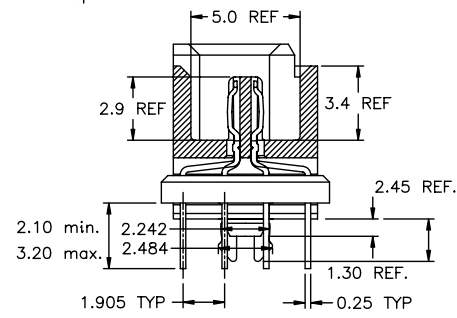

SECTION X-X

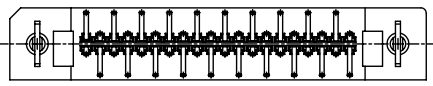

mat'l. code		tolerances unless otherwise specified		CUSTOMER COPY		FCJ www.fcjconnect.com	
ltr	ecr no	dr	date	linear	.X ± 0.3	projection	title
J					.XX ± 0.13	MM	MODULEMATE
				angles	.XXX ± 0.05		CONNECTOR ASSEMBLY
					0° ± 2°		product family
		dr	KENNY TAI 05/09/01				MODULEMATE
		enr	KENNY TAI 05/09/01				code
		chr	KENNY TAI 05/09/01				size
		appd	PAUL WANG 05/09/01			scale	dwg no
sheet	revision					A3	95747
index	sheet						sheet
							7 of

PRODUCT NO.	POS.	DIM A	DIM E	STYLE	COMMENTS
95749-025	20	18.83	14.23	STYLE I	NOT TOOLED
-035	30	25.48	20.58		
-045	40	31.53	26.93		
-055	50	37.88	33.28		
-065	60	44.23	39.63		
-085	80	56.93	52.33		
-105	100	69.63	65.03		
-125	120	82.33	77.73		
-027	20	18.83	14.23	STYLE II	
-037	30	25.48	20.58		
-047	40	31.53	26.93		
-057	50	37.88	33.28		
-067	60	44.23	39.63		
-087	80	56.93	52.33		
-107	100	69.63	65.03		
95749-127	120	82.33	77.73		

VERTICLE HEADER WITHOUT HOOK SHOWN ON THIS SHEET

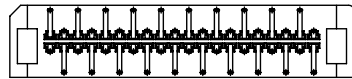
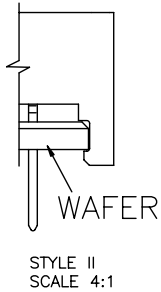
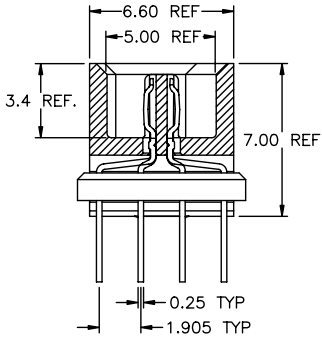
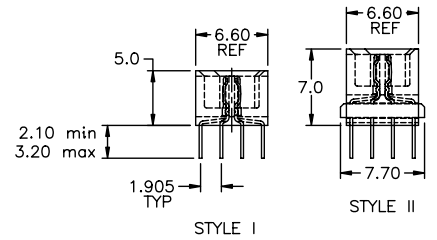
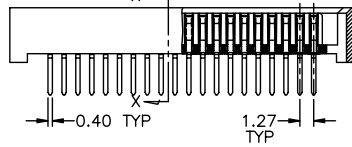
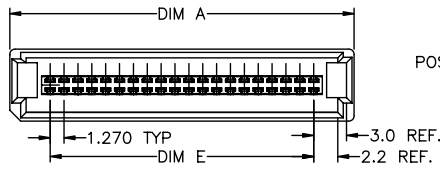
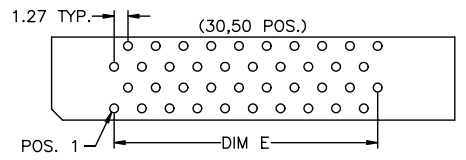
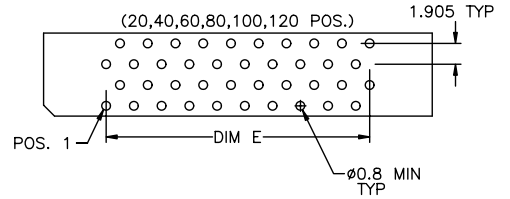

mat'l. code		tolerances unless otherwise specified		CUSTOMER COPY		FCJ www.fcjconnect.com	
ltr	ecm no	dr	date	linear	.X ± 0.3	projection	title
J					.XX ± 0.13	MM	MODULEMATE CONNECTOR ASSEMBLY
					.XXX ± 0.05		product family MODULEMATE
				angles	0° ± 2°	scale	size
dr	KENNY TAI	05/09/01				A3	95747
enr	KENNY TAI	05/09/01					code
chr	KENNY TAI	05/09/01					8 of
appd	PAUL WANG	05/09/01					
sheet index	revision sheet						