



SERIES MMBX MICRO MINIATURE BOARD CONNECTORS

DESCRIPTION

Modularity with a minimum space requirement is demanded for the existing and coming generation of systems (GSM 900 / 1800 / 1900, PCS, WCDMA, UMTS). To achieve this for all different systems, the smallest possible components must be used also for interconnections.

In order to reduce the variety of products and to achieve standardised systems (in other words: modularity), the HUBER+SUHNER Series MMBX™ (Micro Miniature Board Connector) contains a range of board and cable connectors which require a minimum of space. It offers all the necessary characteristics to obtain a unified design of the various systems.

CONTENTS

PAGE

Description	35
Interface dimensions	35
Interface dimensions in mm / inches	35
Technical data of cable connectors	37
Technical data of PCB connectors	38
Technical data of adaptors between series	39
Cable connectors	43
PCB connectors	45
Adaptors within-series	48
Tools	50

INTERFACE DIMENSIONS

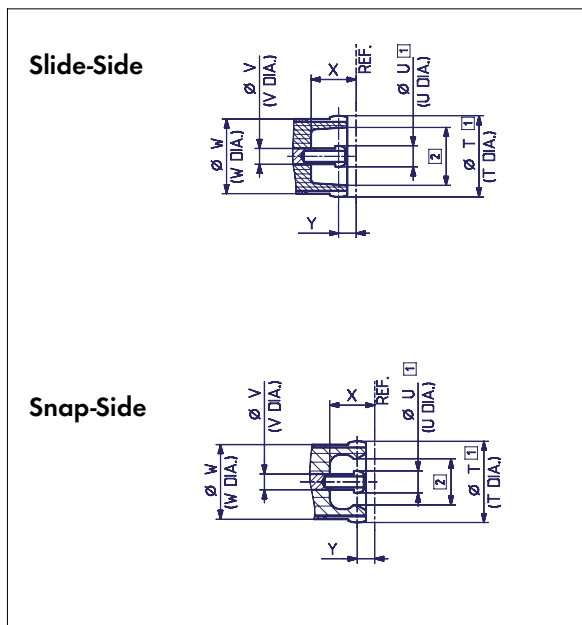

INTERFACE DIMENSIONS (MM / INCHES)

Adaptors Within-Series

	min. / max. mm	min. / max. inches
T	3.70 nom.	.146 nom.
U	0.95 nom.	.037 nom.
V	0.70 nom.	.028 nom.
W	3.65 nom.	.144 nom.
X	2.05 nom.	.081 nom.
Y	0.80 nom.	.032 nom.

- 1 Slotted and flared to meet electrical and mechanical requirements
- 2 Dimension to meet electrical and mechanical requirements

IP rating (interface, mated) IP50

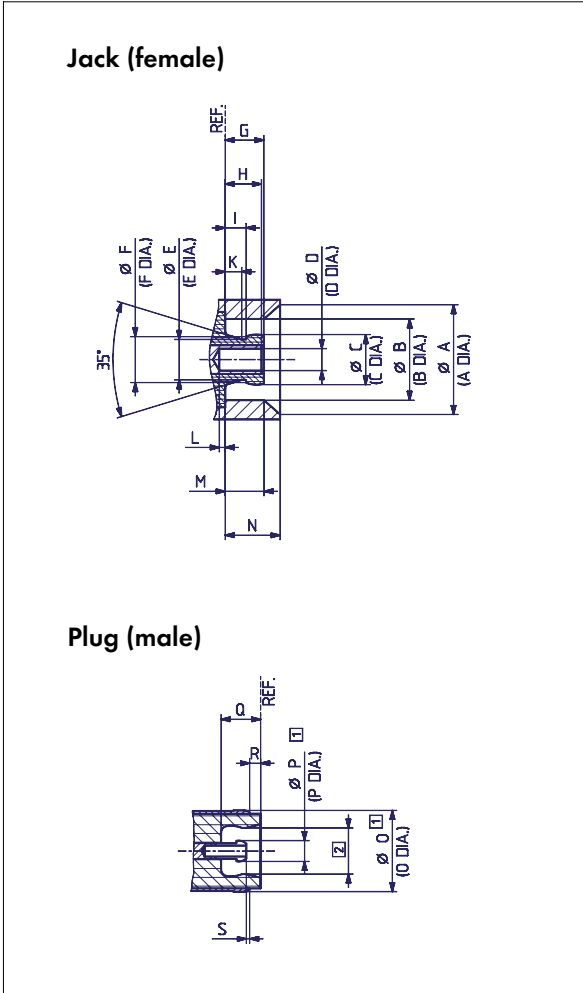

MMBX Connectors:

	min. mm	min. inches	max. mm	max. inches
A	5.00 nom.	.197 nom.	5.00 nom.	.197 nom.
B	3.68	.145	3.71	.146
C	2.25	.089	2.30	.091
D	0.98	.039	1.01	.040
E	1.85 nom.	.073 nom.	1.85 nom.	.073 nom.
F	2.10 nom.	.083 nom.	2.10 nom.	.083 nom.
G	—	—	1.80	.071
H	1.55	.061	1.75	.069
I	0.90	.035	—	—
K	0.75 nom.	.030 nom.	0.75 nom.	.030 nom.
L	0	0	—	—
M	1.45	.057	—	—
N	2.50 nom.	.098 nom.	2.50 nom.	.098 nom.
O	3.70 nom.	.146 nom.	3.70 nom.	.146 nom.
P	0.95 nom.	.037 nom.	0.95 nom.	.037 nom.
Q	1.85 nom.	.073 nom.	1.85 nom.	.073 nom.
R	0.50 nom.	.020 nom.	0.50 nom.	.020 nom.
S	0.10 nom.	.004 nom.	0.10 nom.	.004 nom.

- 1 Slotted and flared to meet electrical and mechanical requirements
- 2 Dimension to meet electrical and mechanical requirements

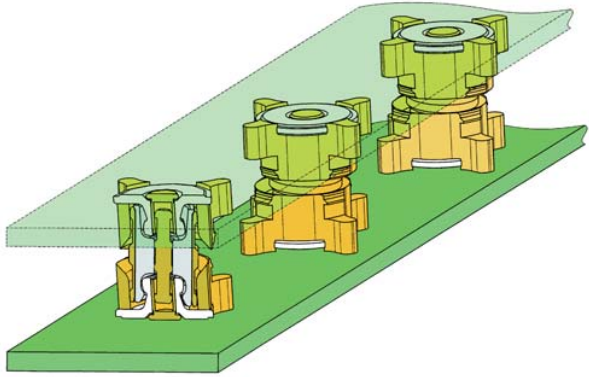

Direct interconnection with excellent electrical and mechanical properties.

TECHNICAL DATA OF CABLE CONNECTORS

ELECTRICAL DATA	CECC 22000	REQUIREMENTS
for cable groups		Y 11, U2, U4
Impedance		50 Ω
Frequency range		DC ... 12.4 GHz
Dielectric withstanding voltage (at sea level)	4.4.5	750 V rms, 50 Hz
Working voltage (at sea level) - unmated	IEC 169-1 14.6.1	250 V rms, 50 Hz (calculated)
Working voltage (at 21'000 m/70'000 ft.) - mated and unmated	Appendix C	42 VAC 50 Hz (calculated)
Insulation resistance	4.4.4	$\geq 1 \text{ G}\Omega$
Contact resistance - centre contact - outer contact	4.4.2 4.4.3	$\leq 5 \text{ m}\Omega$ $\leq 1 \text{ m}\Omega$

MECHANICAL DATA	CECC 22000	REQUIREMENTS
Engagement force	4.5.4	max. 30 N / max. 6.7 lbs
Disengagement force	4.5.4	8 - 30 N / 1.8 - 6.7 lbs
Contact captivation	4.5.2	$\geq 10 \text{ N} / 2.3 \text{ lbs}$
Cable retention force	4.5.5	see pages 28 - 34
Durability (matings)	4.7.1	100

ENVIRONMENTAL DATA	CECC 22000 TEST CONDITIONS	EQUIVALENT MIL TEST CONDITIONS
Temperature range		- 55° C ... + 155° C / - 67° F ... + 311° F
Climatic category	→ 55 / 155 / 21	
Thermal shock	4.6.7 → IEC 68-2-14 Na	MIL-STD-202, Method 107 G, Condition B1
Moisture resistance	4.6.6 → IEC 68-2-3 Ca	MIL-STD-202, Method 106 F
Corrosion	4.6.10 → IEC 68-2-11 Ka	MIL-STD-202, Method 101, Condition B
Vibration	4.6.3 → IEC 68-2-6 Fc	MIL-STD-202, Method 204 D, Condition A

MATERIAL DATA		
CONNECTOR PARTS	MATERIAL	PLATING
Centre contact	copper-beryllium alloy	SUCOPRO /gold
Outer contact	copper-beryllium alloy	SUCOPRO
Body	brass	SUCOPRO
Crimp ferrules	E-copper	SUCOPRO/gold
Insulators	PTFE / PFA	

TECHNICAL DATA OF PCB CONNECTORS - BOARD-TO-BOARD

ELECTRICAL DATA	CECC 22000	REQUIREMENTS	REQUIREMENTS
		Nominal PCB distance 6.7 mm / .264 in.	Nominal PCB distance 11.7 mm / .461 in.
Impedance		50 Ω	
Frequency range		DC ... 12.4 GHz	
Dielectric withstanding voltage (at sea level)	4.4.5	1 kV rms, 50 Hz	
Working voltage (at sea level)	IEC 169-1 11.6.1	≤ 330 V rms, 50 Hz	
Insulation resistance	4.4.4	≥ 1 GΩ	
Contact resistance			
- centre contact	4.4.2	≤ 5 mΩ	
- outer contact	4.4.3	≤ 1 mΩ	

MECHANICAL DATA	CECC 22000	REQUIREMENTS	REQUIREMENTS
		6 SLOTS	4 SLOTS
Engagement force (Slideside)	4.5.4	< 15 N / 3.4 lbs	< 20 N / 4.5 lbs
Disengagement force (Slideside)	4.5.4	< 15 N / 3.4 lbs	< 20 N / 4.5 lbs
Contact captivation	4.5.2	10 N / 2.3 lbs	
Durability (matings)	4.7.1	100	

RETURN LOSS	REQUIREMENTS		
Nominal board-to-board distance	6.7 mm / .2638 in.	11.7 mm / .4606 in.	20.0 mm / .7874 in.
Typical return loss	board-to-board = two PCB-connector + one adaptor (without termination to PCB)		
- up to 2.5 GHz	26 dB	26 dB	26 dB
- 2.5 up to 6 GHz	25 dB	19 dB	19 dB

PROCESSING DATA	REQUIREMENTS
Adherent to the print	
- shearing	150 N / 33.7 lbs
- pulling (vertical to PCB)	150 N / 33.7 lbs

MATERIAL DATA		
CONNECTOR PARTS	MATERIAL	PLATING
Centre contact	brass	SUCOPRO / gold
Outer contact	bronze	SUCOPRO
Body	brass	SUCOPRO
Insulators	LCP / PTFE / PFA	

ENVIRONMENTAL DATA	CECC 22000 TEST CONDITIONS	EQUIVALENT MIL TEST CONDITIONS
Temperature range		- 55° C ... + 155° C / - 67 °F ... + 311 °F
Climatic category	→ 55 / 155 / 21	
Thermal shock	4.6.7 → IEC 68-2-14 Na	MIL-STD-202, Method 107 G, Condition B1
Moisture resistance	4.6.6 → IEC 68-2-3 Ca	MIL-STD-202, Method 106 F
Corrosion	4.6.10 → IEC 68-2-11 Ka	MIL-STD-202, Method 101, Condition B
Vibration	4.6.3 → IEC 68-2-6 Fc	MIL-STD-202, Method 204 D, Condition A

TECHNICAL DATA OF ADAPTORS BETWEEN SERIES

ELECTRICAL DATA	CECC 22000	REQUIREMENTS		
Impedance		50 Ω		
Frequency range		DC ... 12.4 GHz		
Typical return loss (mated pair)		DC – 2.5 GHz 32 dB	2.5 – 6 GHz 30 dB	6 – 12.4 GHz 16 dB
Dielectric withstanding voltage (at sea level)	4.4.5	1 kV rms, 50 Hz		
Working voltage (at sea level)	IEC 169-1 11.6.1	≤ 330 V rms, 50 Hz		
Insulation resistance	4.4.4	≥ 1 GΩ		
Contact resistance				
- centre contact	4.4.2	≤ 5 mΩ		
- outer contact	4.4.3	≤ 1 mΩ		

MECHANICAL DATA	CECC 22000	REQUIREMENTS
Engagement force (MMBX)	4.5.4	max. 30 N / max. 6.7 lbs
Disengagement force (MMBX)	4.5.4	8 - 30 N / 1.8 - 6.7 lbs
Durability (matings)	4.7.1	500

MATERIAL DATA		
CONNECTOR PARTS	MATERIAL	PLATING
MMBX centre contact	copper-beryllium alloy	SUCOPRO / gold
MMBX outer contact	brass / copper-beryllium	SUCOPRO
MMBX body	brass / copper-beryllium	SUCOPRO
MMBX insulators	LCP / PTFE / PFA	

ENVIRONMENTAL DATA	CECC 22000 TEST CONDITIONS	EQUIVALENT MIL TEST CONDITIONS
Temperature range		- 55° C ... + 155° C / - 67 °F ... + 311 °F
Climatic category	→ 55 / 155 / 21	
Thermal shock	4.6.7 → IEC 68-2-14 Na	MIL-STD-202, Method 107 G, Condition B1
Moisture resistance	4.6.6 → IEC 68-2-3 Ca	MIL-STD-202, Method 106 F
Corrosion	4.6.10 → IEC 68-2-11 Ka	MIL-STD-202, Method 101, Condition B
Vibration	4.6.3 → IEC 68-2-6 Fc	MIL-STD-202, Method 204 D, Condition A

Some connectors may have a specification that differs from the above mentioned data.

The products are designed and guaranteed to pass the above mentioned test procedures. Any additional or different requirement arising from specific applications or environmental conditions which is not covered by these test procedures is subject to request.

MMBX APPLICATION INSTRUCTION FOR PCB AND PANEL DISTANCES

The MMBX connector range offers a wide variety of interconnection solutions for blind mate PCB and panel applications. The formulas below provides a guideline to help to quickly determine; the board to board distance (x) for a combination of two board connectors and an adaptor, the minimum board to board or panel distance and the required adaptor length (a).

The parameters used in these formulas can be found on the MMBX connector outline drawings.

Example for board to board connection

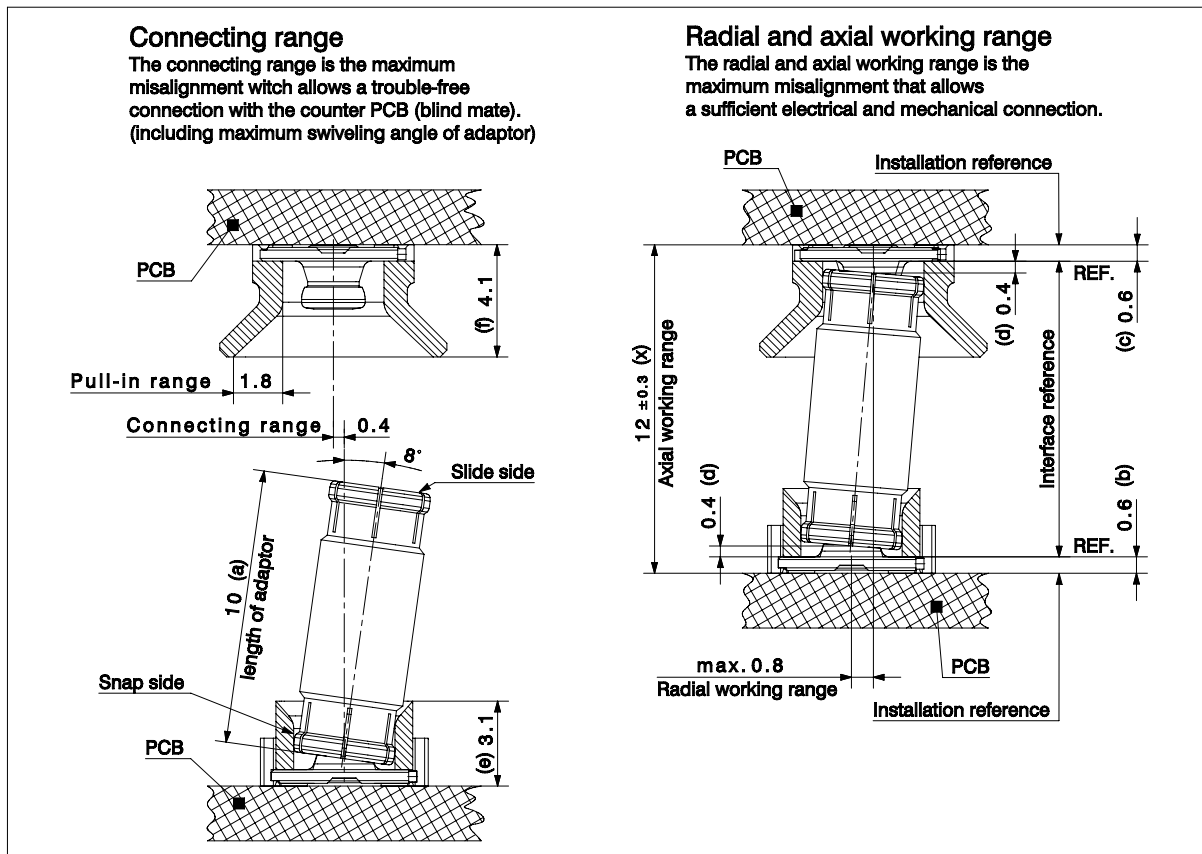

Formula

Distance $x = a + b + c + (2 * d)$
 Min. distance $x = e + f + 0.5\text{mm}$
 Adaptor length $a = x - b - c - (2 * d)$

Variables

x = Board to board distance
 a = adaptor length
 b = interface reference connector
 c = interface reference connector
 d = gap for adaptor movement
 e = height connector
 f = height connector

Calculation of example

Board to board distance $x = a + b + c + (2 * d) = 10\text{ mm} + 0.6\text{ mm} + 0.6\text{ mm} + (2 * 0.4\text{ mm}) = \underline{12\text{ mm}}$
 Min. board to board distance $x = e + f + 0.5\text{ mm} = 3.1\text{ mm} + 4.1\text{ mm} + 0.5\text{ mm} = \underline{7.7\text{ mm}}$
 Adaptor length $a = x - b - c - (2 * d) = 12\text{ mm} - 0.6\text{ mm} - 0.6\text{ mm} - (2 * 0.4\text{ mm}) = \underline{10\text{ mm}}$

Example for panel to panel connection

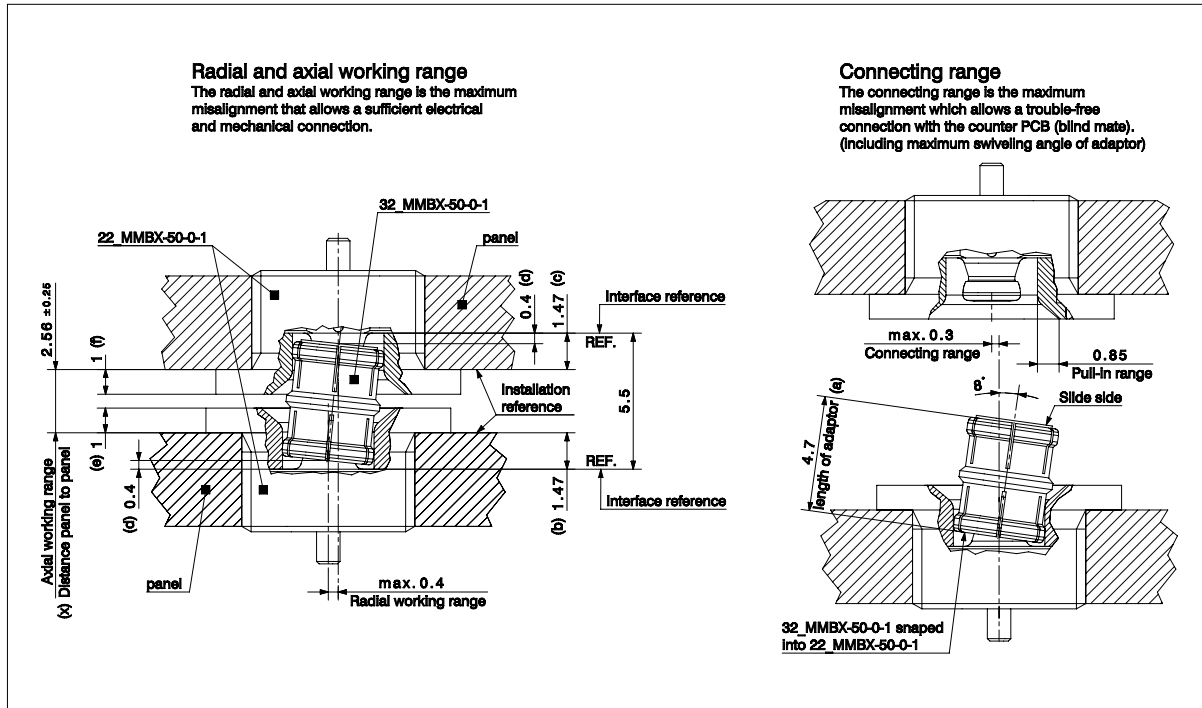

Note: For panel connectors the interface reference (b, c) needs to be subtracted.

Calculation of example

Panel to panel distance $x = a - b - c + (2 * d) = 4.7 \text{ mm} - 1.47 \text{ mm} - 1.47 \text{ mm} + (2 * 0.4 \text{ mm}) = \underline{2.56 \text{ mm}}$

Min. panel to panel distance $x = e + f + 0.5 \text{ mm} = 1 \text{ mm} + 1 \text{ mm} + 0.5 \text{ mm} = \underline{2.5 \text{ mm}}$

Adaptor length $a = x + b + c - (2 * d) = 2.56 \text{ mm} + 1.47 \text{ mm} + 1.47 \text{ mm} - (2 * 0.4 \text{ mm}) = \underline{4.7 \text{ mm}}$

CABLE CONNECTORS

Straight cable plugs (male)

- > for HUBER+SUHNER® MULTIFLEX
- > cable entry soldered
- > centre contact soldered

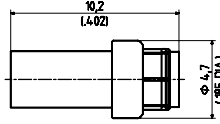

MMBX

HUBER+SUHNER type	Item no.	Cable group (example)	Packaging	Assembly instruction
11_MMBX-50-2-4/111_NE	84026769	Y11 (Multiflex 86)	single	27534
11_MMBX-50-2-4/111_NH	23033280	Y11 (Multiflex 86)	bulk 100 pcs.	27534

- > for flexible cables
- > HUBER+SUHNER® full crimp

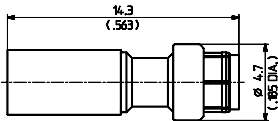

Fig. 1

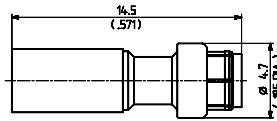

Fig. 2



HUBER+SUHNER type	Item no.	Cable group (example)	Packaging	Assembly instruction	Crimp insert	Fig.
11_MMBX-50-1-1/111_NE	23001743	U1 (EF 178)	single	27350	0.54 / A	1
11_MMBX-50-2-1/111_NE	23001745	U2 (EF 316)	single	27351	1 / A	2
11_MMBX-50-2-2/111_NE	23001744	U4 (EF 316 D)	single	27351	1 / A	2

Right angle cable plugs (male)

- > for microwave cables
- > cable entry soldered
- > centre contact soldered

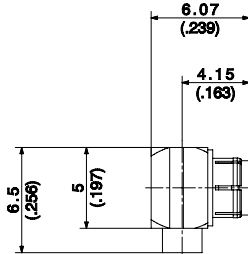

Fig. 1

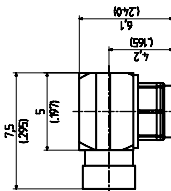

Fig. 2



HUBER+SUHNER type	Item no.	Cable group (example)	Packaging	Assembly instruction	Fig.
16_MMBX-50-1-2/111_NH	21000174	Y2 (EZ 47)	bulk 100 pcs.	0000247073	1
16_MMBX-50-2-4/111_NE	84026740	Y11 (Multiflex 86)	single	27533	2
16_MMBX-50-2-4/111_NH	23033281	Y11 (Multiflex 86)	bulk 100 pcs.	27533	2

Cable groups see page 28

Assembly tools see page 385

Mounting holes see page 412

- > for flexible cables
- > cable entry crimp
- > centre contact soldered

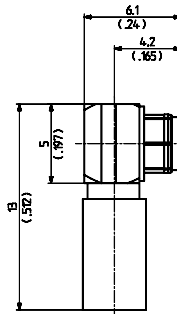

HUBER+SUHNER type	Item no.	Cable group (example)	Packaging	Assembly instruction	Crimp insert
16_MMBX-50-1-1/111_NE	23001748	U1 (EF 178)	single	27352	A
16_MMBX-50-2-1/111_NE	23001747	U2 (EF 316)	single	27352	A
16_MMBX-50-2-1/111_NH	84018554	U2 (EF 316)	bulk 100 pcs.	27352	A
16_MMBX-50-2-2/111_NE	23001746	U4 (EF 316 D)	single	27352	A
16_MMBX-50-2-2/111_NH	84028931	U4 (EF 316 D)	bulk 100 pcs.	27352	A

RECEPTACLES WITH SOLDER END

Receptacles, jacks (female)

- > bulkhead mounted

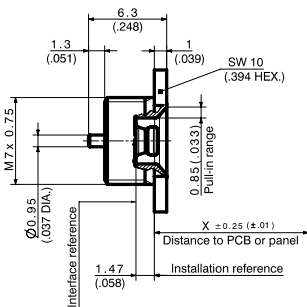

Fig. 1

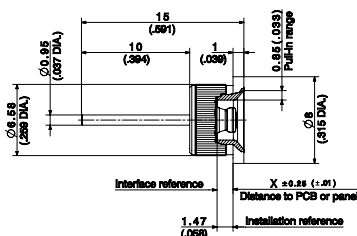

Fig. 2



HUBER+SUHNER type	Item no.	Packaging	Assembly style	Fig.
22_MMBX-50-0-1/111_NE	23008312	single	screwed-in	1
22_MMBX-50-0-2/111_NY	84005177	bulk 100 pcs.	pressed-in	2

PCB CONNECTORS

Straight PCB plugs (male)

> surface mount type SMT

MMBX

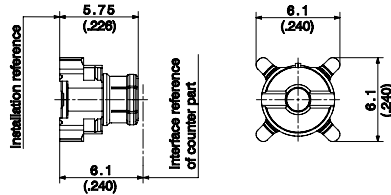

HUBER+SUHNER type	Item no.	Packaging	Soldering pad	Notes
81_MMBX-S50-0-1/111_NM	23001780	tape and reel	ML 122	
81_MMBX-S50-0-1/111_NH	23001781	bulk 100 pcs.	ML 122	
81_MMBX-S50-0-1/111_NE	23001782	single	ML 122	

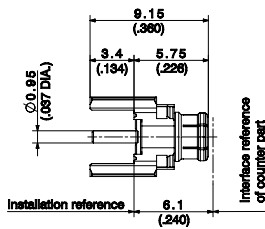

Fig. 1

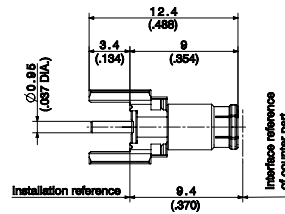

Fig. 2



HUBER+SUHNER type	Item no.	Packaging	Mounting hole	Notes	Fig.
81_MMBX-50-0-2/111_NM	23001776	tape and reel	ML 15		1
81_MMBX-50-0-2/111_NH	23001778	bulk 100 pcs.	ML 15		1
81_MMBX-50-0-2/111_NE	23001779	single	ML 15		1
81_MMBX-50-0-11/111_NM	23028072	tape and reel	ML 15		2

Straight PCB jacks (female)

> surface mount type SMT

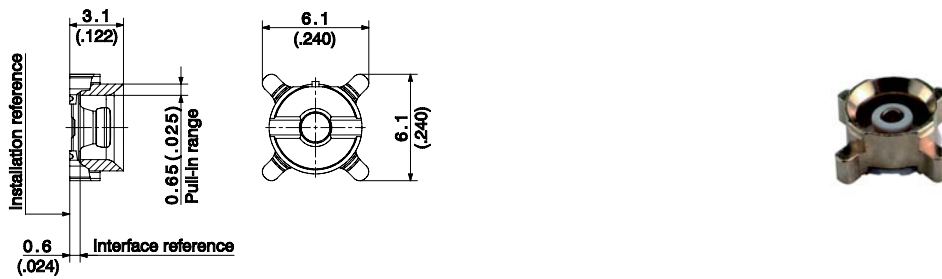

Fig. 1

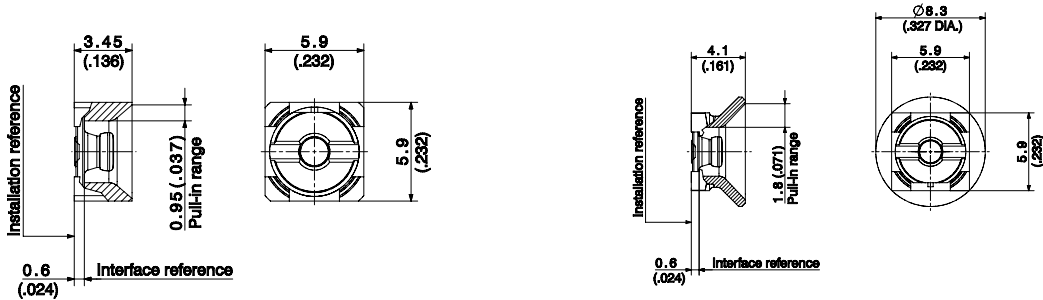

Fig. 2

Fig. 3

HUBER+SUHNER type	Item no.	Packaging	Soldering pad	Notes	Fig.
82_MMBX-S50-0-1/111_NM	23001783	tape and reel	ML 122	pull-in range 0.65 mm / .0256 in.	1
82_MMBX-S50-0-1/111_NH	23001784	bulk 100 pcs.	ML 122	pull-in range 0.65 mm / .0256 in.	1
82_MMBX-S50-0-1/111_NE	23001785	single	ML 122	pull-in range 0.65 mm / .0256 in.	1
82_MMBX-S50-0-3/111_NM	23031931	tape and reel	ML 122	pull-in range 0.95 mm / .0374 in.	2
82_MMBX-S50-0-3/111_NH	23011273	bulk 100 pcs.	ML 122	pull-in range 0.95 mm / .0374 in.	2
82_MMBX-S50-0-3/111_NE	23015527	single	ML 122	pull-in range 0.95 mm / .0374 in.	2
82_MMBX-S50-0-13/111_NM	23041511	tape and reel	ML 122	pull-in range 1.80 mm / .0709 in.	3
82_MMBX-S50-0-13/111_NH	23036608	bulk 100 pcs.	ML 122	pull-in range 1.80 mm / .0709 in.	3
82_MMBX-S50-0-13/111_NE	84032435	single	ML 122	pull-in range 1.80 mm / .0709 in.	3

Straight PCB jacks (female)

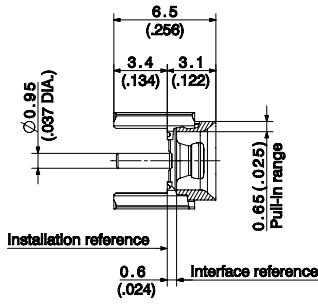

Fig. 1



MMBX

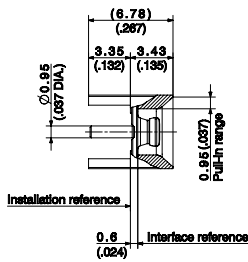

Fig. 2

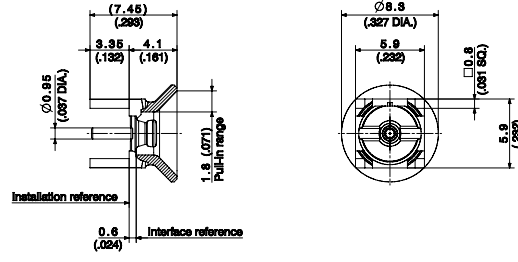
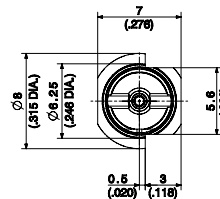
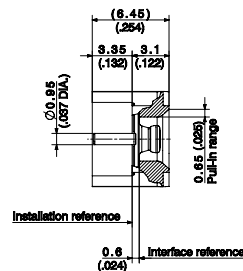

Fig. 3

HUBER+SUHNER type	Item no.	Packaging	Mounting hole	Notes	Fig.
82_MMBX-50-0-2/111_NM	23001786	tape and reel	ML 15	pull-in range 0.65 mm / .0256 in.	1
82_MMBX-50-0-2/111_NH	23001787	bulk 100 pcs.	ML 15	pull-in range 0.65 mm / .0256 in.	1
82_MMBX-50-0-2/111_NE	23001788	single	ML 15	pull-in range 0.65 mm / .0256 in.	1
82_MMBX-50-0-4/111_NH	23013667	bulk 100 pcs.	ML 15	pull-in range 0.95 mm / .0374 in.	2
82_MMBX-50-0-14/111_NH	23038051	bulk 100 pcs.	ML 15	pull-in range 1.80 mm / .0709 in.	3
82_MMBX-50-0-14/111_NE	84032421	single	ML 15	pull-in range 1.80 mm / .0709 in.	3

Straight PCB jacks (female), edge-mount



HUBER+SUHNER type	Item no.	Packaging	Mounting hole	Notes
92_MMBX-S50-0-12/111_NM	23038620	tape and reel	ML 147	
92_MMBX-S50-0-12/111_NE	84019159	single	ML 147	

ADAPTORS WITHIN-SERIES

Straight adaptors

> plug to plug (male)

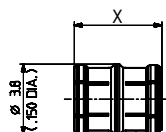

HUBER+SUHNER type	Item no.	Packaging	Board-to-board distance	Adaptor length X	Min. pull-in range
32_MMBX-50-0-1/111_NE	23001749	single	6.7 mm/.264 in.	4.7 mm/.158 in.	0.65 mm/.026 in.
32_MMBX-50-0-1/111_NY	84028418	industrial 200 pcs.	6.7 mm/.264 in.	4.7 mm/.158 in.	0.65 mm/.026 in.
32_MMBX-50-0-12/111_NH	84004734	industrial 100 pcs.	8.0 mm/.315 in.	6.0 mm/.236 in.	0.95 mm/.037 in.
32_MMBX-50-0-11/111_NE	23040373	single	9.0 mm/.354 in.	7.0 mm/.276 in.	0.95 mm/.037 in.
32_MMBX-50-0-4/111_NE	23010564	single	10.0 mm/.394 in.	8.0 mm/.315 in.	1.80 mm/.071 in.
32_MMBX-50-0-4/111_NY	23038658	industrial 300 pcs.	10.0 mm/.394 in.	8.0 mm/.315 in.	1.80 mm/.071 in.
32_MMBX-50-0-8/111_NE	23030066	single	11.65 mm/.459 in.	9.65 mm/.380 in.	1.80 mm/.071 in.
32_MMBX-50-0-13/111_NE	84031096	single	12.0 mm/.472 in.	10.0 mm/.417 in.	1.80 mm/.071 in.
32_MMBX-50-0-5/111_NE	84026915	single	14.0 mm/.551 in.	12.0 mm/.472 in.	1.80 mm/.071 in.
32_MMBX-50-0-5/111_NY	23011920	industrial 200 pcs.	14.0 mm/.551 in.	12.0 mm/.472 in.	1.80 mm/.071 in.
32_MMBX-50-0-10/111_NY	23034946	industrial 200 pcs.	15.0 mm/.591 in.	13.0 mm/.512 in.	1.80 mm/.071 in.
32_MMBX-50-0-6/111_NE	23022532	single	16.5 mm/.650 in.	14.5 mm/.571 in.	external guidance needed
32_MMBX-50-0-6/111_NH	84024341	industrial 100 pcs.	16.5 mm/.650 in.	14.5 mm/.571 in.	external guidance needed
32_MMBX-50-0-9/111_NH	23033418	industrial 100 pcs.	18.0 mm/.709 in.	16.0 mm/.630 in.	external guidance needed
32_MMBX-50-0-3/111_NE	23023073	single	20.0 mm/.787 in.	18.0 mm/.709 in.	external guidance needed
32_MMBX-50-0-15/111_NY	84033819	industrial 100 pcs.	21.2 mm/.835 in.	19.2 mm/.755 in.	external guidance needed
32_MMBX-50-0-14/111_NY	84010338	industrial 100 pcs.	32.7 mm/1.287 in.	30.7 mm/1.207 in.	external guidance needed

TOOLS

Adaptor assembly and disassembly tool



Fig. 1



Fig. 2

HUBER+SUHNER type	Item no.	Packaging	Operating instruction	Fig.
74_Z-0-0-437	23023494	single	27378	1
74_Z-0-0-557	84032418	single	0000246815	2