

The Micro Line - .050" Contact Spacing



The Cannon MICRO Series established the standards for performance and reliability in miniature interconnects. Exceptionally versatile, MICRO connectors are available in rectangular, circular, and strip configurations, with 3 amp MICROPIN™/MICROSOCKET™ contacts on .050(1.27) centers, or with special arrangements of power and coaxial contacts.

The heart of the Cannon MICROPIN/MICROSOCKET contact system is a multi-element Twist Pin Contact recessed with an insulating housing. The rugged, cylindrical sockets are mounted in the exposed half of the connector. When connector

halves are mated, the chamfered sockets are first aligned by the connector body, then guide the spiral MICROPIN contacts into proper and positive alignment, even under worst-case tolerance conditions. This is Cannon's POS-A-LINE connectors design.

The multiple spring elements of the MICROPIN, then under compression, form a multi-point contact system of high mechanical and electrical integrity. Contacts will provide a high degree of reliability over hundreds of mating and unmating cycles, and have proven themselves in applications that range from commercial products to equipment that has been landed on the moon.

- Contact rating - 3 amps max.
- Contact centers - .050(1.27).
- Wire sizes - #24 thru #32 AWG, stranded or solid.
- Contact termination - multiple indent crimp.
- Contact retention - fixed via epoxy.
- Contact materials and finish - Copper alloy, gold-plated per MIL-G-45204, Type II, Grade C, Class 1 over copper flash.
- Mating/unmating force - 8 oz. per contact, max./0.5 oz. per contact min.

Test Data

The table below summarizes the results of key tests performed in accordance with MIL-STD-1344, where applicable. Data is applicable to standard connectors with standard termination. Variations may affect this data, so please consult the factory for further information on your requirements.

Test	Method	Criteria of Acceptance
Dielectric Withstanding Voltage	Method 3001:	
	900 VAC at sea level	No breakdown
	300 VAC at 70,00' altitude	No breakdown
	Solder Pots and Shielded Cable 600 VAC at sea level 150 VAC at 70,000' altitude	No breakdown No breakdown
Insulation Resistance	Method 3003	5,000 megohms minimum
Thermal Shock	Method 1003, Condition A: - 55°C to +125°C	No physical damage
Physical Shock	Method 2004, Condition E: 50 G's, 3 axes, 6 millisecond duration sawtooth pulse	No physical damage No loss of continuity > 1 µsec
Vibration	Method 2005, Condition IV: 20 G's, 10-2,000 Hz. 12 hrs	No physical damage No loss of continuity > 1 µsec
Durability	500 cycles of mating and unmating, 500 CPH max.	No mechanical or electrical defects
Moisture Resistance	Method 1002, Type II omit steps 7a & 7B	Insulation resistance > 100 megohms
Salt Spray	Method 1001, Condition B: 48 hours	Shall be capable of mating and unmating, and meet contact resistance requirements
Contact Resistance (MIL-STD-202)	Method 307 At 3 amps At 1 milliamps	8 milliohms maximum 10 milliohms maximum
Contact Retention	Per MIL-C-83513	5 lb. minimum axial load

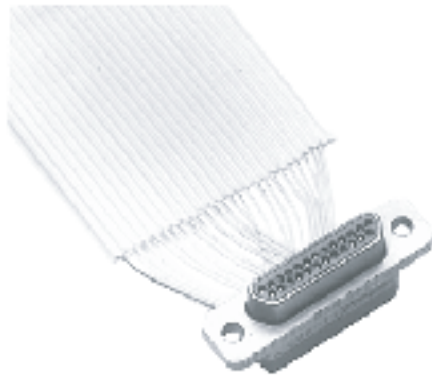

MDM connectors are used in applications requiring highly reliable, extremely small, lightweight connectors with higher density contact configurations than available in traditional rectangular connectors. They are available in 8 shell sizes accommodating from 9 to 100 contacts, and special arrangements of power and coaxial contacts.

These connectors are designed to meet the rapidly increasing demands for an environmental, high performance, rugged, moisture-sealed microminiature connector. This connector employs size 24 MICRO-

PIN[®]/MICROSOCKET[®] contacts on .050(1.27_ centers in a contact density identical to the standard MICRO-D connector series, but with these additional features:

¥ Aluminum shells to provide greater strength, prevent chipping, cracking or breaking, offer electromagnetic (EMI) and RFI shielding.

¥ Silicone elastomer compression interfacial seal to provide a moisture and humidity seal between each contact and between contacts and shell.

How to Order

MIL-C-83513 ordering information- pages 240 and 241



SERIES

MDM (size 9-100): Liquid Crystal Ploymer (LCP)
MDM (Combo Layout): Diallyl Phthalate insulator
Material

CONTACT ARRANGEMENTS

9-15-21-25-31-37-51-100 (standard)
7C2, 24C42 (coaxial) } or combination of
7P2, 24P4 (power) } coax and power

CONTACT TYPE

P - Pin
S - Socket

TERMINATION TYPE

H - Harness-insulated wire.
L - Solid-uninsulated wire.
S - Solder pot to accept #26 AWG MAX.
harness wire. (Not available with power
contact arrangements.)

TERMINATION CODE*

(H) 001 - 18", 7/34 strand, #26 AWG,
MIL-W-16878/4, Type E Teflon,
yellow.
(H) 003 - 18", 7/34 strand, #26 AWG,
MIL-W-16878/4, Type E Teflon,
color coded to MIL-STD-681
System I.
(L) 1 - 1/2" uninsulated solid #25
AWG gold plated copper.
(L) 2 - 1" uninsulated solid #25 AWG
gold plated copper.

HARDWARE

M - Military specification hardware, see
page 237.
P - Jackpost
K - Jackscrew-standard
L - Jackscrew-low profile

F - Float mount

B - No hardware standard
.091 (2.31) dia. hole for sizes 9-51;
.120 (3.05) dia. hole for size 100.
A - .125 (3.18) dia. mounting holes fo
sizes 9-51;
.166 (4.22) dia. hole for size 100.
B1 - .1475 (3.75) dia. hole for size 100
(Per MIL-C-83513)

SHELL FINISH MOD CODES**

No
Number - Standard Cadmium/yellow chromate
A174 - Electroless nickel
A172 - Gold over nickel
A141 - Iridite/alodine
A30 - Black anodize

*See Termination Codes page 233 for additional length
Modification codes.

**For other modifications not listed, consult the factory.

Performance and Material Specifications

STANDARD MATERIALS AND FINISHES

Shell	- Aluminum alloy per QQ-A-200/8 (6061-T6), yellow chromate/cadmium per QQ-P-416, Type II, class 3.
Insulator	- MIL-M-24519, Type GLCP-30F Glass-filled diallyl phthalate per MIL-M-14, Type SDGF
Contacts	- Copper alloy, gold plate
Mounting Hardware	- 300 Series stainless steel, passivate
Kit, Jackpost (3) items	- 300 Series stainless steel, passivate
Washer	- 400 Series stainless steel, passivate
Standard Epoxy	- Hysol EE4198 with HD3561 hardener, color green or EE4215 with HD3561, color black

MECHANICAL FEATURES

Coupling	- Friction/jackscrews
Polarization	- Keystone-shaped shells
Contact Spacing	- .050 (1.27)
Centers	
Shell Styles	- Plug and receptacle
No. of Contacts	- 9 thru 100 standard; 5 signal/2 coaxial; 5 signal/2 power. 20 signal/4 coaxial; 20 signal/4 power
Coaxial Cable	- RG - 178/U
Wire Size	- #24 thru #32 AWG
Contact Termination	- Multiple indent crimp

ELECTRICAL DATA - page 231

Standard Wire Termination Codes

Cannon Modification Code (Not MS)

The following termination codes are listed for your information. For lengths not shown, consult factory for proper modification code. All wire lengths are minimum.

Harness TYPE (H)

#26 AWG per MIL-W-16878/4, 7/34 strand, type E Teflon, stranded.

Length	All Yellow	Color Coded*
3 (76.2)	H020	H027
6 (152.4)	H019	H016
8 (203.2)	H026	H034
10 (254.0)	H029	H025
12 (304.8)	H028	H002
18 (457.2)	H001	H003
20 (508.0)	H038	H023
24 (609.6)	H009	H004
30 (762.0)	H010	H005
36 (914.4)	H011	H006
48 (1219.2)	H013	H048
72 (1828.8)	H017	H046
120 (3048.0)	H042	H041

* Cavity #1 black

Solid Uninsulated Type (L)

#25 AWG gold plated copper

Termination Code	Length
L61	.125 (3.18)
L56	.150 (3.81)
L57	.190 (4.83)
L39	.250 (6.35)
L58	.375 (9.52)
L1	.500 (12.70)
L14	.750 (19.05)
L2	1.000 (25.40)
L7	1.500 (38.10)
L6	2.000 (50.80)
L16	2.500 (63.50)
L10	3.000 (76.20)

Milimeters are in parentheses.

Contact Arrangements

(Face View of Pin insert - Use Reverse Order for Socket Side)

Standard

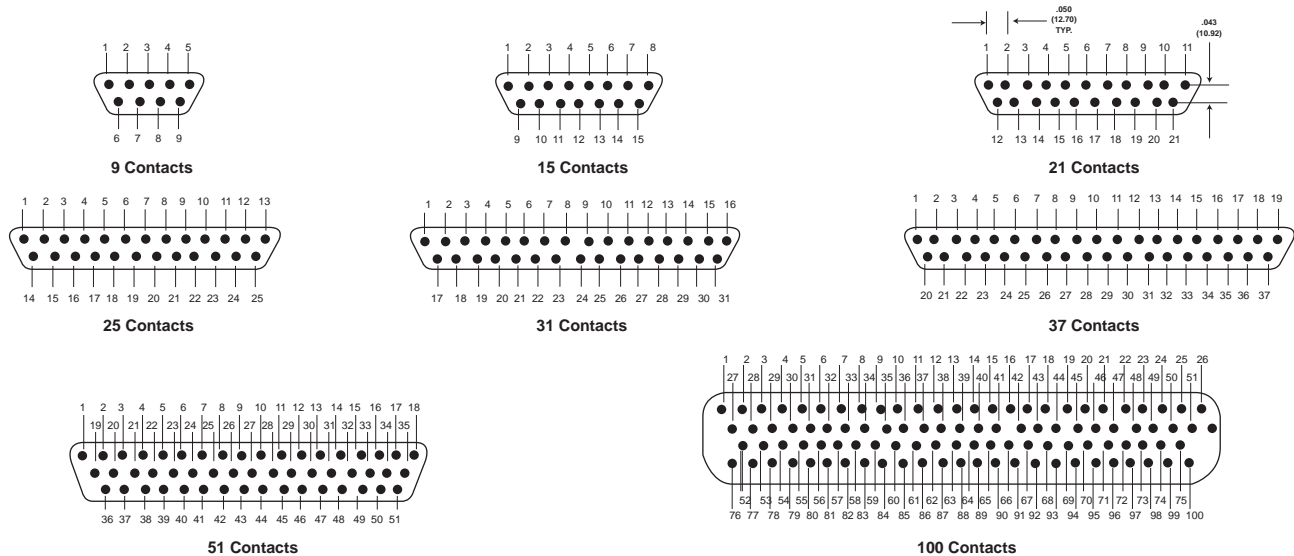

Contact identification numbers are for reference only and do not appear on insulator or connector body.

Coaxial



Shell Dimensions (Conforms to MIL-C-83513)

Plug

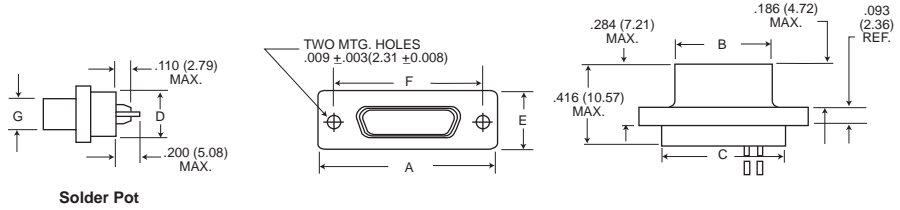

Receptacle

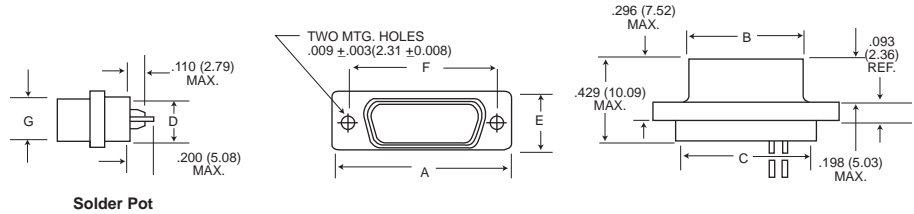

Receptacle (MDM-100 only)

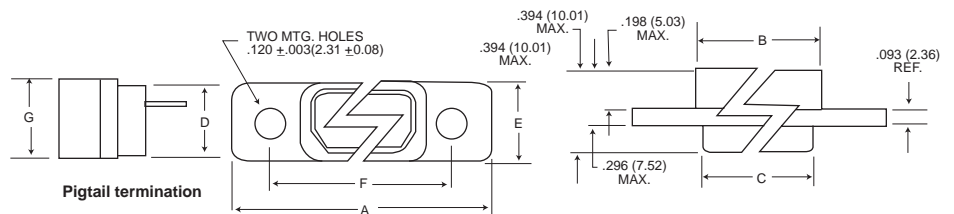

Part Number By Shell Size	A Max.	B Max.	C Max.	D Max.	E Max.	F ±.005 (0.13)	G Max.	Average Weights** oz. (gm.) ±5%
MDM-9P*	.785 (19.94)	.334 (8.48)	.400 (10.16)	.270 (6.86)	.308 (7.82)	.565 (14.35)	.185 (4.70)	.063 (1.79)
MDM-9S*	.785 (19.94)	.402 (10.21)	.400 (10.16)	.270 (6.86)	.308 (7.82)	.565 (14.35)	.253 (6.43)	.063 (1.79)
MDM-15P*	.935 (23.75)	.484 (12.29)	.550 (13.97)	.270 (6.86)	.308 (7.82)	.715 (18.16)	.185 (4.70)	.084 (2.39)
MDM-15S*	.935 (23.75)	.552 (13.97)	.550 (13.97)	.270 (6.86)	.308 (7.82)	.715 (18.16)	.253 (6.43)	.083 (2.37)
MDM-21P*	1.085 (27.56)	.634 (16.10)	.700 (17.78)	.270 (6.86)	.308 (7.82)	.865 (21.97)	.185 (4.70)	.105 (2.99)
MDM-21P*	1.085 (27.56)	.702 (17.83)	.700 (17.78)	.270 (6.86)	.308 (7.82)	.865 (21.97)	.253 (6.43)	.104 (2.97)
MDM-25P*	1.185 (30.10)	.734 (18.64)	.800 (20.32)	.270 (6.86)	.308 (7.82)	.965 (24.51)	.185 (4.70)	.119 (3.39)
MDM-25S*	1.185 (30.10)	.802 (20.37)	.800 (20.32)	.270 (6.86)	.308 (7.82)	.965 (24.51)	.253 (6.43)	.118 (3.36)
MDM-31P*	1.335 (33.91)	.884 (22.45)	.950 (24.13)	.270 (6.86)	.308 (7.82)	1.115 (28.32)	.185 (4.70)	.140 (3.99)
MDM-31S*	1.335 (33.91)	.952 (24.18)	.950 (24.13)	.270 (6.86)	.308 (7.82)	1.115 (28.32)	.253 (6.43)	.139 (3.96)
MDM-37P*	1.485 (37.72)	1.034 (26.26)	1.100 (27.94)	.270 (6.86)	.308 (7.82)	1.265 (32.13)	.185 (4.70)	.161 (4.59)
MDM-37S*	1.485 (37.72)	1.102 (27.99)	1.100 (27.94)	.270 (6.86)	.308 (7.82)	1.265 (32.13)	.253 (6.43)	.160 (4.56)
MDM-51P*	1.435 (36.45)	.984 (24.99)	1.050 (26.67)	.310 (7.87)	.351 (8.92)	1.215 (30.86)	.228 (5.79)	.193 (5.50)
MDM-51S*	1.435 (36.45)	1.052 (26.72)	1.050 (26.67)	.310 (7.87)	.351 (8.92)	1.215 (30.86)	.296 (7.52)	.188 (5.35)
MDM-100P*	2.170 (55.12)	1.384 (35.15)	1.442 (36.63)	.360 (9.14)	.394 (10.01)	1.800 (45.72)	.271 (6.88)	.500 (14.3)
MDM-100S*	2.170 (55.12)	1.508 (38.10)	1.442 (36.63)	.360 (9.14)	.394 (10.01)	1.800 (45.72)	.394 (10.01)	1.040 (29.5)

*Add lead type and length; see How To Order.

***Weight given is 1/2", uninsulated, solid, #25 AWG gold plated copper pigtailed.

Panel Mounting Dimensions (Sizes 9 - 100)

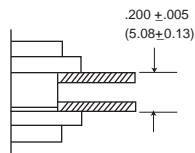

**Plug and Receptacle
Rear Mounted**

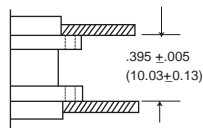

**Plug and Receptacle
Front Mounted**

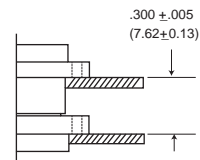

**Plug Front Mounted
Receptacle Rear Mounted**

Panel Cutouts

NOTE: See page 237 for rear panel mounting configuration.

Shell Sizes 9 thru 51

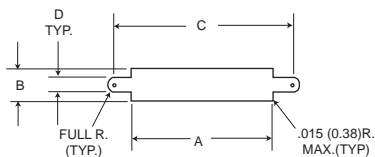

Figure 1
Front Mounting

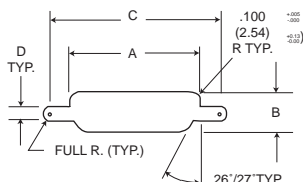

Figure 2
Rear Mounting

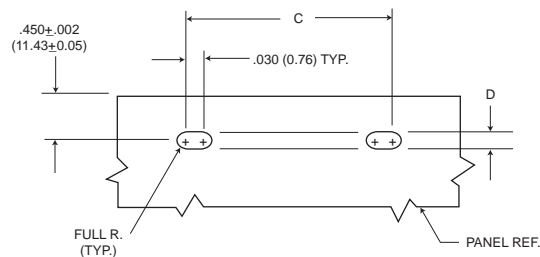

Figure 3
Edgeboard Mounting

Shell Size 100

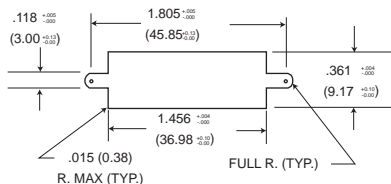

Figure 1
Front Mounting

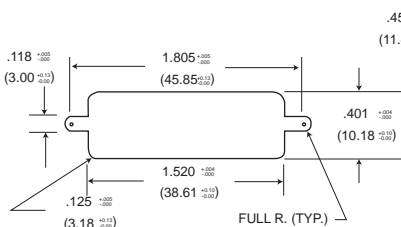

Figure 2
Rear Mounting

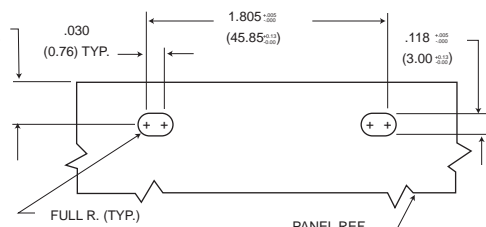

Figure 3
Edgeboard Mounting

For 9-51 Shell Sizes

NOTES:

1. Front mounting (figure 1) and rear mounting (figure 2) accommodates #2-56 screws
2. Front mounting is preferred. However, when rear mounting is necessary, use figure 2 dimensions when jackscrews are used. See detail on page 24 when jackpost are used.
3. Edgeboard mounting bracket (figure 3) uses #2-56 screws. Dimension $.450 \pm .002$ (11.43±0.05) locates the MDM receptacle flush with the end of the board.

For 100 Shell Size

NOTES:

1. Front mounting (figure 1) and rear mounting (figure 2) accommodates #4-40 screws.
2. Edgeboard mounting bracket (figure 3) uses #4-40 screws. Dimension $.450 \pm .002$ (11.43±0.05) locates the MDM receptacle flush with the end of the board.
3. Front mounting is preferred. However, when rear mounting is necessary, use figure 2 dimensions.

Shell Size	Cutout Figure	A	B	C	D
		+0.004 (0.10) -0.000 (0.00)	+0.004 (0.10) -0.000 (0.00)	+0.005 (0.13) -0.000 (0.00)	+0.005 (0.13) -0.000 (0.00)
9	1	.408 (10.36)	.271 (6.88)	.570 (14.48)	.089 (2.26)
	2	.401 (10.19)	.252 (6.40)	.570 (14.48)	.089 (2.26)
	3	-	-	.570 (14.48)	.089 (2.26)
15	1	.558 (14.17)	.271 (6.88)	.720 (18.29)	.089 (2.26)
	2	.551 (14.00)	.252 (6.40)	.720 (18.29)	.089 (2.26)
	3	-	-	.720 (18.29)	.089 (2.26)
21	1	.708 (17.98)	.271 (6.88)	.870 (22.10)	.089 (2.26)
	2	.701 (17.81)	.252 (6.40)	.870 (22.10)	.089 (2.26)
	3	-	-	.870 (22.10)	.089 (2.26)
25	1	.808 (20.52)	.271 (6.88)	.970 (24.64)	.089 (2.26)
	2	.801 (20.34)	.252 (6.40)	.970 (24.64)	.089 (2.26)
	3	-	-	.970 (24.64)	.089 (2.26)
31	1	.958 (24.33)	.271 (6.88)	1.120 (28.45)	.089 (2.26)
	2	.951 (24.16)	.252 (6.40)	1.120 (28.45)	.089 (2.26)
	3	-	-	1.120 (28.48)	.089 (2.26)
37	1	1.108 (28.14)	.271 (6.88)	1.270 (32.26)	.089 (2.26)
	2	1.101 (27.97)	.252 (6.40)	1.270 (32.26)	.089 (2.26)
	3	-	-	1.270 (32.26)	.089 (2.26)
51	1	1.058 (26.87)	.315 (8.00)	1.220 (30.99)	.089 (2.26)
	2	1.051 (26.70)	.295 (7.49)	1.220 (30.99)	.089 (2.26)
	3	-	-	1.220 (30.99)	.089 (2.26)

Mounting Hardware Views (for sizes 9-51)

This hardware supplied unassembled.



Screw Lock Assembly



90° Angle Mounting Bracket

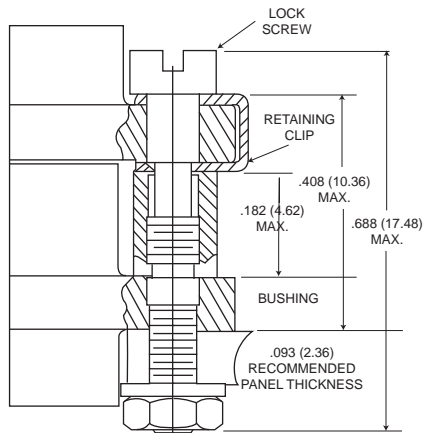

Screw Lock Assembly*

*NOTE Torque value is 2.5 in/lbs max.

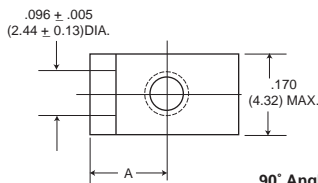

90° Angle Mounting Bracket

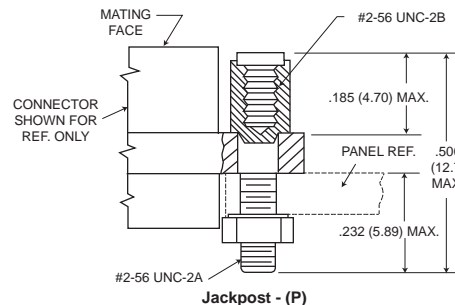

Jackpost - (P)

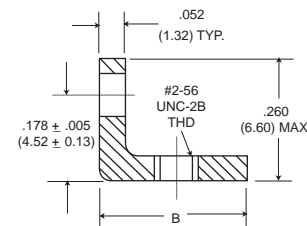

Description	Part Number	A ±.005 (±0.13)	B Max.
Screw Lock Assembly	322-9500-000		N/A
Jackpost kit	320-9505-000		N/A
Mounting Bracket 90° MDM for 9 thru 37 Shell Sizes	015-9516-002	.147 (3.73)	.308 (7.82)
Mounting Bracket 90° MDM for 51 Shell Size	015-9516-003	.169 (4.29)	.350 (8.89)

NOTES: Screw lock assembly (322-9500-000) can be used for front mounting only. Jackpost kit (320-9505-000) consists of two assemblies, shipped unassembled.

Jackpost Bushing (for rear panel mounting-for sizes 9-51)

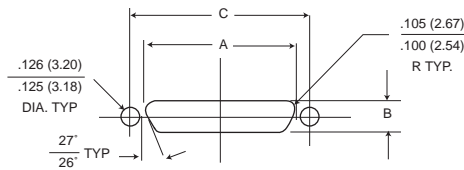
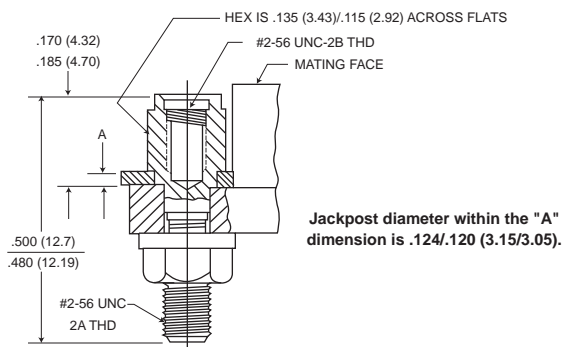

Plug and Rectacle Dimensions

Shell Size	A +.004 (0.10) -.000 (0.00)	B +.004 (0.10) -.000 (0.00)	C ±.005 (0.13)
9	.401 (10.19)	.252 (6.40)	.565 (14.35)
15	.551 (14.00)	.252 (6.40)	.715 (18.16)
21	.701 (17.81)	.252 (6.40)	.865 (21.97)
25	.801 (20.34)	.252 (6.40)	.965 (24.51)
31	.951 (24.16)	.252 (6.40)	1.115 (28.34)
37	1.101 (27.97)	.252 (6.40)	1.265 (32.13)
51	1.051 (26.70)	.295 (7.49)	1.215 (30.86)

Panel A Thickness	A +.005 (0.13) -.000 (0.00)	Jackpost Kit Number*
3/32 (2.4)	.087 (2.21)	320-9505-007
1/16 (1.6)	.056 (1.42)	320-9505-006
3/64 (1.2)	.042 (1.07)	320-9505-005
1/32 (0.8)	.025 (0.64)	320-9505-004

*A kit consists of 2 jackpost, 2 nuts, 2 washers.

Mounting Hardware Views (sizes 9-51)

This hardware is factory installed.

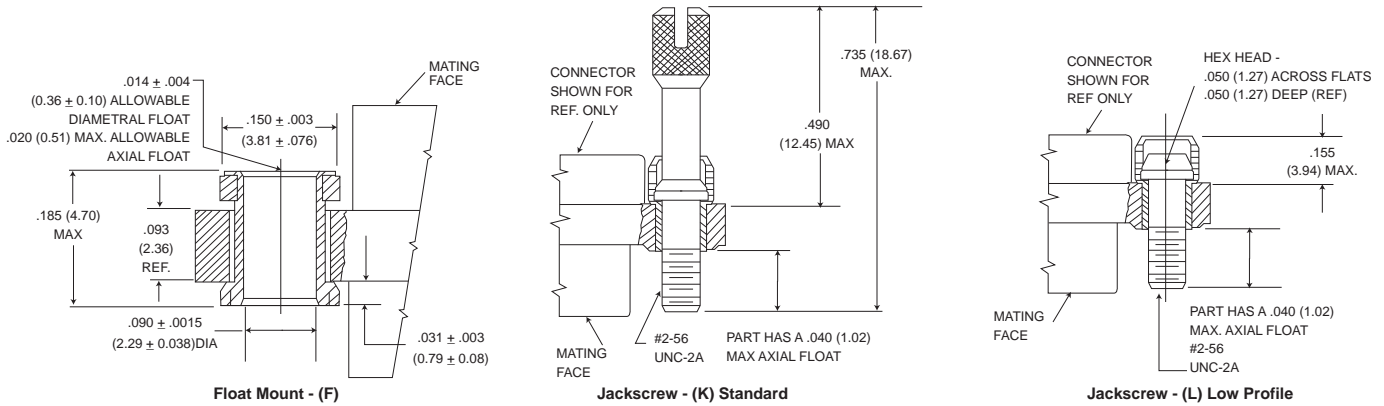

Shown here is a cutaway view of the float mount for the MD connector. The basic shell dimensions are the same for the float mount and the screw mounting hole configurations. View shown is for standard float mount front panel mounting. Reverse mounting is available on request.

* NOTE: Torque vales are as follows:
 Low Profile Jackscrew (L)-2.5 in/lbs
 Standard Jackscrew (K)-2.5 in/lbs

Repair kit available-consult factory.

Mounting Hardware to Military Specification (for sizes 9 - 100) per MIL-C-83513/5

This hardware supplied in kits unassembled (2 pieces of each item).

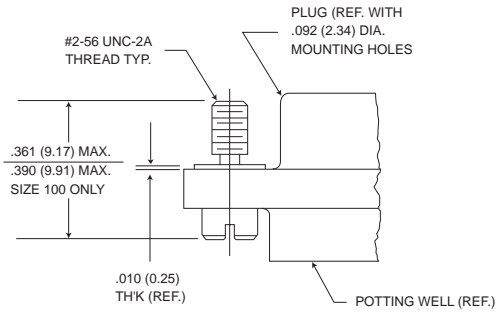
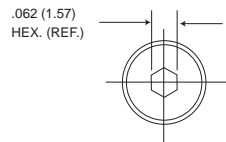

Figure 1. Jackscrew - Low profile Slotted Head Size 9-51 Size 100*



Allen head Optional Head Configuration Plug and Receptacle Low and High Profile Size 9-51 Size 100* (same dimensions)

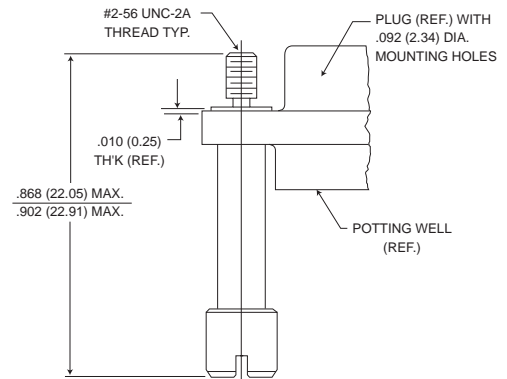

Figure 2. Jackscrew - High Profile Slotted Head Size 9-51 Size 100*

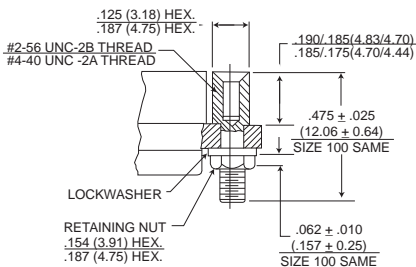

Figure 3. Jackpost Assembly Size 9-51 Size 100*

To order hardware kits separately, order either by M83513/5-** or by 320-950X-XXX.

Description	Size 9-51		Size 100*	
	Mod Code	Part Number	Mod Code	Part Number
Slotted Head Jackscrew Assy Low Profile (Figure 1)	M5	320-9508-025	05	M15 320-9508-021
Slotted Head Jackscrew Assy Low Profile (Figure 2)	M6	320-9508-027	06	M16 320-9508-023
Allen Head Jackscrew Assy Low Profile (Figure 1)	M2	320-9508-026	02	M12 320-9508-022
Allen Head Jackscrew Assy High Profile (Figure 2)	M3	320-9508-028	03	M13 320-9508-024
Jackpost Assy (Figure 3)	M7	320-9505-033	07	M17 320-9505-030

*Size 100 requires B1 size mounting holes.

Mounting Hardware Views (for size 100)

This hardware supplied unassembled.



90° Angle Mounting Bracket

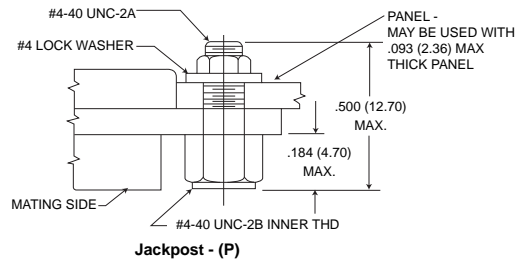

Jackpost - (P)

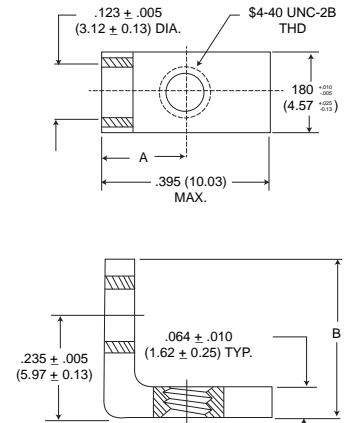

90° Angle Mounting Bracket

Description	Part Number	A ± .005 (0.13)	B Max.
Jackpost kit	320-9505-015	N/A	
Mounting Bracket 90° MDM	015-9528-000	.191 (4.85)	.370 (9.40)

This hardware is factory installed.

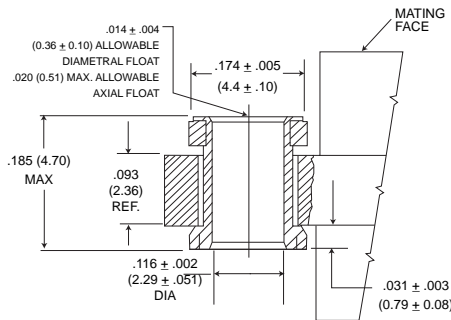

Float Mount - (F) Std.

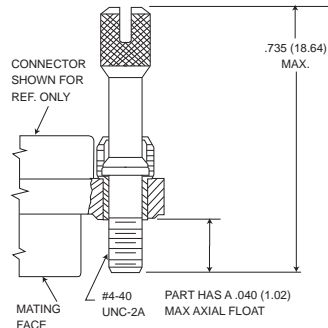

Jackscrew - (K) Standard

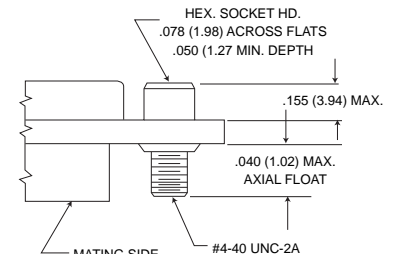

Jackscrew - (L) (Low Profile)

*NOTE: Torque vales are as follows:
 Low Profile Jackscrew (L)-4.0 in/lbs
 Standard Jackscrew (K)-4.0 in/lbs

Jackpost Bushing (for Rear Panel Mounting)

Panel Thickness	A + .005 (0.13) - .000 (0.00)	Jackpost Kit Number*
3/32 (2.4)	.087 (2.21)	320-9505-013
1/16 (1.6)	.058 (1.42)	320-9505-012
1/32 (0.8)	.025 (0.64)	320-9505-010
3/64 (1.2)	.042 (1.07)	320-9505-011

*2 jackposts, 2 nuts, 2 washers

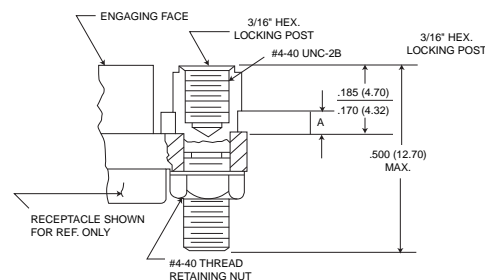

Dimensions for Rear Panel Mounting

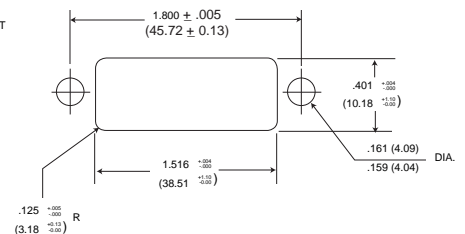

Connector Saver

Save wear and tear on your equipment and systems connectors by using the "Connector Saver".

The multi-matings and unmatings experienced by most connectors during testing and final check out can be eliminated.

Simply mate the "Connectors Saver" to your unit and use the opposite side for your testing interface... less wear, less tear, less chance of damage. It is available in all seven standard MDM layouts. Mating hardware is available and can be ordered either separately or included with the connector saver.

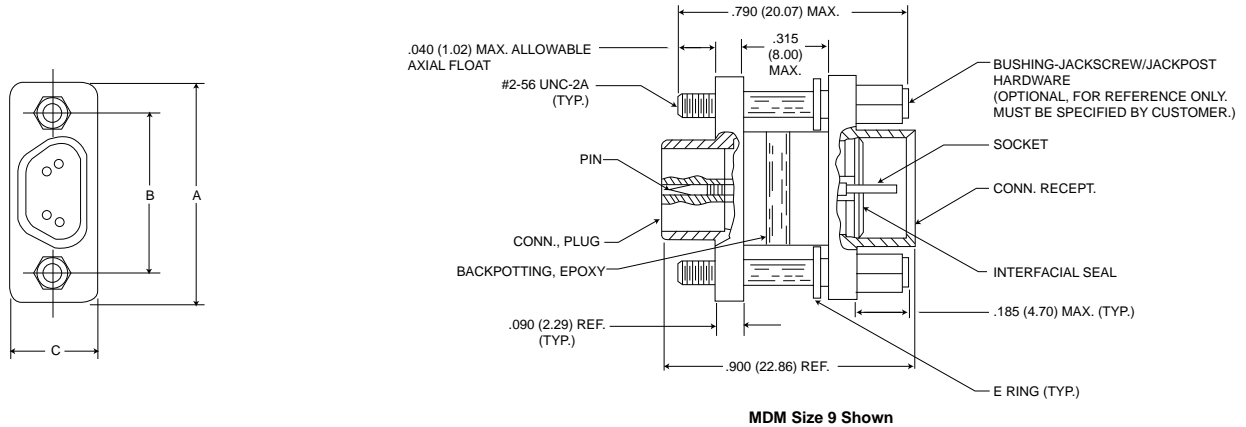

Size	A174 Electroless Nickel		Cadmium Plated		*Hardware Kits	A Max.	B ± .005 (0.13)	C Max.
	With Hardware	W/O Hardware	With Hardware	W/O Hardware				
9	MDM98479-86	MDM98479-18	MDM98479-78	MDM-97294-371	320-9505-014**	.785 (19.94)	.565 (14.35)	.308 (7.82)
15	MDM98479-87	MDM98479-19	MDM98479-79	MDM-97294-372	320-9505-014**	.935 (23.75)	.715 (18.16)	.308 (7.82)
21	MDM98479-88	MDM98479-20	MDM98479-80	MDM-97294-373	320-9505-014**	1.085 (27.56)	.865 (21.97)	.308 (7.82)
25	MDM98479-89	MDM98479-21	MDM98479-81	MDM-97294-374	320-9505-014**	1.185 (30.10)	.965 (24.51)	.308 (7.82)
31	MDM98479-90	MDM98479-14	MDM98479-82	MDM-97294-375	320-9505-014**	1.335 (33.91)	1.115 (28.32)	.308 (7.82)
37	MDM98479-91	MDM98479-15	MDM98479-83	MDM-97294-376	320-9505-014**	1.485 (37.72)	1.265 (32.13)	.308 (7.82)
51	MDM98479-92	MDM98479-16	MDM98479-84	MDM-97294-377	320-9505-014**	1.435 (36.45)	1.215 (30.86)	.351 (8.91)
100	MDM98479-93	MDM98479-17	MDM98479-85	MDM-97294-717	320-9508-014***	2.170 (55.12)	1.800 (45.72)	.394 (10.01)

* Kit contains 2 bushings-jackpost/jackscrew and 2 E rings.
 ** Size 9-51-#2-56 UNC2B Thread
 *** Size 100-#4-40 UNC2B Thread



How to Order - MIL-C-83513 Part Number Nomenclature

M83513/ - 01 - A ** C

SERIES

Connector, Electrical, Rectangular
Microminiature, Polarized Shell













MIL-C-83513 SLASH SHEET

- | | |
|--|---|
| 01 - Plug, Connector, Solderpot | } Metal Shell |
| 02 - Receptacle, Connector, Solderpot | |
| 03 - Plug, Connector, Crimp Type | |
| 04 - Receptacle, Connector, Crimp Type | |
| 05 - Hardware Only  | |
| 06 - Plug, Connector, Solderpot | } Plastic  |
| 07 - Receptacle, Connector, Solderpot | |
| 08 - Plug, Connector, Crimp Type | |
| 09 - Receptacle, Connector, Crimp Type | |

INSERT ARRANGEMENT





	<u>METAL SHELL</u>	<u>PLASTIC</u>
A -	9 Contact	9 Contact
B -	15 Contact	15 Contact
C -	21 Contact	21 Contact
D -	25 Contact	25 Contact
E -	31 Contact	31 Contact
F -	37 Contact	37 Contact
G -	51 Contact	51 Contact
H -	100 Contact	

WIRE TYPE

- No Number - For Solderpot
- | | | |
|------|--|---|
| 01 - | 18" long, #26 AWG per MIL-W-22759/11-26-9 | |
| 02 - | 36" long, #26 AWG per MIL-W-22759/11-26-9 | |
| 03 - | 18" long, #26 AWG per MIL-W-22759/11-26
Color Coded per MIL-STD-681, System 1 |  |
| 04 - | 36" long, #26 AWG per MIL-W-22759/11-26
Color Coded per MIL-STD-681, System 1 |  |
| 05 - | .5" long, #25 AWG, type S per QQ-W-343,
Gold Plated | |
| 06 - | 1.0" long, #25 AWG, type S per QQ-W-343,
Gold Plated | |
| 07 - | .5" long, #25 AWG, type S per QQ-W-W-343,
Tin Plated | |
| 08 - | 1.0" long, #25 AWG, type S per QQ-W-343,
Tin Plated | |
| 09 - | 18" long, #26 AWG per MIL-W-22759/33-26-9 |  |
| 10 - | 36" long, #26 AWG per MIL-W-22759/33-26-9 |  |
| 11 - | 18" long, #26 AWG per MIL-W-22759/33-26
Color Coded per MIL-STD-681, System 1 |   |
| 12 - | 36" long, #26 AWG per MIL-W-22759/33-26
Color Coded per MIL-STD-681, System 1 |   |
| 13 - | 72" long, #26 AWG per MIL-W-22759/11-26-9 | |
| 14 - | 72" long, #26 AWG per MIL-W-22759/11-26
Color Coded per MIL-STD-681, System 1 |  |
| 15 - | 72" long, #26 AWG per MIL-W-22759/33-26-9 |  |
| 16 - | 72" long, #26 AWG per MIL-W-22759/33-26
Color Coded per MIL-STD-681, System 1 |   |

NOTES:

(Specify when ordering, if necessary.)

-  - For every Mil-Spec P/N, ITT has one corresponding part numbers.
Example: ITT P/N's MDM01-A9
- 2 - Tolerance on wire lengths-18", 36" and 72" long,
+1.00"/-0.00"
.5" and 1.00" + .200"/-.000"
-  - For space application, connector shell finish must be "N" and wire must be per MIL-W-22759/33-26.
- 4 - Any deviations to these P/N's will result in assignment of a special P/N, consult factory.
-  - No size 100 in plastic type connector.
-  - Color coding in accordance with MIL-STD-681, System 1 except the appropriate color code is the individual contact cavity number minus 1 for contact positions.
-  - For mounting hardware to Military Specification (sizes 9 to 100) see page 238.

SHELL FINISH

- No letter - for plastic type connector
- C - Cadmium
- N - Electroless Nickel 

Qualification to slash sheets 10 thru 27 for the PCB connectors will be announced when completed.



MDM-PCB connectors are designed for use with flex circuitry, flat cable and printed circuit boards or multi-layer boards. They use the standard MDM metal shell and provide high density and high reliability in board-to-board, board-to-cable and cable-to-cable applications.

MDM-PCB connectors are available in 8 shell sizes with 9 to 100 contacts. Terminations may be straight (BS) or at 90° (BR, CBR) board thickness. Jackpost mounting for use with locking hardware is also available.

How to Order - MDM-PCB Series

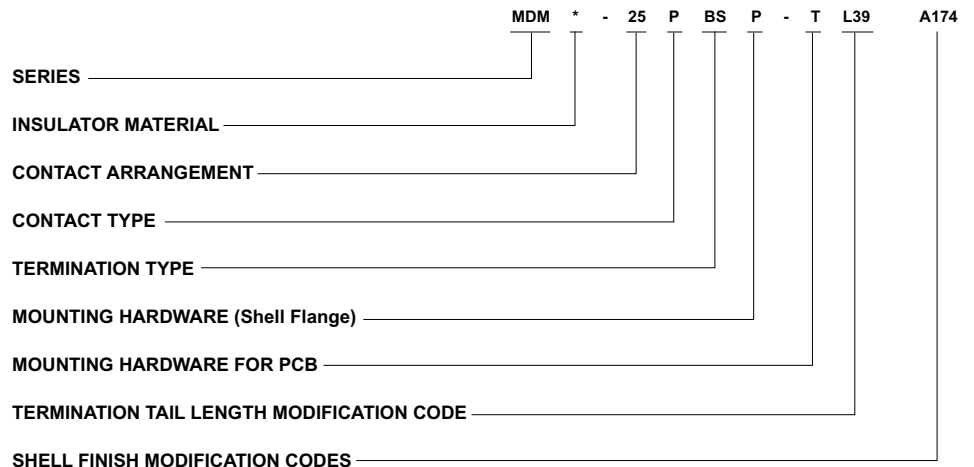

SERIES

MDM - Microm "D" Metal Shell

INSULATOR MATERIAL

Liquid Crystal Polymer (LCP)

CONTACT ARRANGEMENT

9, 15, 21, 25, 31, 37, 51, and 100
Size 100 not available in "BR"

CONTACT TYPE

P - Pin (Plug)
S - Socket (Receptacle)

TERMINATION TYPE

BS - Straight PCB Termination
BR - 90° PCB Termination
CBR - 90° Narrow Profile PCB Terminations

MOUNTING HARDWARE (Shell Flange)

P - Jackposts
M7 - Jackposts
M83513/5-07 (Sizes 9-51)
M17 - Jackposts
M83513/5-17 (Size 100)
No letter - none

MOUNTING HARDWARE FOR PCB

T - Threaded Insert
#2-56 Thd for Shell Sizes 9 thru 51
#4-40 Thd for Shell Size 100
No letter - none

TERMINATION TAIL LENGTH MODIFICATION CODE

None - .109 (2.77) ±.015 (0.38) Standard
L61 - .125 (3.18)
L56 - .150 (3.81)
L57 - .190 (4.83)
L39 - .250 (6.35)
L58 - .375 (9.52)

SHELL FINISH MODIFICATION CODES

None - Yellow Chromate/Cadmium over Nickel
A174 - Electroless Nickel
A172 - Gold over Nickel
A141 - Iridite/Alodine
A30 - Black Anodize
(For special modification codes, consult factory.)

NOTE: Back molding material - Epoxy Hysol #MG40FS

BS (Board Straight) Series



PCB Termination Arrangements* (Viewed from PCB solder side)

Identification number shown for plug connector, use reverse order for socket connector.

NOTE: Dimensions shown are for reference only-consult factory for final design dimensions.

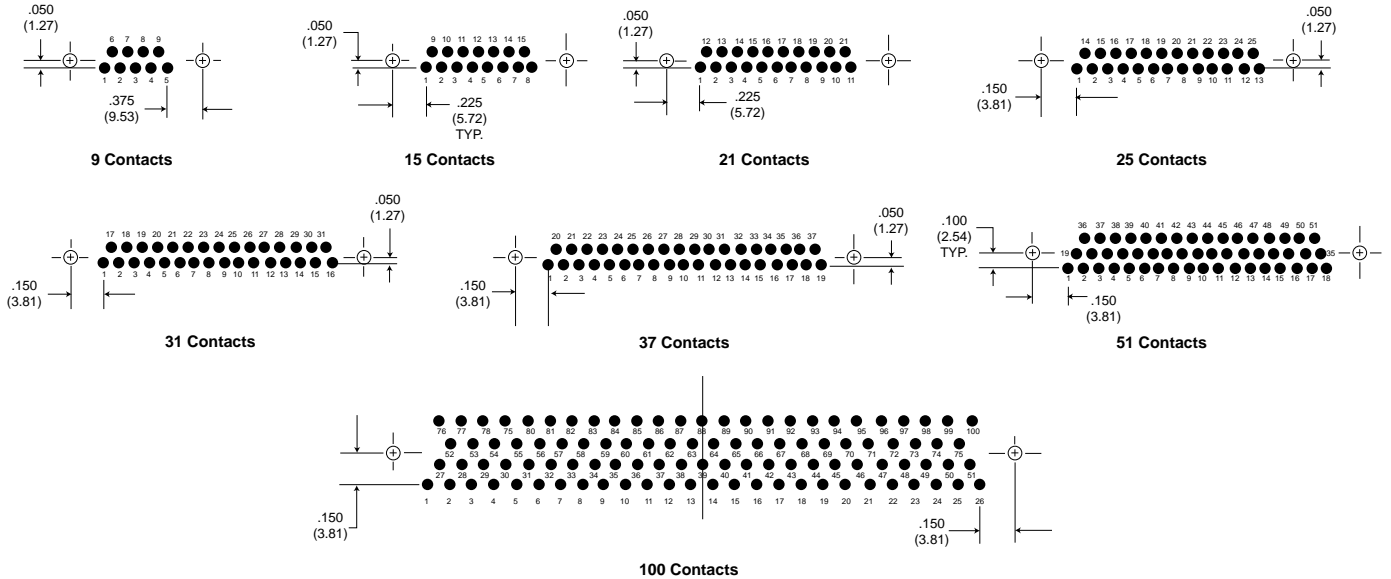

NOTE: Standard lead termination is #24 AWG, solid copper, solder or tin dipped

All Termination Configurations .100 (2.54) x .100 (2.54) Grid Pattern, Offset .050 (1.27)

Part Number By Shell Size	A	B	C	D	E	F	G	H	J	K
	Max.	±.007 (.018)	±.005 (.013)	Max.	Max.	Max.	Max.	Max.	Max.	Max.
MDM-9PBS*	1.390 (35.31)	1.150 (29.21)	.565 (14.35)	.785 (19.94)	.334 (8.48)	.185 (4.70)	.308 (7.82)	.165 (4.19)	.355 (9.02)	.555 (14.10)
MDM-9SBS*	1.390 (35.31)	1.150 (29.21)	.565 (14.35)	.785 (19.94)	.402 (10.21)	.253 (6.43)	.308 (7.82)	.165 (4.19)	.355 (9.02)	.555 (14.10)
MDM-15PBS*	1.390 (35.31)	1.150 (29.21)	.715 (18.16)	.935 (23.75)	.484 (12.29)	.185 (4.70)	.308 (7.82)	.165 (4.19)	.355 (9.02)	.555 (14.10)
MDM-15SBS*	1.390 (35.31)	1.150 (29.21)	.715 (18.16)	.935 (23.75)	.552 (13.97)	.253 (6.43)	.308 (7.82)	.165 (4.19)	.355 (9.02)	.555 (14.10)
MDM-21PBS*	1.690 (43.93)	1.450 (36.83)	.865 (21.97)	1.085 (27.56)	.634 (16.10)	.185 (4.70)	.308 (7.82)	.165 (4.19)	.355 (9.02)	.555 (14.10)
MDM-21SBS*	1.690 (43.93)	1.450 (36.83)	.865 (21.97)	1.085 (27.56)	.702 (17.83)	.253 (6.43)	.308 (7.82)	.165 (4.19)	.355 (9.02)	.555 (14.10)
MDM-25PBS	1.740 (44.20)	1.500 (38.10)	.965 (24.51)	1.185 (30.10)	.734 (18.64)	.185 (4.70)	.308 (7.82)	.165 (4.19)	.355 (9.02)	.555 (14.10)
MDM-25SBS*	1.740 (44.20)	1.500 (38.10)	.965 (24.51)	1.185 (30.10)	.802 (20.37)	.253 (6.43)	.308 (7.82)	.165 (4.19)	.355 (9.02)	.555 (14.10)
MDM-31PBS*	2.040 (51.82)	1.800 (45.72)	1.115 (28.32)	1.335 (33.91)	.884 (22.45)	.185 (4.70)	.308 (7.82)	.165 (4.19)	.355 (9.02)	.555 (14.10)
MDM-31SBS*	2.040 (51.82)	1.800 (45.72)	1.115 (28.32)	1.335 (33.91)	.952 (24.18)	.253 (6.43)	.308 (7.82)	.165 (4.19)	.355 (9.02)	.555 (14.10)
MDM-37PBS*	2.340 (59.44)	2.100 (53.34)	1.265 (32.13)	1.485 (37.72)	1.034 (26.26)	.185 (4.70)	.308 (7.82)	.165 (4.19)	.355 (9.02)	.555 (14.10)
MDM-37SBS*	2.340 (59.44)	2.100 (53.34)	1.265 (32.13)	1.485 (37.72)	1.102 (27.99)	.253 (6.43)	.308 (7.82)	.165 (4.19)	.355 (9.02)	.555 (14.10)
MDM-51PBS*	2.270 (67.66)	2.000 (50.80)	1.215 (30.86)	1.435 (36.45)	.984 (24.99)	.228 (5.79)	.351 (8.92)	.165 (4.19)	.355 (9.02)	.555 (14.10)
MDM-51SBS*	2.270 (67.66)	2.000 (50.80)	1.215 (30.86)	1.435 (36.45)	1.052 (26.72)	.296 (7.52)	.351 (8.92)	.165 (4.19)	.355 (9.02)	.555 (14.10)
MDM-100PBS*	3.070 (77.98)	2.800 (71.12)	1.800 (45.72)	2.175 (55.24)	1.384 (35.15)	.271 (6.88)	.460 (11.68)	.303 (7.70)	.550 (12.70)	.686 (17.42)
MDM-100SBS*	3.070 (77.98)	2.800 (71.12)	1.800 (45.72)	2.175 (55.24)	1.508 (38.30)	.394 (10.01)	.460 (11.68)	.303 (7.70)	.550 (12.70)	.686 (17.75)

*For jackpost, add letter "P" or "M7" for sizes 9-51, "M17" for size 100.

BR (Board Right Angle) Series

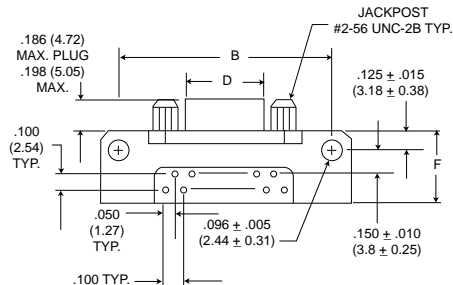
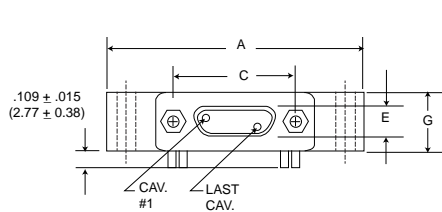

PCB Termination Arrangements (Viewed from bottom of connector, PCB solder side.)

Identification number shown for plug connector, use reverse order for socket connector.

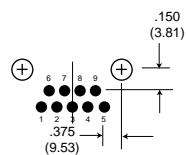

9 Contacts

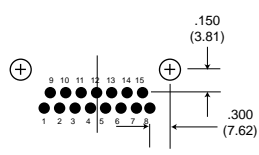

15 Contacts

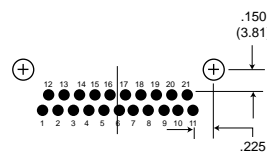

21 Contacts

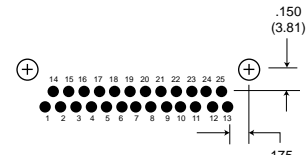

25 Contacts

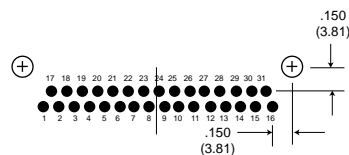

31 Contacts

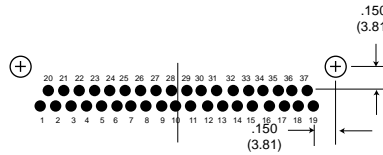

37 Contacts

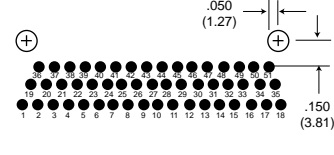

51 Contacts

NOTE: Standard lead termination is #24 AWG, gold plated, solid copper, solder or tin dripped.

All Termination Configurations .100 (2.54) x .100 (2.54) Grid Pattern, Offset .050 (1.27).

Part Number By Shell Size	A Max.	B ± .007 (.018)	C ± .005 (.013)	D Max.	E Max.	F Max.	G Max.
MDM-9PBR*	1.390 (35.31)	1.150 (29.21)	.565 (14.35)	.334 (8.48)	.185 (4.70)	.455 (11.56)	.308 (7.82)
MDM-9SBR*	1.390 (35.31)	1.150 (29.21)	.565 (14.35)	.402 (10.21)	.253 (6.43)	.455 (11.56)	.308 (7.82)
MDM-15PBR*	1.540 (39.12)	1.300 (33.02)	.715 (18.16)	.484 (12.29)	.185 (4.70)	.455 (11.56)	.308 (7.82)
MDM-15SBR*	1.540 (39.12)	1.300 (33.02)	.715 (18.16)	.552 (13.97)	.253 (6.43)	.455 (11.56)	.308 (7.82)
MDM-21PBR*	1.690 (42.93)	1.450 (36.83)	.865 (21.97)	.634 (16.10)	.185 (4.70)	.455 (11.56)	.308 (7.82)
MDM-21SBR*	1.690 (42.93)	1.450 (36.83)	.865 (21.97)	.702 (17.83)	.253 (6.43)	.455 (11.56)	.308 (7.82)
MDM-25PBR*	1.790 (45.47)	1.550 (39.37)	.965 (24.51)	.734 (18.64)	.185 (4.70)	.455 (11.56)	.308 (7.82)
MDM-25SBR*	1.790 (45.47)	1.550 (39.37)	.965 (24.51)	.802 (20.37)	.253 (6.43)	.455 (11.56)	.308 (7.82)
MDM-31PBR*	2.040 (51.82)	1.800 (45.72)	1.115 (28.32)	.884 (22.45)	.185 (4.70)	.455 (11.56)	.308 (7.82)
MDM-31SBR*	2.040 (51.82)	1.800 (45.72)	1.115 (28.32)	.952 (24.18)	.253 (6.43)	.455 (11.56)	.308 (7.82)
MDM-37PBR*	2.340 (59.44)	2.100 (53.34)	1.265 (32.13)	1.034 (26.26)	.185 (4.70)	.455 (11.56)	.308 (7.82)
MDM-37SBR*	2.340 (59.44)	2.100 (53.34)	1.265 (32.13)	1.102 (27.99)	.253 (6.43)	.455 (11.56)	.308 (7.82)
MDM-51PBR*	1.875 (47.63)	1.600 (40.64)	1.215 (30.86)	.984 (24.99)	.228 (5.79)	.565 (14.35)	.351 (8.92)
MDM-51SBR*	1.875 (47.63)	1.600 (40.64)	1.215 (30.86)	1.052 (26.72)	.296 (7.52)	.565 (14.35)	.351 (8.92)

*For jackpost, add letter "P" or "M" for sizes 9-51, "M17" for size 100.

CBR (Condensed Board Right Angle) Series

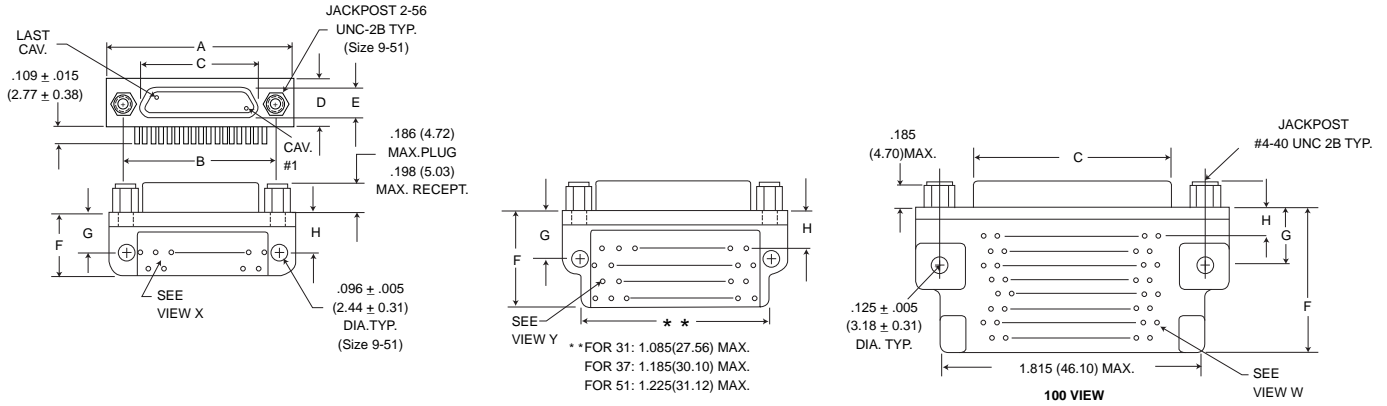

PCB Termination Arrangements (Viewed from bottom of connector, PCB solder side.)

Identification number shown for plug connector, use reverse order for socket connector.

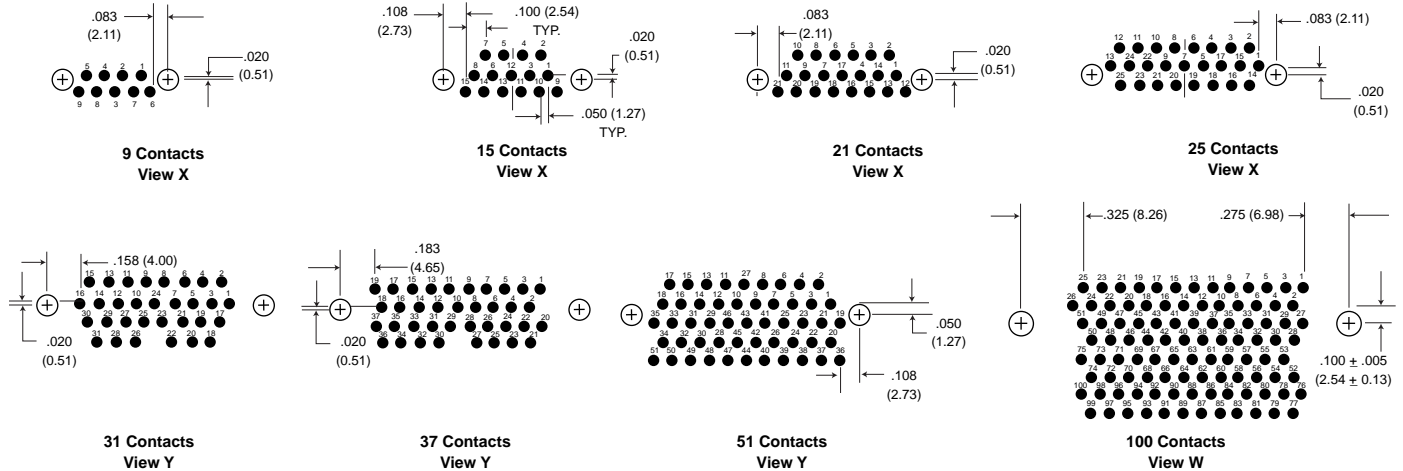

All Termination Configurations .100 (2.54) x .100 (2.54) Grid Pattern, Offset .050 (1.27).

NOTE: Standard lead termination is #24 AWG, solid copper, solder or tin dripped.

Part Number By Shell Size	A Max.	B ± .005 (.013)	C Max.	D Max.	E Max.	F Max.	G ± .010 (.025)	H ± .010 (.025)
MDM-9PCBR*	.785 (19.94)	.565 (14.35)	.334 (8.48)	.308 (7.82)	.185 (4.70)	.420 (10.67)	.250 (6.35)	.230 (5.81)
MDM-9SCBR*	.785 (19.94)	.565 (14.35)	.402 (10.21)	.308 (7.82)	.253 (6.43)	.420 (10.67)	.250 (6.35)	.230 (5.81)
MDM-15PCBR*	.935 (23.75)	.715 (18.16)	.484 (12.29)	.308 (7.82)	.185 (4.70)	.420 (10.67)	.250 (6.35)	.130 (3.30)
MDM-15SCBR*	.935 (23.75)	.715 (18.16)	.552 (13.97)	.308 (7.82)	.253 (6.43)	.420 (10.67)	.250 (6.35)	.130 (3.30)
MDM-21PCBR*	1.085 (27.56)	.865 (21.97)	.634 (16.10)	.308 (7.82)	.185 (4.70)	.420 (10.67)	.250 (6.35)	.130 (3.30)
MDM-21SCBR*	1.085 (27.56)	.865 (21.97)	.702 (17.83)	.308 (7.82)	.253 (6.43)	.420 (10.67)	.250 (6.35)	.130 (3.30)
MDM-25PCBR*	1.185 (30.10)	.965 (24.51)	.734 (18.64)	.308 (7.82)	.184 (4.70)	.420 (10.67)	.250 (6.35)	.130 (3.30)
MDM-25SCBR*	1.185 (30.10)	.965 (24.51)	.802 (20.37)	.308 (7.82)	.253 (6.43)	.420 (10.67)	.250 (6.35)	.130 (3.30)
MDM-31PCBR*	1.335 (33.91)	1.115 (28.32)	.884 (22.45)	.308 (7.82)	.185 (4.70)	.520 (13.21)	.250 (6.35)	.130 (3.30)
MDM-31SCBR*	1.335 (33.91)	1.115 (28.32)	.952 (24.18)	.308 (7.82)	.253 (6.43)	.520 (13.21)	.250 (6.35)	.130 (3.30)
MDM-37PCBR*	1.485 (37.72)	1.265 (32.13)	1.034 (26.26)	.308 (7.82)	.185 (4.70)	.520 (13.21)	.250 (6.35)	.130 (3.30)
MDM-37SCBR*	1.485 (37.72)	1.265 (32.13)	1.102 (27.99)	.308 (7.82)	.253 (6.43)	.520 (13.21)	.250 (6.35)	.130 (3.30)
MDM-51PCBR*	1.435 (36.45)	1.215 (30.86)	.984 (24.99)	.351 (8.92)	.228 (5.79)	.650 (16.15)	.300 (7.62)	.150 (3.81)
MDM-51SCBR*	1.435 (36.45)	1.215 (30.86)	1.052 (26.72)	.351 (8.92)	.296 (7.52)	.650 (16.15)	.300 (7.62)	.150 (3.81)
MDM-100PCBR*	2.170 (55.12)	1.800 (45.72)	1.384 (35.15)	.394 (10.01)	.271 (6.88)	1.000 (25.40)	.400 (10.16)	.200 (5.08)
MDM-100SCBR*	2.170 (55.12)	1.800 (45.72)	1.508 (38.10)	.394 (10.01)	.394 (10.01)	1.000 (25.40)	.400 (10.16)	.200 (5.08)

*For jackpost, add letter "P" or "M7" for sizes 9-51, "M17" for size 100.

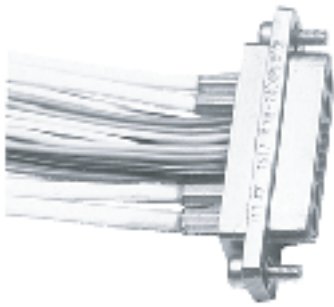

MDM Coaxial

The MDM Metal Shell Connectors have been tooled in several coaxial layouts and offer the versatility of combining coaxial and signal lines in the same connector. Any modifications to these layouts or new requirements, please consult the factory. For ordering information see page 232. For contact layouts see page 233. Standard coax is RG178 white.

MDM Power

The same insulator that is used with coaxial contacts is available with power contacts. This offers the versatility of combining power and signal lines in the same connector.

MDM Coaxial/Power

Power and coaxial contacts can be interchanged as desired. Power contacts are rated at 13 amps, 24V rms, AWG #16 stranded.

7C2/7P2

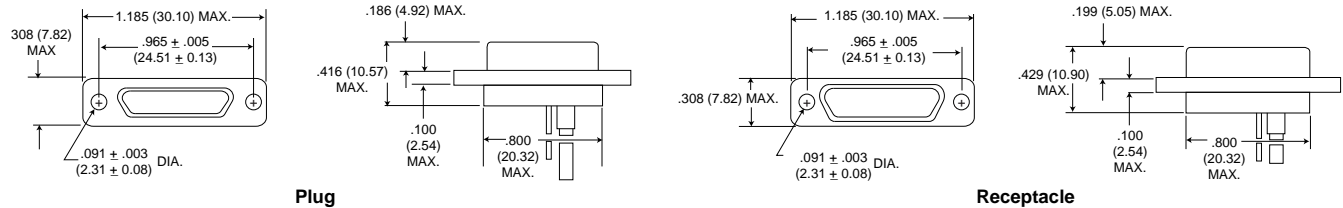

24C4/24P4

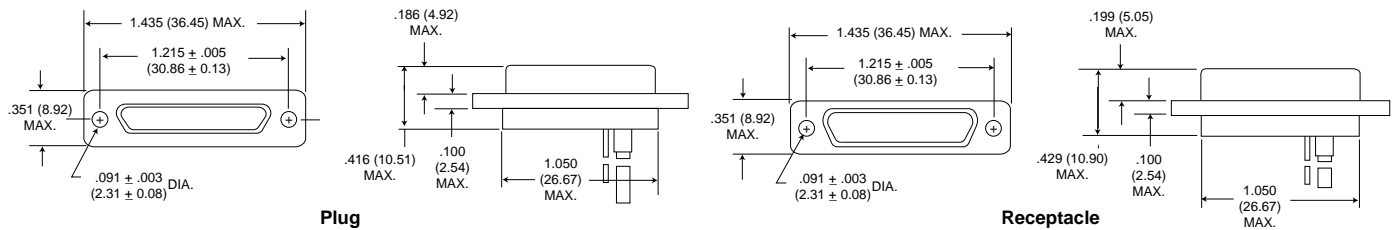

Coaxial Contacts

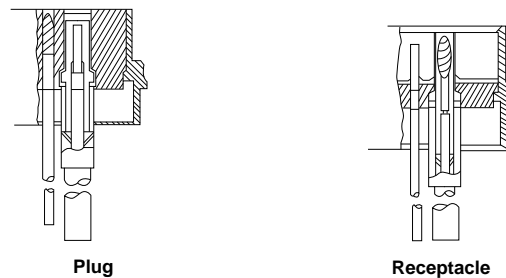

Power Contacts

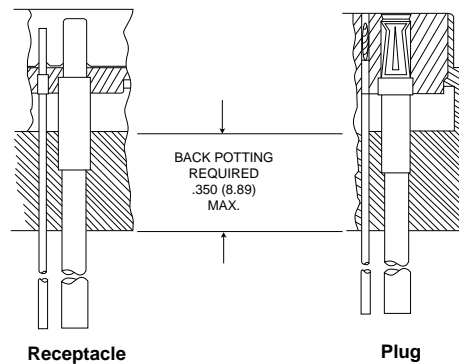

Microminiature Rectangular Connectors with MICRO-Pin Contacts on .050 (1.27) centers.

MICRO-D microminiature rack/panel connectors are used in applications requiring highly reliable, extremely small, lightweight connectors.

These connectors are available in 2 insulator materials, 2 mounting variations, 7 shell sizes accommodating from 9 to 51 contacts and a special arrangement of 5 micro contacts and 2 coaxials. The insulator materials listed give the MICRO-D connector wide versatility in most applications required by industry.

ITT Cannon can also terminate a wide variety of stranded or solid wire directly to MICRO-D contacts, which is often desirable in high density arrangements.

MICRO-D connectors can also be custom harnessed to meet any customer requirement of single or multiple connectors. Pigtail lead and harness description must be given by the customer. A typical description would be: .5" #25 AWG, gold plated copper leads or 18" of #26 yellow, Teflon-insulated, Type E wire. Shown below are various methods of termination. Consult the factory for any routine or complex harnessing of MICRO-D connectors.

- Glass-filled diallyl phthalate-a thermoset material used in high temperature applications that is immune to cleaning solvents. It also has excellent dielectric properties. Temperature range: -65°F to +300°F (-55°C to +149°C).

- Glass-filled polyester-a thermoplastic that is not affected by cleaning solvents and exhibits excellent dielectric properties. Temperature range: -55°F to +257°F (-65°C to +125°C).

How to Order

PCB ordering information - page 242

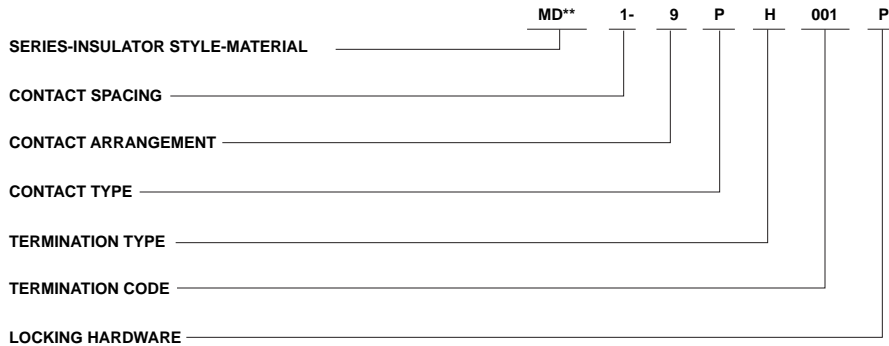

SERIES-INSULATOR STYLE-MATERIAL

- MD - Clip mounting -Diallyl phthalate
- MDB - Screw mounting-Diallyl phthalate
- MDV - Clip mounting-Polyester
- MDVB - Screw mounting-Polyester

CONTACT SPACING

- 1 - .050 (1.27) centers

CONTACT ARRANGEMENT

- 9-15-21-25-31*-37-51. See page 233.

CONTACT TYPE

- P - Pin
- S - Socket

TERMINATION TYPE

- H - Insulated solid or stranded wire
- L - Uninsulated solid wire
- S - Solder pot to accept #26 AWG max. harness wire.

TERMINATION CODE**

- (H) 001 - 18", 7/34 strand, #26 AWG, MIL-W-16878/4, Type E Teflon, Yellow.
- (H) 003 - 18", 7/34 strand, #26 AWG, MIL-W-16878/4, Type E Teflon, color coded to MIL-STD-681 System I.
- (L) 1 - 1/2" uninsulated solid #25 AWG gold plated copper.
- (L) 2 - 1" uninsulated solid #25 AWG gold plated copper.

LOCKING HARDWARE (SCREW MOUNTING ONLY)

- P - Jackpost
- K - Jackscrew-standard
- L - Jackscrew-low profile
- F - Float mount
- M - Military specification hardware, see page 237.
- No designator - No hardware - standard mounting .091 (2.31) hole diameter

* Not available in clip mounting.

** See table below for additional codes.

Standard Wire Termination Codes

For lengths not shown, consult factory for proper modification code. All wire lengths are minimum.

Harness Type (H)

#26 AWG per MIL-W-16878 Type E Teflon, stranded.

Length	All Yellow	Color Coded*
3 (76.2)	H020	H027
6 (152.4)	H019	H016
8 (203.2)	H026	H034
10 (254.0)	H029	H025
12 (304.8)	H028	H002
18 (457.2)	H001	H003
20 (508.0)	H038	H023
24 (609.6)	H009	H004
30 (762.0)	H010	H005
36 (914.4)	H011	H006
48 (1219.2)	H013	H048
72 (1828.8)	H017	H046
120 (3048.0)	H042	H041

* Cavity #1 black

Solid Uninsulated Type (L)

#25 AWG Gold Plated Copper

Termination Code	Length
L61	.125 (3.18)
L56	.150 (3.81)
L57	.190 (4.83)
L39	.250 (6.35)
L58	.375 (9.52)
L1	.500 (12.70)
L14	.750 (19.05)
L2	1.000 (25.40)
L7	1.500 (38.10)
L6	2.000 (50.80)
L16	2.500 (63.50)
L10	3.000 (76.20)