



# Micro-D Metal Shell Printed Circuit Board Connectors CBR Style Right Angle Thru-Hole



**High Performance** – These connectors feature gold-plated TwistPin contacts for best performance. PC tails are .020 inch diameter. Specify nickel-plated shells or cadmium plated shells for best availability.

**Solder-Dipped** – Terminals are coated with SN63/Pb37 tin-lead solder for best solderability. Optional gold-plated terminals are available for RoHS compliance.

**Front Panel or Rear Mountable** – Can be installed through panels up to .125 inch thick. Specify rear panel mount jackposts.

## HOW TO ORDER CBR STYLE PCB MICRO-D CONNECTORS

Series	Shell Material and Finish	Insulator Material	Contact Layout	Contact Type	Termination Type	Jackpost Option	Threaded Insert Option	Terminal Length In Inches	Gold-Plated Terminal Mod Code			
MWDM	Aluminum Shell	L – LCP 30% Glass-Filled Liquid Crystal Polymer	9	P Pin	CBR Condensed Board Right Angle	(Omit for None) P – Jackpost	T	.080	These connectors are solder-dipped in 63/37 tin-lead solder.  To delete the solder dip and change to gold-plated terminals, add code 513			
	1 – Cadmium		15					S Socket		Jackposts for Rear Panel Mounting	Threaded Insert In Board Mount Hole	.110
	2 – Nickel		21									.125
	4 – Black Anodize		25	R1 – .032" Panel R2 – .047" Panel R3 – .062" Panel R4 – .093" Panel R5 – .125" Panel		(Omit for Thru-Hole)	.140					
	5 – Gold		31				.150					
	6 – Chem Film		37				.172					
	Stainless Steel Shell	51	.190									
	3 – Passivated	69	.250	Length in Inches ± .015 (0.38)								
	100											
	<b>Sample Part Number</b>											
MWDM	1	L	- 15	P	CBR	R3		- .110				

## MICRO-D JACKPOST OPTIONS

<p><b>No Designator</b></p> <p>HEX NUT EPOXY FILL</p>	<p><b>P</b></p>	<p><b>R1 Thru R5</b></p> <p>Panel</p>
<p><b>Thru-Hole</b></p> <p>For use with Glenair jackposts only. Order hardware separately. Install with threadlocking compound.</p>	<p><b>Standard Jackpost</b></p> <p>Factory installed, not intended for removal.</p>	<p><b>Jackpost for Rear Panel Mounting</b></p> <p>Shipped loosely installed. Install with permanent threadlocking compound.</p>

# Micro-D Metal Shell Printed Circuit Board Connectors CBR Style Right Angle Thru-Hole



Micro-D  
PCB

## PERFORMANCE SPECIFICATIONS

Current Rating	3 AMP
DWV	600 VAC Sea level
Insulation Resistance	5000 Megohms Minimum
Contact Resistance	8 Milliohms Maximum
Low Level Contact Resist.	32 Milliohms Maximum
Magnetic Permeability	2 $\mu$ Maximum
Operating Temperature	-55° C. to +150° C.
Shock, Vibration	50 g., 20g.
Mating Force	(10 Ounces) X (# of Contacts)

## MATERIALS AND FINISHES

Connector Shell	Aluminum Alloy 6061 or Stainless Steel, 300 Series, passivated. See Ordering Info for Plating Options
Insulator, Tray	Liquid Crystal Polymer (LCP)
Interfacial Seal	Flourosilicone Rubber, Blue
Pin Contact	Beryllium Copper Gold over Nickel Plating
Socket Contact	Copper Alloy Gold Over Nickel Plating
PCB Terminals	Gold Plated Copper Alloy, Solder Dipped
Hardware	300 Series Stainless Steel
Encapsulant	Epoxy Resin Hysol EE4215

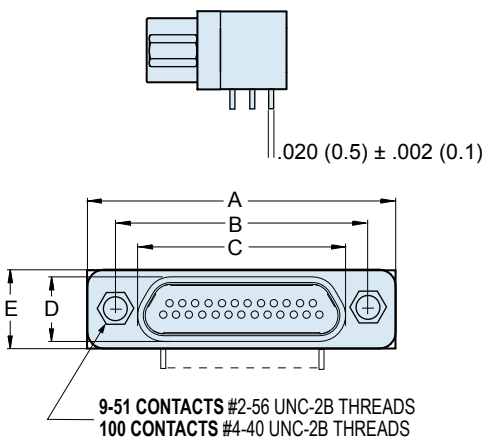

CONFIGURATION FOR 9-25 CONTACTS

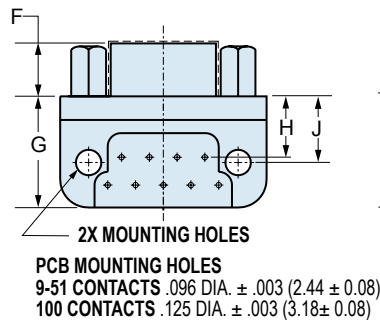

CONFIGURATION FOR 31-100 CONTACTS

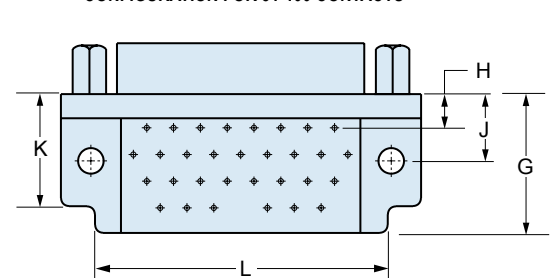

## DIMENSIONS

Layout	A Max.		B		C Max.		D Max.		E Max.		F		G Max.		H		J		K Max.		L Max.	
	In.	mm.	In. $\pm .003$	mm. $\pm 0.08$	In.	mm.	In.	mm.	In.	mm.	In. $\pm .003$	mm. $\pm 0.08$	In.	mm.	In. $\pm .010$	mm. $\pm 0.25$	In. $\pm .010$	mm. $\pm 0.25$	In.	mm.	In.	mm.
9P	.787	19.94	.565	14.35	.333	8.46	.184	4.67	.310	7.87	.183	4.65	.425	10.80	.230	5.84	.250	6.35				
9S	.787	19.94	.565	14.35	.400	10.16	.250	6.35	.310	7.87	.195	4.95	.425	10.80	.230	5.84	.250	6.35				
15P	.937	23.75	.715	18.16	.483	12.27	.184	4.67	.310	7.87	.183	4.65	.425	10.80	.130	3.30	.250	6.35				
15S	.937	23.75	.715	18.16	.551	14.00	.250	6.35	.310	7.87	.195	4.95	.425	10.80	.130	3.30	.250	6.35				
21P	1.087	27.56	.865	21.97	.633	16.08	.184	4.67	.310	7.87	.183	4.65	.425	10.80	.130	3.30	.250	6.35				
21S	1.087	27.56	.865	21.97	.701	17.81	.250	6.35	.310	7.87	.195	4.95	.425	10.80	.130	3.30	.250	6.35				
25P	1.187	30.01	.965	24.51	.733	18.62	.184	4.67	.310	7.87	.183	4.65	.425	10.80	.130	3.30	.250	6.35				
25S	1.187	30.01	.965	24.51	.801	20.35	.250	6.35	.310	7.87	.195	4.95	.425	10.80	.130	3.30	.250	6.35				
31P	1.337	33.91	1.115	28.32	.883	22.43	.184	4.67	.310	7.87	.183	4.65	.525	13.34	.130	3.30	.250	6.35	.450	11.43	1.085	27.56
31S	1.337	33.91	1.115	28.32	.951	24.16	.250	6.35	.310	7.87	.195	4.95	.525	13.34	.130	3.30	.250	6.35	.450	11.43	1.085	27.56
37P	1.487	37.72	1.265	32.13	1.033	26.24	.184	4.67	.310	7.87	.183	4.65	.525	13.34	.130	3.30	.250	6.35	.450	11.43	1.185	30.10
37S	1.487	37.72	1.265	32.13	1.101	27.96	.250	6.35	.310	7.87	.195	4.95	.525	13.34	.130	3.30	.250	6.35	.450	11.43	1.185	30.10
51P	1.435	36.45	1.215	30.86	.983	24.97	.224	5.69	.351	8.92	.183	4.65	.660	16.76	.150	3.81	.300	7.62	.450	11.43	1.225	31.12
51S	1.435	36.45	1.215	30.86	1.051	26.70	.293	7.44	.351	8.92	.195	4.95	.660	16.76	.150	3.81	.300	7.62	.450	11.43	1.225	31.12
69P	1.735	44.06	1.515	38.48	1.284	32.61	.224	5.69	.351	8.92	.183	4.65	.660	16.76	.150	3.81	.300	7.62	.450	11.43	1.225	31.12
69S	1.735	44.06	1.515	38.48	1.350	33.75	.293	7.44	.351	8.92	.195	4.95	.660	16.76	.150	3.81	.300	7.62	.450	11.43	1.225	31.12
100P	2.175	55.12	1.800	45.72	1.383	35.13	.270	6.86	.394	10.01	.183	4.65	1.010	25.65	.200	5.08	.400	10.16	.590	14.99	1.820	46.23
100S	2.175	55.12	1.800	45.72	1.451	36.86	.333	8.46	.394	10.01	.195	4.95	1.010	25.65	.200	5.08	.400	10.16	.590	14.99	1.820	46.23

## MICRO-D CBR BOARD MOUNT CONNECTOR PCB LAYOUTS – PIN CONNECTORS

Patterns shown are for connector mounting side of PC board. 9 Thru 51 Contacts .096 (2.44) Diameter Mounting Holes, 100 Pin .125 (3.18) Diameter

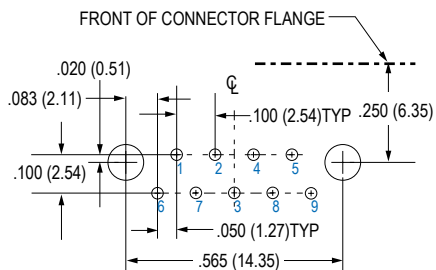

**9 PIN MWDM-9PCBR**

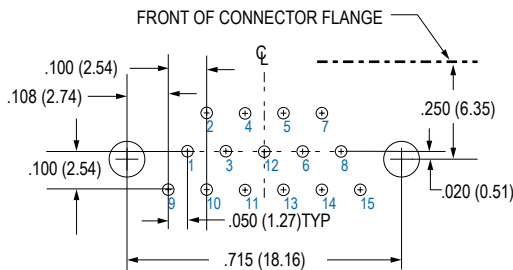

**15 PIN MWDM-15PCBR**

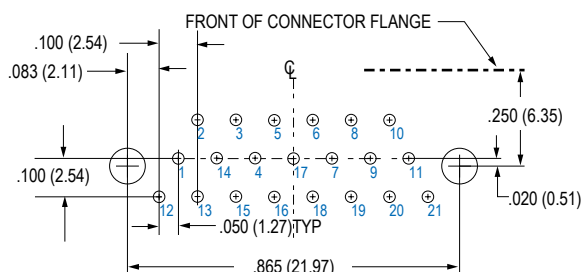

**21 PIN MWDM-21PCBR**

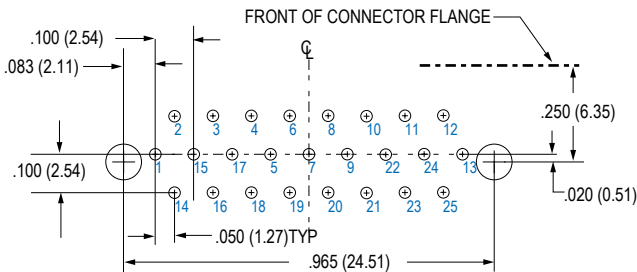

**25 PIN MWDM-25PCBR**

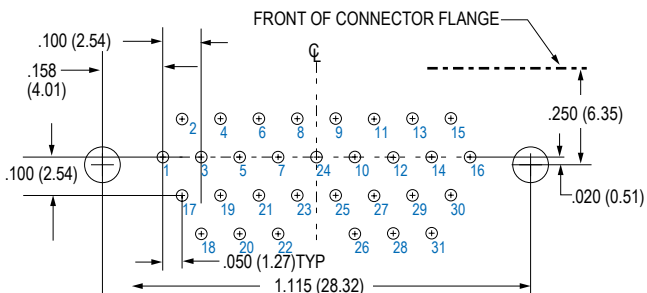

**31 PIN MWDM-31PCBR**

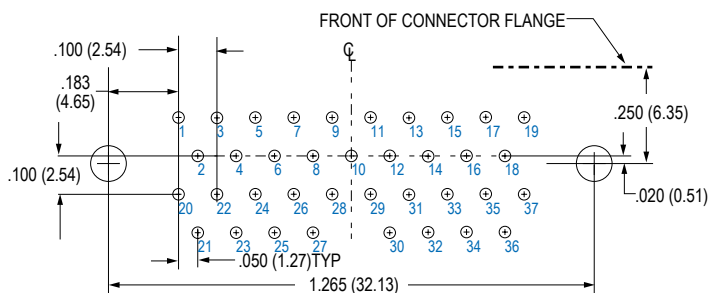

**37 PIN MWDM-37PCBR**

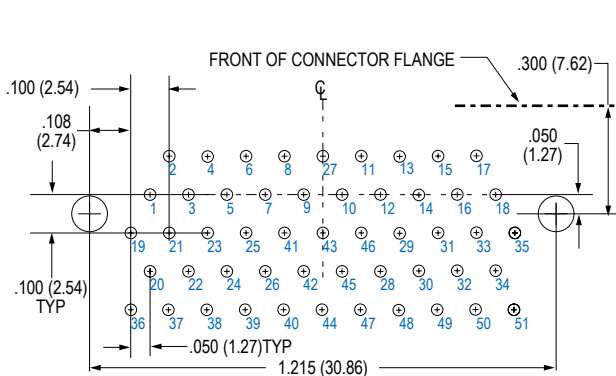

**51 PIN MWDM-51PCBR**

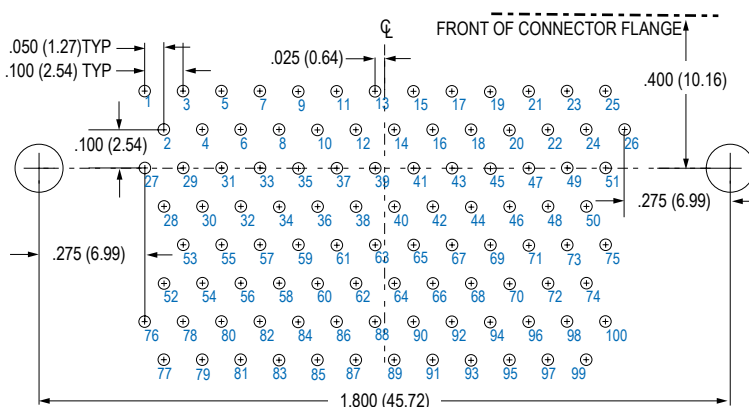

**100 PIN MWDM-100PCBR**

# Micro-D Metal Shell Printed Circuit Board Connectors CBR Style Right Angle Thru-Hole



## MICRO-D CBR BOARD MOUNT CONNECTOR PCB LAYOUTS – SOCKET CONNECTORS

Patterns shown are for connector mounting side of PC board. 9 Thru 51 Contacts .096 (2.44) Diameter Mounting Holes, 100 Pin .125 (3.18) Diameter

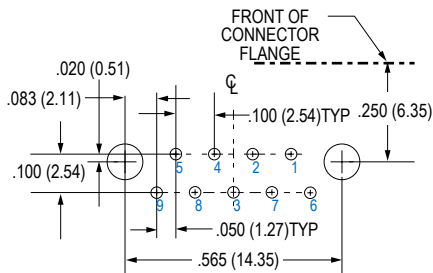

**9 SOCKET MWDM-9SCBR**

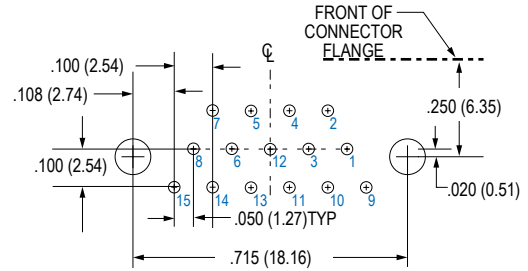

**15 SOCKET MWDM-15SCBR**

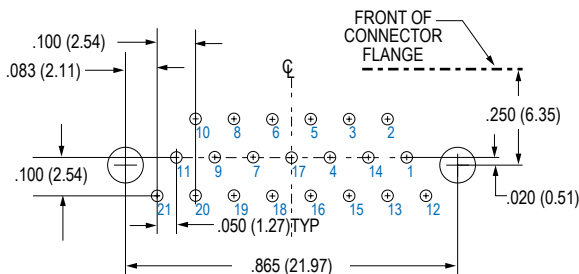

**21 SOCKET MWDM-21SCBR**

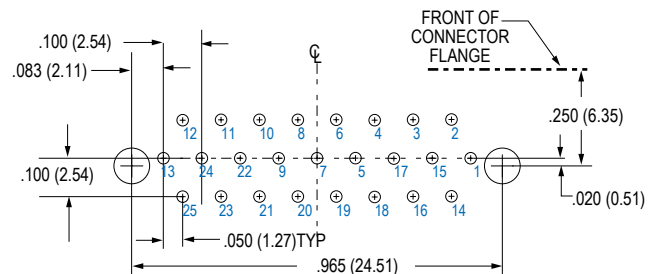

**25 SOCKET MWDM-25SCBR**

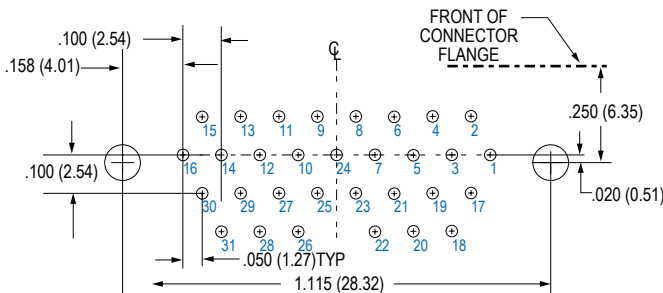

**31 SOCKET MWDM-31SCBR**

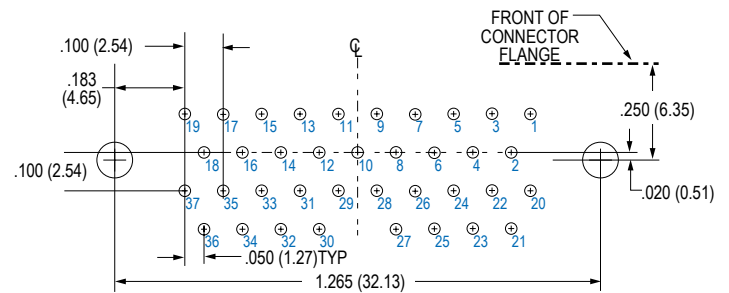

**37 SOCKET MWDM-37SCBR**

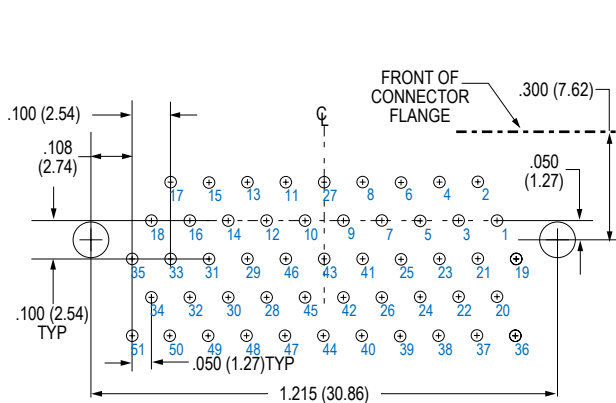

**51 SOCKET MWDM-51SCBR**

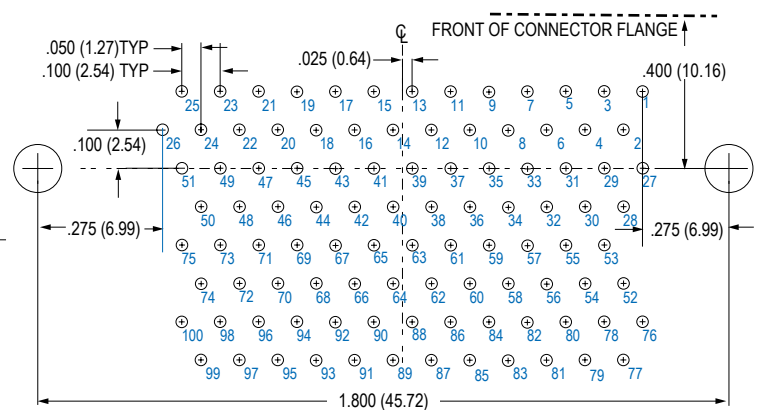

**100 SOCKET MWDM-100SCBR**

