

"ZNR" Transient/Surge Absorbers

Type: **D**

Series: **V**

"ZNR" Transient/Surge Absorber, Series V, Type D features large surge current and energy handling capability for absorbing transient overvoltage in a compact size.



■ Features

- Large withstanding surge current capability in compact sizes
- Large "Energy Handling Capability" absorbing transient overvoltages in compact sizes
- Wide range of varistor voltages
- The standard products shown below have received UL, CSA and VDE standards
 Varistor voltage 82-150V : UL, VDE
 Varistor voltage 200V over : UL, CSA, VDE
 (cf. Application Notes for UL/CSA, VDE recognized parts on page 322 to 323)

■ Recommended Applications

- Transistor, diode, IC, thyristor or triac semiconductor protection
- Surge protection in consumer electronic equipment
- Surge protection in communication, measuring or controller electronics
- Surge protection in electronic home appliances, gas or petroleum appliances
- Relay or electromagnetic valve surge absorption

■ Related Standards

- UL1414, UL1449
- CSA C22.2 No.1 Class 2221 01
 VDE CECC42000, CECC42200, CECC42201, IEC61051
- "Type Designation(UL)", "Part Number(CSA)", "Style Ref. (VDE)"
 Are not registered by product Part No..
 (Refer to page 322, for the details)

■ Handling Precautions

Please see Pages 335 to 337

■ Minimum Quantity / Packing Unit

Please see Page 360

■ Explanation of Part Numbers (Bulk)



■ Explanation of Part Numbers (Taping)



Design and specifications are each subject to change without notice. Ask factory for the current technical specifications before purchase and/or use. Should a safety concern arise regarding this product, please be sure to contact us immediately.

Reference Guide to Standard Products

Part No.	Varistor Voltage*	Maximum Allowable Voltage		Clamping Voltage @8/20μs		Maximum Energy (J)		Maximum Peak Current @8/20μs(A)		Recommended Applications
	(V)	ACrms (V)	DC (V)	max.(V)	I _p (A)	10/1000 μs	2 ms	1 time	2 times	
ERZV05D180	18 (16-20)	11	14	40	1	0.6	0.4	250	125	For the low voltage circuit
ERZV07D180				36	2.5	1.1	0.9	500	250	
ERZV09D180				36	5	2.6	2.2	1000	500	
ERZV10D180				36	5	2.6	2.2	1000	500	
ERZV14D180				36	10	5.2	4.3	2000	1000	
ERZV20D180				36	20	13	12	3000	2000	
ERZV05D220	22 (20-24)	14	18	48	1	0.7	0.5	250	125	
ERZV07D220				43	2.5	1.3	1.1	500	250	
ERZV09D220				43	5	3.2	2.6	1000	500	
ERZV10D220				43	5	3.2	2.6	1000	500	
ERZV14D220				43	10	6.3	5.3	2000	1000	
ERZV20D220				43	20	16	14	3000	2000	
ERZV05D270	27 (24-30)	17	22	60	1	0.9	0.7	250	125	
ERZV07D270				53	2.5	1.6	1.3	500	250	
ERZV09D270				53	5	3.9	3.2	1000	500	
ERZV10D270				53	5	3.9	3.2	1000	500	
ERZV14D270				53	10	7.8	6.5	2000	1000	
ERZV20D270				53	20	19	17	3000	2000	
ERZV05D330	33 (30-36)	20	26	73	1	1.1	0.8	250	125	
ERZV07D330				65	2.5	2.0	1.6	500	250	
ERZV09D330				65	5	4.8	4.0	1000	500	
ERZV10D330				65	5	4.8	4.0	1000	500	
ERZV14D330				65	10	9.5	7.9	2000	1000	
ERZV20D330				65	20	24	21	3000	2000	
ERZV05D390	39 (35-43)	25	31	86	1	1.2	0.9	250	125	
ERZV07D390				77	2.5	2.4	1.9	500	250	
ERZV09D390				77	5	5.6	4.7	1000	500	
ERZV10D390				77	5	5.6	4.7	1000	500	
ERZV14D390				77	10	11	9.4	2000	1000	
ERZV20D390				77	20	28	25	3000	2000	
ERZV05D470	47 (42-52)	30	38	104	1	1.5	1.1	250	125	
ERZV07D470				93	2.5	2.8	2.3	500	250	
ERZV09D470				93	5	6.8	5.6	1000	500	
ERZV10D470				93	5	6.8	5.6	1000	500	
ERZV14D470				93	10	14	11	2000	1000	
ERZV20D470				93	20	34	30	3000	2000	
ERZV05D560	56 (50-62)	35	45	123	1	1.8	1.3	250	125	
ERZV07D560				110	2.5	3.4	2.7	500	250	
ERZV09D560				110	5	8.1	6.7	1000	500	
ERZV10D560				110	5	8.1	6.7	1000	500	
ERZV14D560				110	10	16	13	2000	1000	
ERZV20D560				110	20	41	36	3000	2000	
ERZV05D680	68 (61-75)	40	56	150	1	2.2	1.6	250	125	
ERZV07D680				135	2.5	4.1	3.3	500	250	
ERZV09D680				135	5	9.8	8.2	1000	500	
ERZV10D680				135	5	9.8	8.2	1000	500	
ERZV14D680				135	10	20	16	2000	1000	
ERZV20D680				135	20	49	44	3000	2000	
ERZV05D820	82 (74-90)	50	65	145	5	3.5	2.5	800	600	Telephone, Communication Line (DC 48 V)
ERZV07D820				135	10	7	5	1750	1250	
ERZV09D820				135	25	14	10	3500	2500	
ERZV10D820				135	25	14	10	3500	2500	
ERZV14D820				135	50	28	20	6000	5000	
ERZV20D820				135	100	56	40	10000	7000	

* Measuring Current of Varistor Voltage - 5 Series : 0.1 mA, Others: 1 mA

Design and specifications are each subject to change without notice. Ask factory for the current technical specifications before purchase and/or use. Should a safety concern arise regarding this product, please be sure to contact us immediately.

Reference Guide to Standard Products

Part No.	Varistor Voltage*	Maximum Allowable Voltage		Clamping Voltage @8/20 μ s		Maximum Energy (J)		Maximum Peak Current @8/20 μ s(A)		Recommended Applications	
	(V)	ACrms (V)	DC (V)	max.(V)	I _p (A)	10/1000 μ s	2 ms	1 time	2 times		
ERZV05D101	100 (90-110)	60	85	175	5	4	3	800	600	Telephone, Communication Line (DC 48 V)	
ERZV07D101				165	10	8.5	6	1750	1250		
ERZV09D101				165	25	17	12	3500	2500		
ERZV10D101				165	25	17	12	3500	2500		
ERZV14D101				165	50	35	25	6000	5000		
ERZV20D101				165	100	70	50	10000	7000		
ERZV05D121	120 (108-132)	75	100	210	5	5	3.5	800	600		
ERZV07D121				200	10	10	7	1750	1250		
ERZV09D121				200	25	20	14.5	3500	2500		
ERZV10D121				200	25	20	14.5	3500	2500		
ERZV14D121				200	50	42	30	6000	5000		
ERZV20D121				200	100	85	60	10000	7000		
ERZV05D151	150 (135-165)	95	125	260	5	6.5	4.5	800	600		
ERZV07D151				250	10	13	9	1750	1250		
ERZV09D151				250	25	25	18	3500	2500		
ERZV10D151				250	25	25	18	3500	2500		
ERZV14D151				250	50	53	37.5	6000	5000		
ERZV20D151				250	100	106	75	10000	7000		
ERZV05D201	200 (185-225)	130	170	355	5	8.5	6	800	600	AC 100 V Line-Line Applications	
ERZV07D201				340	10	17.5	12.5	1750	1250		
ERZV09D201				340	25	35	25	3500	2500		
ERZV10D201				340	25	35	25	3500	2500		
ERZV14D201				340	50	70	50	6000	5000		
ERZV20D201				340	100	140	100	10000	7000		
ERZV05D221	220 (198-242)	140	180	380	5	9	6.5	800	600		
ERZV07D221				360	10	19	13.5	1750	1250		
ERZV09D221				360	25	39	27.5	3500	2500		
ERZV10D221				360	25	39	27.5	3500	2500		
ERZV14D221				360	50	78	55	6000	5000		
ERZV20D221				360	100	155	110	10000	7000		
ERZV05D241	240 (216-264)	150	200	415	5	10.5	7.5	800	600		AC 100 V to 120 V, Line-Line Applications
ERZV07D241				395	10	21	15	1750	1250		
ERZV09D241				395	25	42	30	3500	2500		
ERZV10D241				395	25	42	30	3500	2500		
ERZV14D241				395	50	84	60	6000	5000		
ERZV20D241				395	100	168	120	10000	7000		
ERZV05D271	270 (247-303)	175	225	475	5	11	8	800	600		
ERZV07D271				455	10	24	17	1750	1250		
ERZV09D271				455	25	49	35	3500	2500		
ERZV10D271				455	25	49	35	3500	2500		
ERZV14D271				455	50	99	70	6000	5000		
ERZV20D271				455	100	190	135	10000	7000		
ERZV05D331	330 (297-363)	210	270	570	5	13	9.5	800	600	AC 100 V to 120 V, Line-Line Applications	
ERZV07D331				545	10	28	20	1750	1250		
ERZV09D331				545	25	58	42	3500	2500		
ERZV10D331				545	25	58	42	3500	2500		
ERZV14D331				545	50	115	80	6000	4500		
ERZV20D331				545	100	228	160	10000	6500		
ERZV05D361	360 (324-396)	230	300	620	5	16	11	800	600		Telephone Line Applications, (250 V Insulation Resistance Test Applicable)
ERZV07D361				595	10	32	23	1750	1250		
ERZV09D361				595	25	65	45	3500	2500		
ERZV10D361				595	25	65	45	3500	2500		
ERZV14D361				595	50	130	90	6000	4500		
ERZV20D361				595	100	255	180	10000	6500		

* Measuring Current of Varistor Voltage - 5 Series : 0.1 mA, Others: 1 mA

Design and specifications are each subject to change without notice. Ask factory for the current technical specifications before purchase and/or use.
Should a safety concern arise regarding this product, please be sure to contact us immediately.

00 Sep. 2010

Reference Guide to Standard Products

Part No.	Varistor Voltage*	Maximum Allowable Voltage		Clamping Voltage @8/20μs		Maximum Energy (J)		Maximum Peak Current @8/20μs(A)		Recommended Applications
	(V)	ACrms (V)	DC (V)	max.(V)	I _p (A)	10/1000 μs	2 ms	1 time	2 times	
ERZV05D391	390 (351-429)	250	320	675	5	17	12	800	600	AC 100 V to 120 V, Line-Line Applications Telephone Line Applications, (250 V Insulation Resistance Test Applicable)
ERZV07D391				650	10	35	25	1750	1250	
ERZV09D391				650	25	70	50	3500	2500	
ERZV10D391				650	25	70	50	3500	2500	
ERZV14D391				650	50	140	100	6000	4500	
ERZV20D391				650	100	275	195	10000	6500	
ERZV05D431	430 (387-473)	275	350	745	5	20	13.5	800	600	AC 100 V to 220 V, Line-Line and AC 100 V to 220 V, Line-Ground Applications
ERZV07D431				710	10	40	27.5	1750	1250	
ERZV09D431				710	25	80	55	3500	2500	
ERZV10D431				710	25	80	55	3500	2500	
ERZV14D431				710	50	155	110	6000	4500	
ERZV20D431				710	100	303	215	10000	6500	
ERZV05D471	470 (423-517)	300	385	810	5	21	15	800	600	AC 100 V to 220 V, Line-Line and AC 100 V to 220 V, Line-Ground Applications
ERZV07D471				775	10	42	30	1750	1250	
ERZV09D471				775	25	85	60	3500	2500	
ERZV10D471				775	25	85	60	3500	2500	
ERZV14D471				775	50	175	125	6000	4500	
ERZV20D471				775	100	350	250	10000	6500	
ERZV07D511	510 (459-561)	320	410	845	10	45	32	1750	1250	AC 100 to 240 V, Line-Line Applications AC 100 to 240 V, Line-Ground Applications
ERZV09D511				845	25	92	67	3500	2500	
ERZV10D511				845	25	92	67	3500	2500	
ERZV14D511				845	50	190	136	6000	4500	
ERZV20D511				845	100	382	273	10000	6500	
ERZV10D621	620 (558-682)	385	505	1025	25	92	67	3500	2500	
ERZV14D621				1025	50	190	136	5000	4500	
ERZV20D621				1025	100	382	273	7500	6500	
ERZV10D681	680 (612-748)	420	560	1120	25	92	67	3500	2500	
ERZV14D681				1120	50	190	136	5000	4500	
ERZV20D681				1120	100	382	273	7500	6500	
ERZV10D751	750 (675-825)	460	615	1240	25	100	70	3500	2500	AC 380 V, Line-Line and Line-Ground Applications (For DC 500 V Insulating Test)
ERZV14D751				1240	50	210	150	5000	4500	
ERZV20D751				1240	100	420	300	7500	6500	
ERZV10D821	820 (738-902)	510	670	1355	25	110	80	3500	2500	
ERZV14D821				1355	50	235	165	5000	4500	
ERZV20D821				1355	100	460	325	7500	6500	
ERZV10D911	910 (819-1001)	550	745	1500	25	130	90	3500	2500	AC 415 V, Line-Line and Line-Ground Applications (For DC 500 V Insulating Test)
ERZV14D911				1500	50	255	180	5000	4500	
ERZV20D911				1500	100	510	360	7500	6500	
ERZV10D102	1000 (900-1100)	625	825	1650	25	140	100	3500	2500	AC 480 V, Line-Line and Line-Ground Applications (For DC 500 V Insulating Test)
ERZV14D102				1650	50	280	200	5000	4500	
ERZV20D102				1650	100	565	400	7500	6500	
ERZV10D112	1100 (990-1210)	680	895	1815	25	155	110	3500	2500	
ERZV14D112				1815	50	310	220	5000	4500	
ERZV20D112				1815	100	620	440	7500	6500	
ERZV10D182CS	1800 (1700-1980)	1000	1465	2970	25	247	183	3500	2500	Line-Ground Applications (For AC 1200 V Withstanding Test)
ERZV14D182CS				2970	50	510	360	5000	4500	
ERZV20D182				2970	100	1020	720	7500	6500	

* Measuring Current of Varistor Voltage 5 Series : 0.1 mA, Others: 1 mA

Design and specifications are each subject to change without notice. Ask factory for the current technical specifications before purchase and/or use. Should a safety concern arise regarding this product, please be sure to contact us immediately.

00 Sep. 2010

5 Series

■ Ratings and Characteristics

● Operating Temperature Range : -40 to 85 °C ● Storage Temperature Range : -40 to 125 °C

Part No.	Varistor Voltage	Maximum Allowable Voltage		Clamping Voltage (max.) **Ip	Rated Power	Maximum Energy		Maximum Peak Current (8/20 μs)		Capacitance (max.) @1 kHz (pF)
						(10/1000 μs)	(2 ms)	1 time	2 times	
	V _{0.1 mA} (V)	ACrms (V)	DC (V)	(V)	(W)	(J)	(J)	(A)	(A)	
ERZV05D180	18(16 to 20)	11	14	40	0.01	0.6	0.4	250	125	1600
ERZV05D220	22(20 to 24)	14	18	48	0.01	0.7	0.5	250	125	1500
ERZV05D270	27(24 to 30)	17	22	60	0.01	0.9	0.7	250	125	1450
ERZV05D330	33(30 to 36)	20	26	73	0.01	1.1	0.8	250	125	1400
ERZV05D390	39(35 to 43)	25	31	86	0.01	1.2	0.9	250	125	700
ERZV05D470	47(42 to 52)	30	38	104	0.01	1.5	1.1	250	125	650
ERZV05D560	56(50 to 62)	35	45	123	0.01	1.8	1.3	250	125	600
ERZV05D680	68(61 to 75)	40	56	150	0.01	2.2	1.6	250	125	580
ERZV05D820	82(74 to 90)	50	65	145	0.1	3.5	2.5	800	600	460
ERZV05D101	100(90 to 110)	60	85	175	0.1	4.0	3.0	800	600	400
ERZV05D121	120(108 to 132)	75	100	210	0.1	5.0	3.5	800	600	350
ERZV05D151	150(135 to 165)	95	125	260	0.1	6.5	4.5	800	600	300
ERZV05D201	200(185 to 225)	130	170	355	0.1	8.5	6.0	800	600	120
ERZV05D221	220(198 to 242)	140	180	380	0.1	9.0	6.5	800	600	110
ERZV05D241	240(216 to 264)	150	200	415	0.1	10.5	7.5	800	600	100
ERZV05D271	270(247 to 303)	175	225	475	0.1	11.0	8.0	800	600	90*
ERZV05D331	330(297 to 363)	210	270	570	0.1	13.0	9.5	800	600	80*
ERZV05D361	360(324 to 396)	230	300	620	0.1	16.0	11.0	800	600	80*
ERZV05D391	390(351 to 429)	250	320	675	0.1	17.0	12.0	800	600	80*
ERZV05D431	430(387 to 473)	275	350	745	0.1	20.0	13.5	800	600	70*
ERZV05D471	470(423 to 517)	300	385	810	0.1	21.0	15.0	800	600	60*

* Measured at 1 MHz **Ip Measuring current of clamping voltage 180 to 680 : 1 A, 820 to 471 : 5 A

■ Dimensions in mm (not to scale) * Refer to page 320 to 321 about leads cut type and taping.

Part No.	D max.	T max.	W±1.0	H max.	L±1.0
ERZV05D180	7.0	4.5	5.0	10.0	1.5
ERZV05D220	7.0	4.5	5.0	10.0	1.5
ERZV05D270	7.0	4.5	5.0	10.0	1.5
ERZV05D330	7.0	4.5	5.0	10.0	1.5
ERZV05D390	7.0	4.5	5.0	10.0	1.5
ERZV05D470	7.0	4.5	5.0	10.0	1.5
ERZV05D560	7.0	4.5	5.0	10.0	1.5
ERZV05D680	7.0	4.5	5.0	10.0	1.5
ERZV05D820	7.0	4.1	5.0	10.0	1.4
ERZV05D101	7.0	4.3	5.0	10.0	1.6
ERZV05D121	7.0	4.5	5.0	10.0	1.8
ERZV05D151	7.0	4.8	5.0	10.0	2.1
ERZV05D201	7.0	4.4	5.0	10.0	1.7
ERZV05D221	7.0	4.5	5.0	10.0	1.8
ERZV05D241	7.0	4.6	5.0	10.0	1.9
ERZV05D271	7.0	4.8	5.0	10.0	2.1
ERZV05D331	7.0	5.1	5.0	10.0	2.4
ERZV05D361	7.0	5.3	5.0	10.0	2.5
ERZV05D391	7.0	5.4	5.0	10.0	2.7
ERZV05D431	7.0	5.6	5.0	10.0	2.9
ERZV05D471	7.0	5.8	5.0	10.0	3.1



Design and specifications are each subject to change without notice. Ask factory for the current technical specifications before purchase and/or use. Should a safety concern arise regarding this product, please be sure to contact us immediately.

00 Sep. 2010

Typical Characteristics Voltage vs. Current

Impulse Derating (Relation between impulse width and impulse current multiple)

ERZV05D180 to ERZV05D680

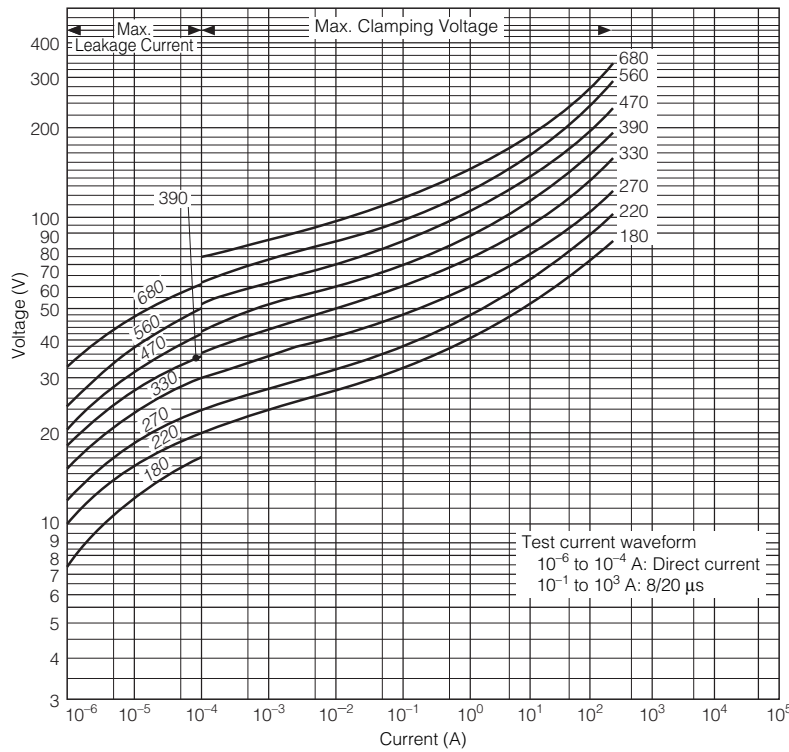

ERZV05D180 to ERZV05D680



ERZV05D820 to ERZV05D471



ERZV05D820 to ERZV05D471

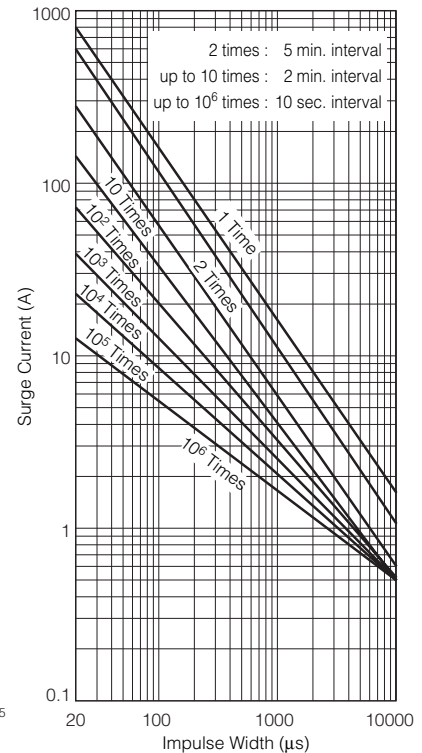

Design and specifications are each subject to change without notice. Ask factory for the current technical specifications before purchase and/or use. Should a safety concern arise regarding this product, please be sure to contact us immediately.

7 Series

■ Ratings and Characteristics

● Operating Temperature Range: -40 to 85 °C ● Storage Temperature Range: -40 to 125 °C

Part No.	Varistor Voltage	Maximum Allowable Voltage		Clamping Voltage (max.) **I _p	Rated Power	Maximum Energy		Maximum Peak Current (8/20 μs)		Capacitance (max.) @1 kHz (pF)
						(10/1000 μs)	(2 ms)	1 time	2 times	
	V _{1 mA} (V)	ACrms (V)	DC (V)	(V)	(W)	(J)	(J)	(A)	(A)	
ERZV07D180	18(16 to 20)	11	14	36	0.02	1.1	0.9	500	250	3800
ERZV07D220	22(20 to 24)	14	18	43	0.02	1.3	1.1	500	250	3600
ERZV07D270	27(24 to 30)	17	22	53	0.02	1.6	1.3	500	250	3400
ERZV07D330	33(30 to 36)	20	26	65	0.02	2.0	1.6	500	250	2900
ERZV07D390	39(35 to 43)	25	31	77	0.02	2.4	1.9	500	250	1600
ERZV07D470	47(42 to 52)	30	38	93	0.02	2.8	2.3	500	250	1550
ERZV07D560	56(50 to 62)	35	45	110	0.02	3.4	2.7	500	250	1500
ERZV07D680	68(61 to 75)	40	56	135	0.02	4.1	3.3	500	250	1200
ERZV07D820	82(74 to 90)	50	65	135	0.25	7	5	1750	1250	810
ERZV07D101	100(90 to 110)	60	85	165	0.25	8.5	6	1750	1250	700
ERZV07D121	120(108 to 132)	75	100	200	0.25	10	7	1750	1250	590
ERZV07D151	150(135 to 165)	95	125	250	0.25	13	9	1750	1250	500
ERZV07D201	200(185 to 225)	130	170	340	0.25	17.5	12.5	1750	1250	200
ERZV07D221	220(198 to 242)	140	180	360	0.25	19	13.5	1750	1250	190
ERZV07D241	240(216 to 264)	150	200	395	0.25	21	15	1750	1250	170
ERZV07D271	270(247 to 303)	175	225	455	0.25	24	17	1750	1250	150
ERZV07D331	330(297 to 363)	210	270	545	0.25	28	20	1750	1250	130
ERZV07D361	360(324 to 396)	230	300	595	0.25	32	23	1750	1250	130
ERZV07D391	390(351 to 429)	250	320	650	0.25	35	25	1750	1250	130
ERZV07D431	430(387 to 473)	275	350	710	0.25	40	27.5	1750	1250	120
ERZV07D471	470(423 to 517)	300	385	775	0.25	42	30	1750	1250	100
ERZV07D511	510(459 to 561)	320	410	845	0.25	45	32	1750	1250	90*

* Measured at 1 MHz **I_p Measuring current of clamping voltage 180 to 680 : 25 A, 820 tp 511 : 10 A

■ Dimensions in mm (not to scale) * Refer to page 320 to 321 about leads cut type and taping.

Part No.	D max.	T max.	W±1.0	H max.	L±1.0
ERZV07D180	8.5	4.5	5.0	11.5	1.3
ERZV07D220	8.5	4.6	5.0	11.5	1.4
ERZV07D270	8.5	4.7	5.0	11.5	1.5
ERZV07D330	8.5	4.9	5.0	11.5	1.7
ERZV07D390	8.5	4.8	5.0	11.5	1.6
ERZV07D470	8.5	4.9	5.0	11.5	1.7
ERZV07D560	8.5	5.0	5.0	11.5	1.8
ERZV07D680	8.5	5.2	5.0	11.5	2.0
ERZV07D820	8.5	4.1	5.0	11.5	1.4
ERZV07D101	8.5	4.3	5.0	11.5	1.6
ERZV07D121	8.5	4.5	5.0	11.5	1.8
ERZV07D151	8.5	4.8	5.0	11.5	2.1
ERZV07D201	8.5	4.4	5.0	11.5	1.7
ERZV07D221	8.5	4.5	5.0	11.5	1.8
ERZV07D241	8.5	4.6	5.0	11.5	1.9
ERZV07D271	8.5	4.8	5.0	11.5	2.1
ERZV07D331	8.5	5.1	5.0	11.5	2.4
ERZV07D361	8.5	5.3	5.0	11.5	2.5
ERZV07D391	8.5	5.4	5.0	11.5	2.7
ERZV07D431	8.5	5.6	5.0	11.5	2.9
ERZV07D471	8.5	5.8	5.0	11.5	3.1
ERZV07D511	8.5	6.0	5.0	11.5	3.3

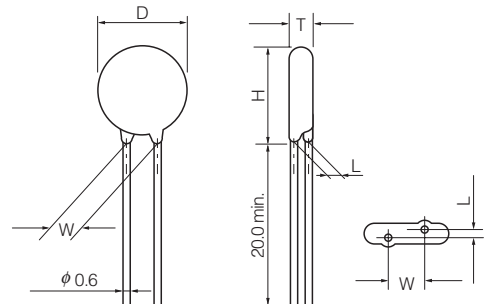

Design and specifications are each subject to change without notice. Ask factory for the current technical specifications before purchase and/or use. Should a safety concern arise regarding this product, please be sure to contact us immediately.

00 Sep. 2010

Typical Characteristics Voltage vs. Current

ERZV07D180 to ERZV07D680

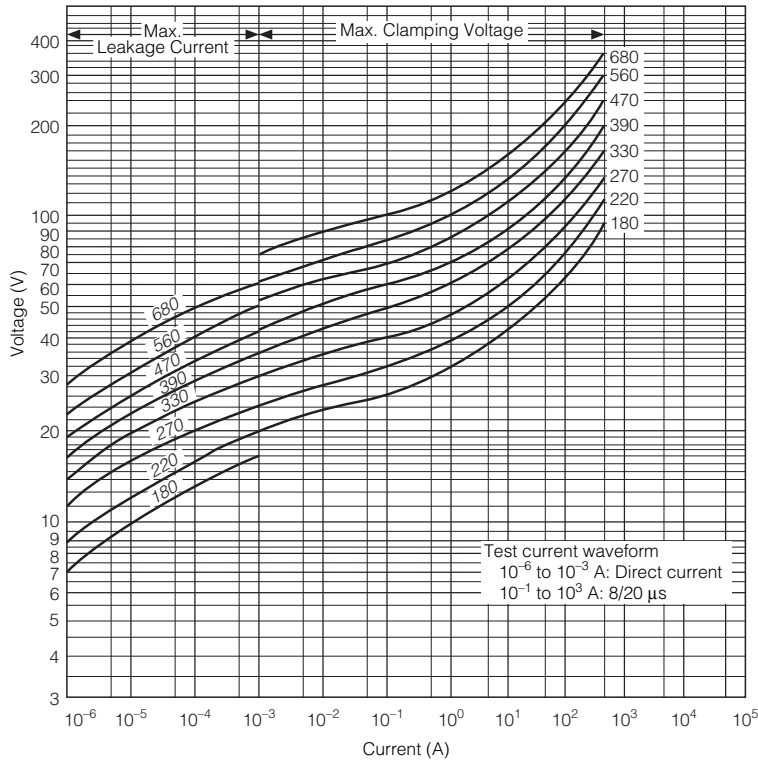

Impulse Derating (Relation between impulse width and impulse current multiple)

ERZV07D180 to ERZV07D680

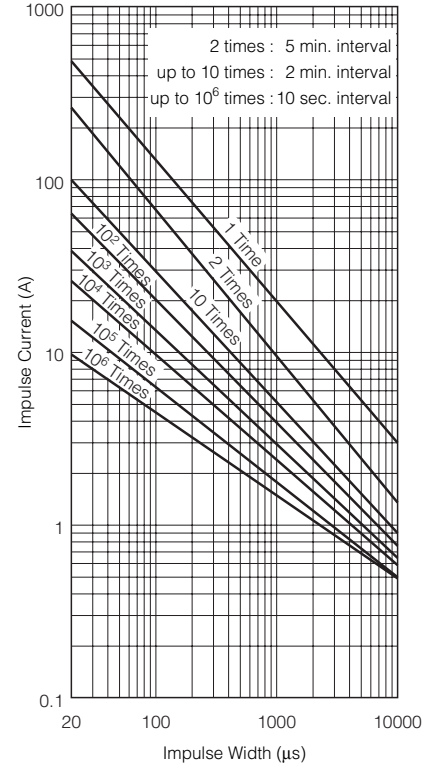

ERZV07D820 to ERZV07D511

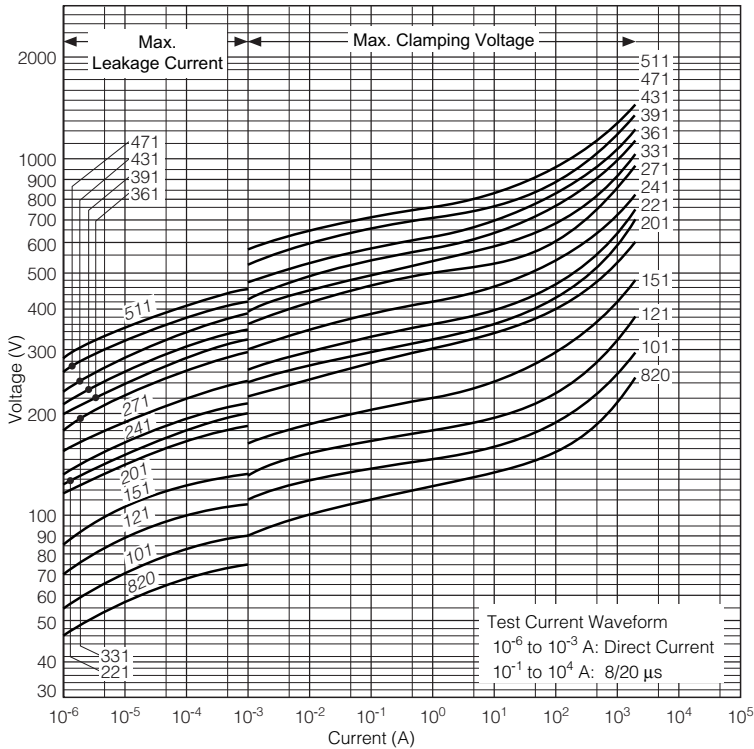

ERZV07D820 to ERZV07D511

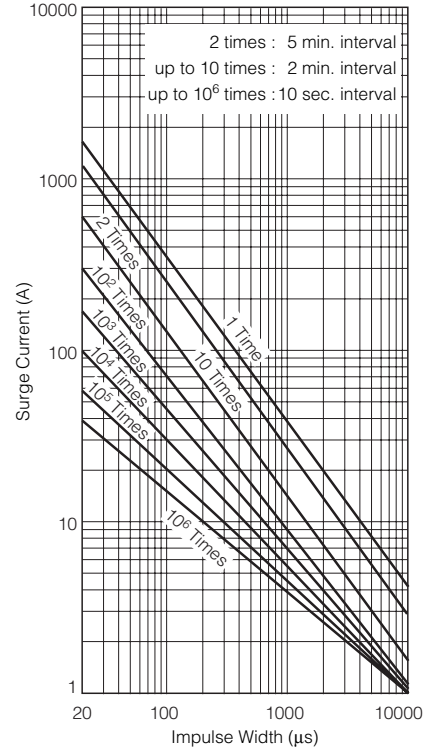

Design and specifications are each subject to change without notice. Ask factory for the current technical specifications before purchase and/or use. Should a safety concern arise regarding this product, please be sure to contact us immediately.

9 Series

■ Ratings and Characteristics

● Operating Temperature Range : -40 to 85 °C ● Storage Temperature Range : -40 to 125 °C

Part No.	Varistor Voltage	Maximum Allowable Voltage		Clamping Voltage (max.) *I _p	Rated Power	Maximum Energy		Maximum Peak Current (8/20 μs)		Capacitance (max.) @1 kHz (pF)
						(10/1000 μs)	(2 ms)	1 time	2 times	
	V _{1mA} (V)	ACrms (V)	DC (V)	(V)	(W)	(J)	(J)	(A)	(A)	
ERZV09D180	18(16 to 20)	11	14	36	0.05	2.6	2.2	1000	500	16000
ERZV09D220	22(20 to 24)	14	18	43	0.05	3.2	2.6	1000	500	11000
ERZV09D270	27(24 to 30)	17	22	53	0.05	3.9	3.2	1000	500	8000
ERZV09D330	33(30 to 36)	20	26	65	0.05	4.8	4.0	1000	500	6300
ERZV09D390	39(35 to 43)	25	31	77	0.05	5.6	4.7	1000	500	5200
ERZV09D470	47(42 to 52)	30	38	93	0.05	6.8	5.6	1000	500	4600
ERZV09D560	56(50 to 62)	35	45	110	0.05	8.1	6.7	1000	500	3750
ERZV09D680	68(61 to 75)	40	56	135	0.05	9.8	8.2	1000	500	2800
ERZV09D820	82(74 to 90)	50	65	135	0.4	14	10	3500	2500	2000
ERZV09D101	100(90 to 110)	60	85	165	0.4	17	12	3500	2500	1700
ERZV09D121	120(108 to 132)	75	100	200	0.4	20	14.5	3500	2500	1400
ERZV09D151	150(135 to 165)	95	125	250	0.4	25	18	3500	2500	1100
ERZV09D201	200(185 to 225)	130	170	340	0.4	35	25	3500	2500	430
ERZV09D221	220(198 to 242)	140	180	360	0.4	39	27.5	3500	2500	410
ERZV09D241	240(216 to 264)	150	200	395	0.4	42	30	3500	2500	380
ERZV09D271	270(247 to 303)	175	225	455	0.4	49	35	3500	2500	350
ERZV09D331	330(297 to 363)	210	270	545	0.4	58	42	3500	2500	300
ERZV09D361	360(324 to 396)	230	300	595	0.4	65	45	3500	2500	300
ERZV09D391	390(351 to 429)	250	320	650	0.4	70	50	3500	2500	300
ERZV09D431	430(387 to 473)	275	350	710	0.4	80	55	3500	2500	270
ERZV09D471	470(423 to 517)	300	385	775	0.4	85	60	3500	2500	230
ERZV09D511	510(459 to 561)	320	410	845	0.4	92	67	3500	2500	210

*I_p Measuring current of clamping voltage 180 to 680 : 5 A, 820 to 511 : 25 A

■ Dimensions in mm (not to scale) * Refer to page 320 to 321 about leads cut type and taping.

Part No.	D max.	T max.	W±1.0	H max.	L±1.0
ERZV09D180	11.5	3.8	5.0	14.0	1.3
ERZV09D220	11.5	4.0	5.0	14.0	1.4
ERZV09D270	11.5	4.2	5.0	14.0	1.5
ERZV09D330	11.5	4.5	5.0	14.0	1.7
ERZV09D390	11.5	4.0	5.0	14.0	1.7
ERZV09D470	11.5	4.2	5.0	14.0	1.8
ERZV09D560	11.5	4.4	5.0	14.0	1.9
ERZV09D680	11.5	4.5	5.0	14.0	2.2
ERZV09D820	11.5	3.8	5.0	14.0	1.6
ERZV09D101	11.5	3.9	5.0	14.0	1.8
ERZV09D121	11.5	4.1	5.0	14.0	2.0
ERZV09D151	11.5	4.4	5.0	14.0	2.2
ERZV09D201	11.5	4.1	5.0	14.0	1.7
ERZV09D221	11.5	4.2	5.0	14.0	1.8
ERZV09D241	11.5	4.3	5.0	14.0	1.9
ERZV09D271	11.5	4.5	5.0	14.0	2.0
ERZV09D331	11.5	4.8	5.0	14.0	2.3
ERZV09D361	11.5	5.0	5.0	14.0	2.5
ERZV09D391	11.5	5.1	5.0	14.0	2.6
ERZV09D431	11.5	5.3	5.0	14.0	2.8
ERZV09D471	11.5	5.6	5.0	14.0	3.1
ERZV09D511	11.5	5.8	5.0	14.0	3.2

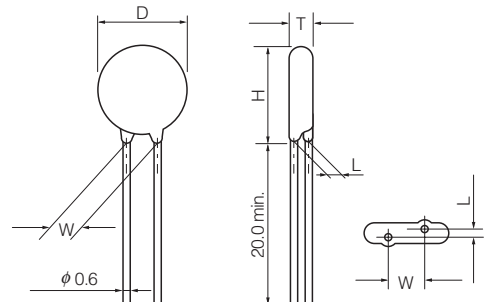

Design and specifications are each subject to change without notice. Ask factory for the current technical specifications before purchase and/or use. Should a safety concern arise regarding this product, please be sure to contact us immediately.

00 Sep. 2010

Typical Characteristics Voltage vs. Current

Impulse Derating (Relation between impulse width and impulse current multiple)

ERZV09D180 to ERZV09D680

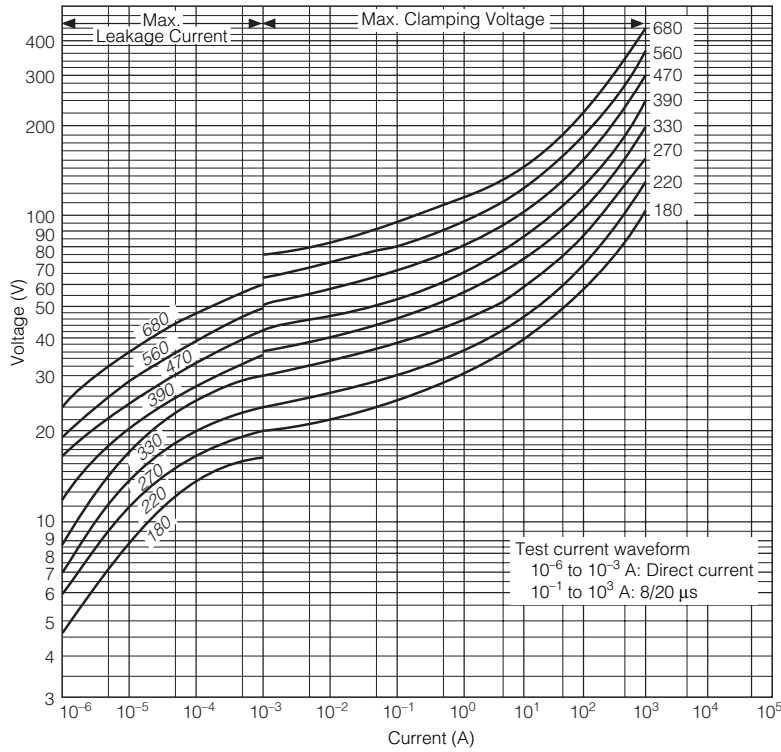

ERZV09D180 to ERZV09D680

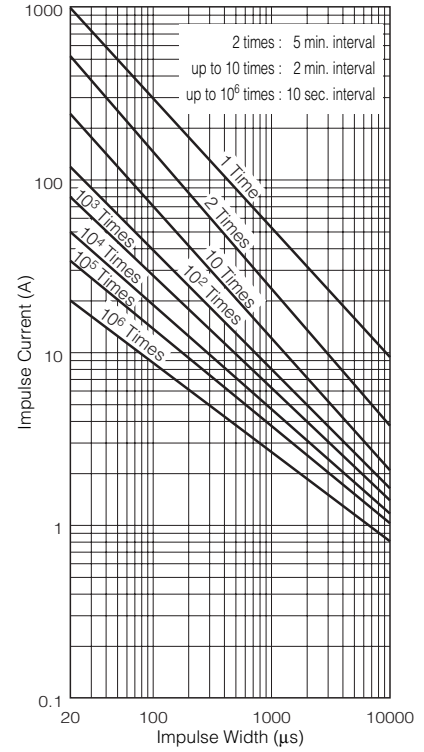

ERZV09D820 to ERZV09D511

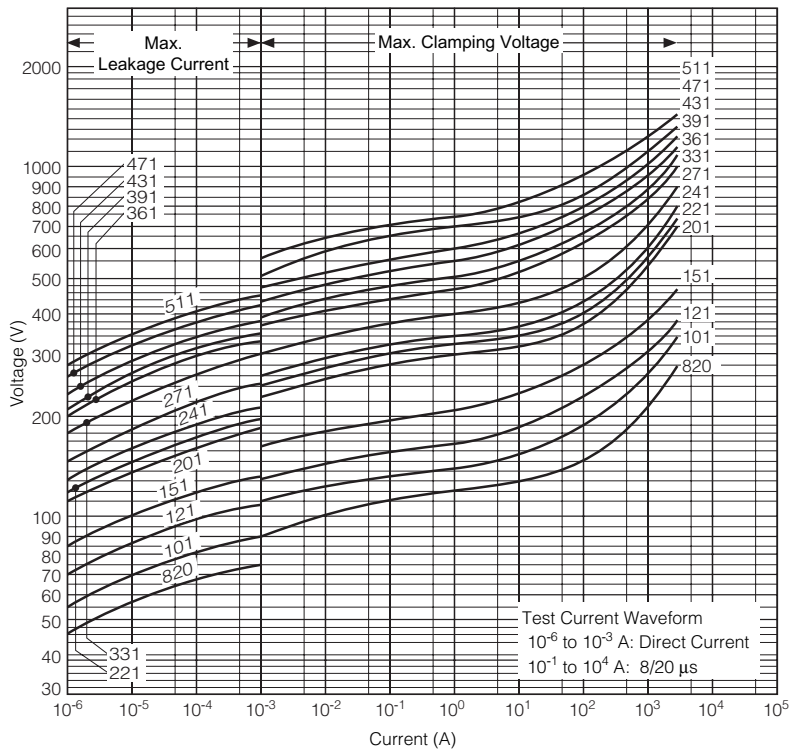

ERZV09D820 to ERZV09D511



Design and specifications are each subject to change without notice. Ask factory for the current technical specifications before purchase and/or use. Should a safety concern arise regarding this product, please be sure to contact us immediately.

10 Series

■ Ratings and Characteristics

● Operating Temperature Range : -40 to 85 °C ● Storage Temperature Range : -40 to 125 °C

Part No.	Varistor Voltage	Maximum Allowable Voltage		Clamping Voltage (max.) **I _p	Rated Power	Maximum Energy		Maximum Peak Current (8/20 μs)		Capacitance (max.) @1 kHz (pF)
						(10/1000 μs)	(2 ms)	1 time	2 times	
						V _{1 mA} (V)	ACrms (V)	DC (V)	(V)	
ERZV10D180	18(16 to 20)	11	14	36	0.05	2.6	2.2	1000	500	16000
ERZV10D220	22(20 to 24)	14	18	43	0.05	3.2	2.6	1000	500	11000
ERZV10D270	27(24 to 30)	17	22	53	0.05	3.9	3.2	1000	500	8000
ERZV10D330	33(30 to 36)	20	26	65	0.05	4.8	4.0	1000	500	6300
ERZV10D390	39(35 to 43)	25	31	77	0.05	5.6	4.7	1000	500	5200
ERZV10D470	47(42 to 52)	30	38	93	0.05	6.8	5.6	1000	500	4600
ERZV10D560	56(50 to 62)	35	45	110	0.05	8.1	6.7	1000	500	3750
ERZV10D680	68(61 to 75)	40	56	135	0.05	9.8	8.2	1000	500	2800
ERZV10D820	82(74 to 90)	50	65	135	0.4	14	10	3500	2500	2000
ERZV10D101	100(90 to 110)	60	85	165	0.4	17	12	3500	2500	1700
ERZV10D121	120(108 to 132)	75	100	200	0.4	20	14.5	3500	2500	1400
ERZV10D151	150(135 to 165)	95	125	250	0.4	25	18	3500	2500	1100
ERZV10D201	200(185 to 225)	130	170	340	0.4	35	25	3500	2500	430
ERZV10D221	220(198 to 242)	140	180	360	0.4	39	27.5	3500	2500	410
ERZV10D241	240(216 to 264)	150	200	395	0.4	42	30	3500	2500	380
ERZV10D271	270(247 to 303)	175	225	455	0.4	49	35	3500	2500	350
ERZV10D331	330(297 to 363)	210	270	545	0.4	58	42	3500	2500	300
ERZV10D361	360(324 to 396)	230	300	595	0.4	65	45	3500	2500	300
ERZV10D391	390(351 to 429)	250	320	650	0.4	70	50	3500	2500	300
ERZV10D431	430(387 to 473)	275	350	710	0.4	80	55	3500	2500	270
ERZV10D471	470(423 to 517)	300	385	775	0.4	85	60	3500	2500	230
ERZV10D511	510(459 to 561)	320	410	845	0.4	92	67	3500	2500	210
ERZV10D621	620(558 to 682)	385	505	1025	0.4	92	67	3500	2500	190
ERZV10D681	680(612 to 748)	420	560	1120	0.4	92	67	3500	2500	170
ERZV10D751	750(675 to 825)	460	615	1240	0.4	100	70	3500	2500	160
ERZV10D821	820(738 to 902)	510	670	1355	0.4	110	80	3500	2500	140
ERZV10D911	910(819 to 1001)	550	745	1500	0.4	130	90	3500	2500	120
ERZV10D102	1000(900 to 1100)	625	825	1650	0.4	140	100	3500	2500	110
ERZV10D112	1100(990 to 1210)	680	895	1815	0.4	155	110	3500	2500	110
ERZV10D182CS	1800(1700 to 1980)	1000	1465	2970	0.4	247	183	3500	2500	70*

* Measured at 1 MHz **I_p Measuring current of clamping voltage 180 to 680 : 5 A, 820 to 182 : 25 A

■ Dimensions in mm (not to scale) * Refer to page 320 to 321 about leads cut type and taping.

Part No.	D max.	T max.	W±1.0	H max.	L±1.0
ERZV10D180	11.5	4.6	7.5	14.5	1.3
ERZV10D220	11.5	4.7	7.5	14.5	1.4
ERZV10D270	11.5	4.8	7.5	14.5	1.5
ERZV10D330	11.5	5.0	7.5	14.5	1.7
ERZV10D390	11.5	4.9	7.5	14.5	1.6
ERZV10D470	11.5	5.0	7.5	14.5	1.7
ERZV10D560	11.5	5.1	7.5	14.5	1.8
ERZV10D680	11.5	5.3	7.5	14.5	2.0
ERZV10D820	11.5	4.5	7.5	14.5	1.6
ERZV10D101	11.5	4.7	7.5	14.5	1.8
ERZV10D121	11.5	4.9	7.5	14.5	2.0
ERZV10D151	11.5	5.2	7.5	14.5	2.3
ERZV10D201	11.5	4.8	7.5	14.5	1.9
ERZV10D221	11.5	4.9	7.5	14.5	2.0
ERZV10D241	11.5	5.0	7.5	14.5	2.1
ERZV10D271	11.5	5.2	7.5	14.5	2.3
ERZV10D331	11.5	5.5	7.5	14.5	2.6
ERZV10D361	11.5	5.7	7.5	14.5	2.8
ERZV10D391	11.5	5.8	7.5	14.5	2.9
ERZV10D431	11.5	6.0	7.5	14.5	3.1
ERZV10D471	11.5	6.2	7.5	14.5	3.3
ERZV10D511	11.5	6.4	7.5	14.5	3.5
ERZV10D621	12.5	7.1	7.5	15.5	4.2
ERZV10D681	12.5	7.4	7.5	15.5	4.5
ERZV10D751	12.5	7.8	7.5	15.5	4.9
ERZV10D821	12.5	8.1	7.5	15.5	5.2
ERZV10D911	12.5	8.6	7.5	15.5	5.7
ERZV10D102	12.5	9.1	7.5	15.5	6.2
ERZV10D112	12.5	9.7	7.5	15.5	6.8
ERZV10D182CS	13.5	14.4	11.0*	16.5	10.0(±1.5)

*: W₂



(ERZV10D182CS)

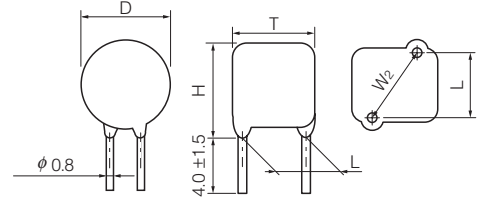

■ Typical Characteristics

Voltage vs. Current

ERZV10D180 to ERZV10D680



Impulse Derating (Relation between impulse width and impulse current multiple)

ERZV10D180 to ERZV10D680



Design and specifications are each subject to change without notice. Ask factory for the current technical specifications before purchase and/or use. Should a safety concern arise regarding this product, please be sure to contact us immediately.

00 Sep. 2010

Typical Characteristics Voltage vs. Current

ERZV10D820 to ERZV10D511

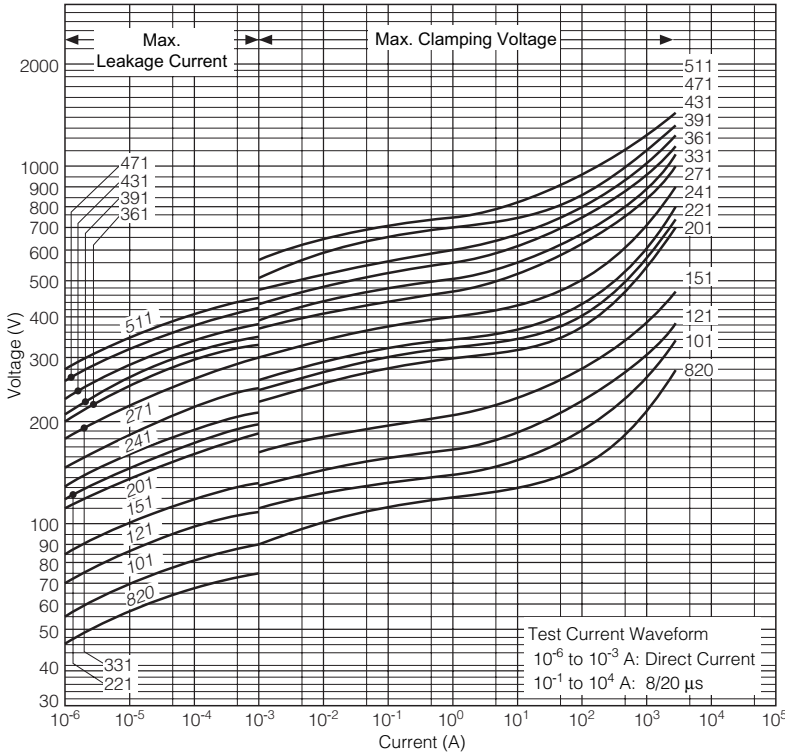

Impulse Derating (Relation between impulse width and impulse current multiple)

ERZV10D820 to ERZV10D511

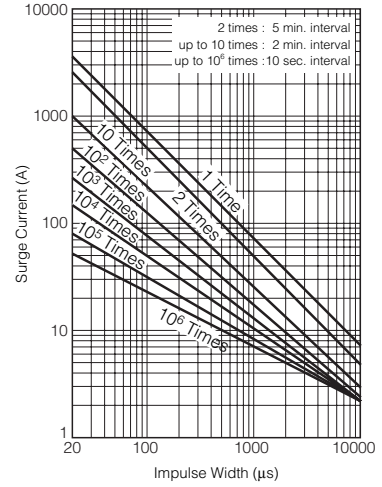

ERZV10D621 to ERZV10D112

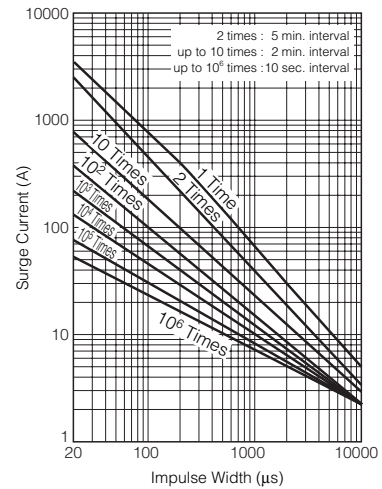

ERZV10D621 to ERZV10D182CS

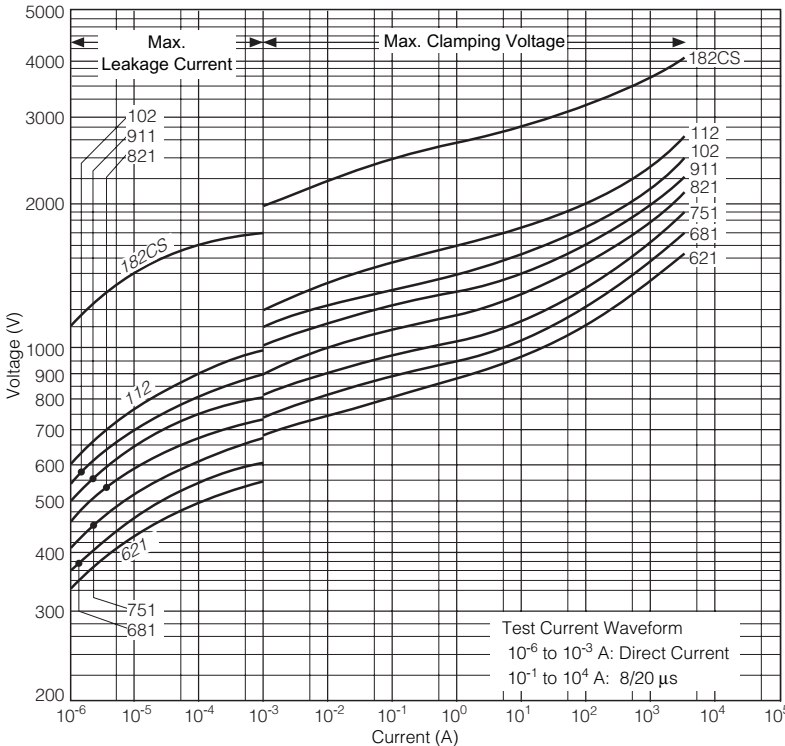

ERZV10D182CS

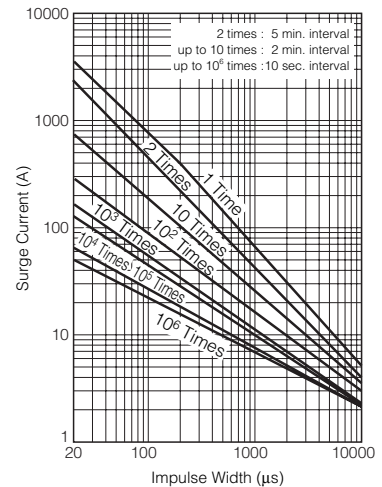

Design and specifications are each subject to change without notice. Ask factory for the current technical specifications before purchase and/or use. Should a safety concern arise regarding this product, please be sure to contact us immediately.

14 Series

■ Ratings and Characteristics

● Operating Temperature Range : -40 to 85 °C ● Storage Temperature Range : -40 to 125 °C

Part No.	Varistor Voltage	Maximum Allowable Voltage		Clamping Voltage (max.) *I _p	Rated Power	Maximum Energy		Maximum Peak Current (8/20 μs)		Capacitance (max.) @1 kHz (pF)
						(10/1000 μs)	(2 ms)	1 time	2 times	
						(V)	(W)	(J)	(J)	
ERZV14D180	18(16 to 20)	11	14	36	0.1	5.2	4.3	2000	1000	25000
ERZV14D220	22(20 to 24)	14	18	43	0.1	6.3	5.3	2000	1000	20000
ERZV14D270	27(24 to 30)	17	22	53	0.1	7.8	6.5	2000	1000	16000
ERZV14D330	33(30 to 36)	20	26	65	0.1	9.5	7.9	2000	1000	12200
ERZV14D390	39(35 to 43)	25	31	77	0.1	11	9.4	2000	1000	7000
ERZV14D470	47(42 to 52)	30	38	93	0.1	14	11	2000	1000	6750
ERZV14D560	56(50 to 62)	35	45	110	0.1	16	13	2000	1000	6500
ERZV14D680	68(61 to 75)	40	56	135	0.1	20	16	2000	1000	5500
ERZV14D820	82(74 to 90)	50	65	135	0.6	28	20	6000	5000	3700
ERZV14D101	100(90 to 110)	60	85	165	0.6	35	25	6000	5000	3200
ERZV14D121	120(108 to 132)	75	100	200	0.6	42	30	6000	5000	2700
ERZV14D151	150(135 to 165)	95	125	250	0.6	53	37.5	6000	5000	2200
ERZV14D201	200(185 to 225)	130	170	340	0.6	70	50	6000	5000	770
ERZV14D221	220(198 to 242)	140	180	360	0.6	78	55	6000	5000	740
ERZV14D241	240(216 to 264)	150	200	395	0.6	84	60	6000	5000	700
ERZV14D271	270(247 to 303)	175	225	455	0.6	99	70	6000	5000	640
ERZV14D331	330(297 to 363)	210	270	545	0.6	115	80	6000	4500	580
ERZV14D361	360(324 to 396)	230	300	595	0.6	130	90	6000	4500	540
ERZV14D391	390(351 to 429)	250	320	650	0.6	140	100	6000	4500	500
ERZV14D431	430(387 to 473)	275	350	710	0.6	155	110	6000	4500	450
ERZV14D471	470(423 to 517)	300	385	775	0.6	175	125	6000	4500	400
ERZV14D511	510(459 to 561)	320	410	845	0.6	190	136	6000	4500	350
ERZV14D621	620(558 to 682)	385	505	1025	0.6	190	136	5000	4500	330
ERZV14D681	680(612 to 748)	420	560	1120	0.6	190	136	5000	4500	320
ERZV14D751	750(675 to 825)	460	615	1240	0.6	210	150	5000	4500	310
ERZV14D821	820(738 to 902)	510	670	1355	0.6	235	165	5000	4500	280
ERZV14D911	910(819 to 1001)	550	745	1500	0.6	255	180	5000	4500	250
ERZV14D102	1000(900 to 1100)	625	825	1650	0.6	280	200	5000	4500	230
ERZV14D112	1100(990 to 1210)	680	895	1815	0.6	310	220	5000	4500	210
ERZV14D182CS	1800(1700 to 1980)	1000	1465	2970	0.6	510	360	5000	4500	120

*I_p Measuring current of clamping voltage 180 to 680 : 10 A, 820 to 182 : 50 A

■ Dimensions in mm (not to scale) * Refer to page 320 to 321 about leads cut type and taping.

Part No.	D max.	T max.	W±1.0	H max.	L±1.0
ERZV14D180	15.5	4.6	7.5	18.5	1.3
ERZV14D220	15.5	4.7	7.5	18.5	1.4
ERZV14D270	15.5	4.8	7.5	18.5	1.5
ERZV14D330	15.5	5.0	7.5	18.5	1.7
ERZV14D390	15.5	4.9	7.5	18.5	1.6
ERZV14D470	15.5	5.0	7.5	18.5	1.7
ERZV14D560	15.5	5.1	7.5	18.5	1.8
ERZV14D680	15.5	5.3	7.5	18.5	2.0
ERZV14D820	15.5	4.5	7.5	18.5	1.6
ERZV14D101	15.5	4.7	7.5	18.5	1.8
ERZV14D121	15.5	4.9	7.5	18.5	2.0
ERZV14D151	15.5	5.2	7.5	18.5	2.3
ERZV14D201	15.5	4.8	7.5	18.5	1.9
ERZV14D221	15.5	4.9	7.5	18.5	2.0
ERZV14D241	15.5	5.0	7.5	18.5	2.1
ERZV14D271	15.5	5.2	7.5	18.5	2.3
ERZV14D331	15.5	5.5	7.5	18.5	2.6
ERZV14D361	15.5	5.7	7.5	18.5	2.8
ERZV14D391	15.5	5.8	7.5	18.5	2.9
ERZV14D431	15.5	6.0	7.5	18.5	3.1
ERZV14D471	15.5	6.2	7.5	18.5	3.3
ERZV14D511	15.5	6.4	7.5	18.5	3.5
ERZV14D621	16.0	7.1	7.5	19.0	4.2
ERZV14D681	16.0	7.4	7.5	19.0	4.5
ERZV14D751	16.0	7.8	7.5	19.0	4.9
ERZV14D821	16.0	8.1	7.5	19.0	5.2
ERZV14D911	16.0	8.6	7.5	19.0	5.7
ERZV14D102	16.0	9.1	7.5	19.0	6.2
ERZV14D112	16.0	9.7	7.5	19.0	6.8
ERZV14D182CS	17.0	14.4	15.0*	20.5	10.5(±2.0)

*: W₂

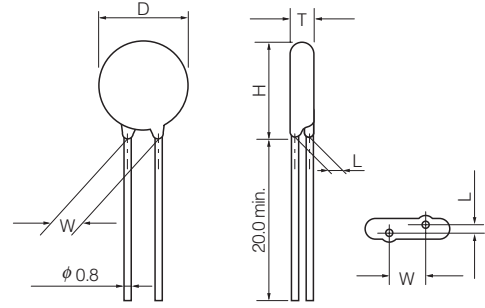

(ERZV14D182CS)

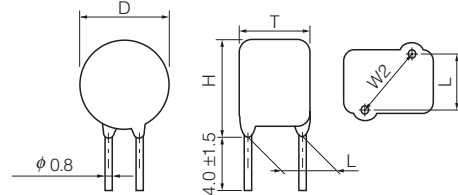

■ Typical Characteristics Voltage vs. Current

ERZV14D180 to ERZV14D680

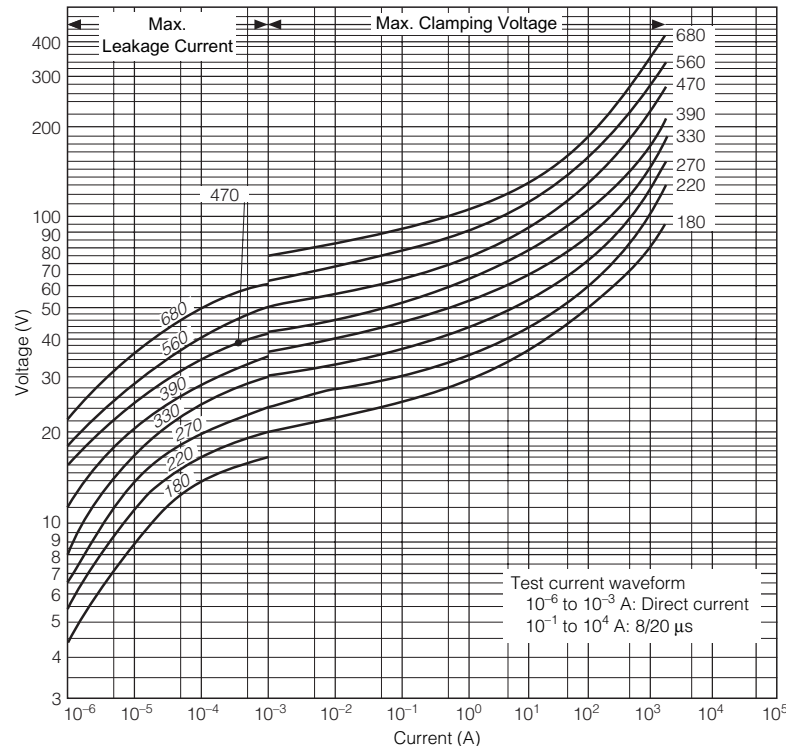

Impulse Derating (Relation between impulse width and impulse current multiple)

ERZV14D180 to ERZV14D680

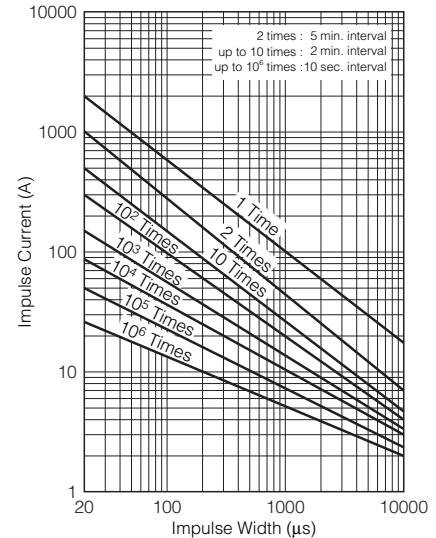

Design and specifications are each subject to change without notice. Ask factory for the current technical specifications before purchase and/or use. Should a safety concern arise regarding this product, please be sure to contact us immediately.

00 Sep. 2010

Typical Characteristics Voltage vs. Current

ERZV14D820 to ERZV14D511

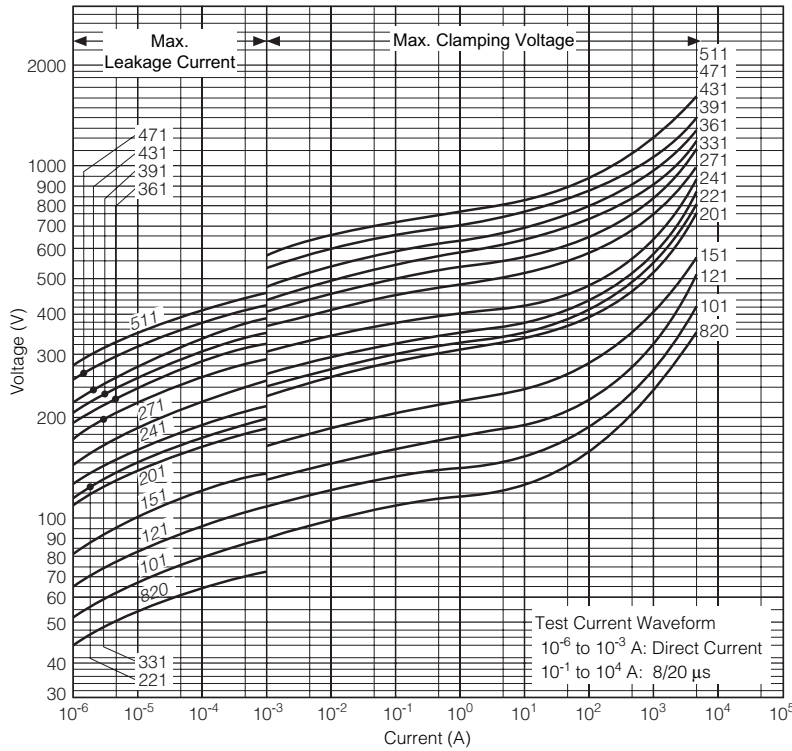

Impulse Derating (Relation between impulse width and impulse current multiple)

ERZV14D820 to ERZV14D511

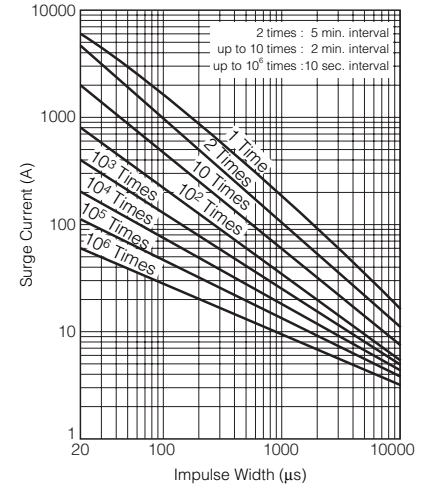

ERZV14D621 to ERZV14D112

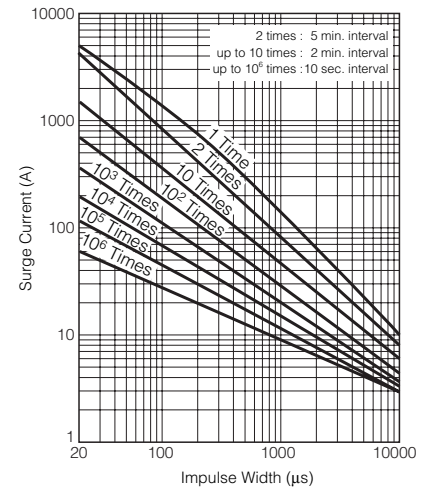

ERZV14D621 to ERZV14D182CS

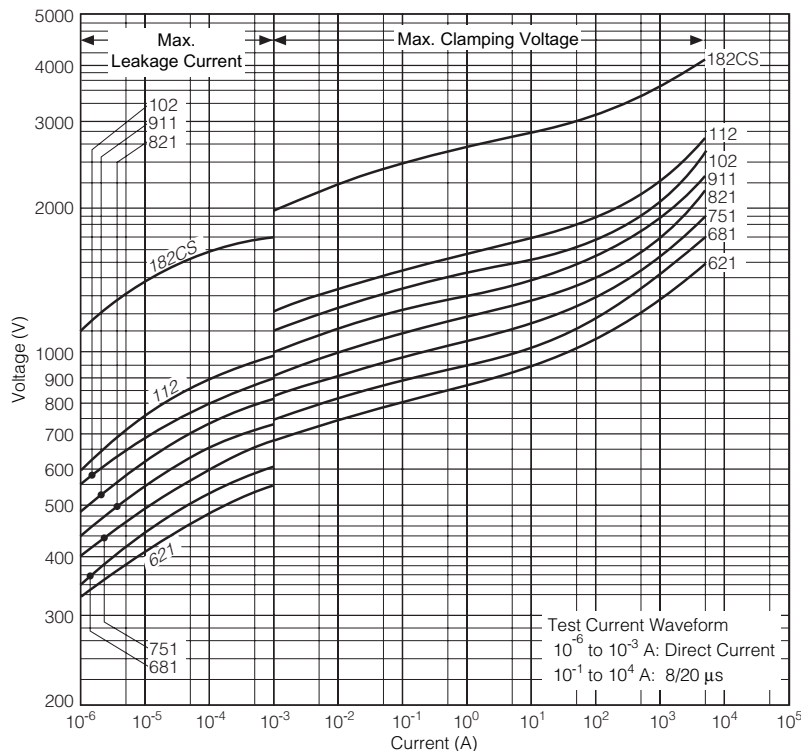

ERZV14D182CS

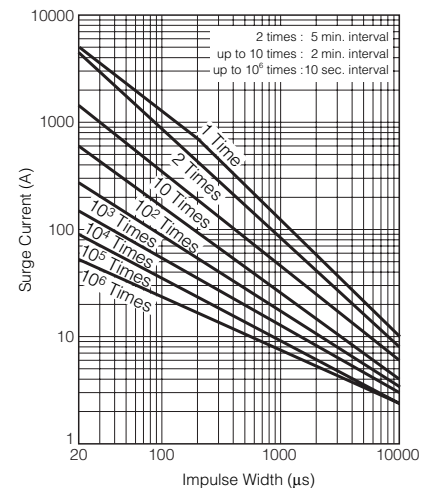

Design and specifications are each subject to change without notice. Ask factory for the current technical specifications before purchase and/or use. Should a safety concern arise regarding this product, please be sure to contact us immediately.

20 Series

■ Ratings and Characteristics

● Operating Temperature Range : -40 to 85 °C ● Storage Temperature Range : -40 to 125 °C

Part No.	Varistor Voltage	Maximum Allowable Voltage		Clamping Voltage (max.) *I _p	Rated Power	Maximum Energy		Maximum Peak Current (8/20 μs)		Capacitance (max.) @1 kHz (pF)
						(10/1000 μs)	(2 ms)	1 time	2 times	
						(J)	(J)	(A)	(A)	
ERZV20D180	18(16 to 20)	11	14	36	0.2	13	12	3000	2000	40000
ERZV20D220	22(20 to 24)	14	18	43	0.2	16	14	3000	2000	30000
ERZV20D270	27(24 to 30)	17	22	53	0.2	19	17	3000	2000	24500
ERZV20D330	33(30 to 36)	20	26	65	0.2	24	21	3000	2000	20000
ERZV20D390	39(35 to 43)	25	31	77	0.2	28	25	3000	2000	13800
ERZV20D470	47(42 to 52)	30	38	93	0.2	34	30	3000	2000	13500
ERZV20D560	56(50 to 62)	35	45	110	0.2	41	36	3000	2000	12200
ERZV20D680	68(61 to 75)	40	56	135	0.2	49	44	3000	2000	11500
ERZV20D820	82(74 to 90)	50	65	135	1.0	56	40	10000	7000	7500
ERZV20D101	100(90 to 110)	60	85	165	1.0	70	50	10000	7000	6500
ERZV20D121	120(108 to 132)	75	100	200	1.0	85	60	10000	7000	5500
ERZV20D151	150(135 to 165)	95	125	250	1.0	106	75	10000	7000	4500
ERZV20D201	200(185 to 225)	130	170	340	1.0	140	100	10000	7000	1700
ERZV20D221	220(198 to 242)	140	180	360	1.0	155	110	10000	7000	1600
ERZV20D241	240(216 to 264)	150	200	395	1.0	168	120	10000	7000	1500
ERZV20D271	270(247 to 303)	175	225	455	1.0	190	135	10000	7000	1300
ERZV20D331	330(297 to 363)	210	270	545	1.0	228	160	10000	6500	1100
ERZV20D361	360(324 to 396)	230	300	595	1.0	255	180	10000	6500	1100
ERZV20D391	390(351 to 429)	250	320	650	1.0	275	195	10000	6500	1100
ERZV20D431	430(387 to 473)	275	350	710	1.0	303	215	10000	6500	1000
ERZV20D471	470(423 to 517)	300	385	775	1.0	350	250	10000	6500	900
ERZV20D511	510(459 to 561)	320	410	845	1.0	382	273	10000	6500	800
ERZV20D621	620(to 558 to 682)	385	505	1025	1.0	382	273	7500	6500	700
ERZV20D681	680(612 to 748)	420	560	1120	1.0	382	273	7500	6500	650
ERZV20D751	750(675 to 825)	460	615	1240	1.0	420	300	7500	6500	600
ERZV20D821	820(738 to 902)	510	670	1355	1.0	460	325	7500	6500	530
ERZV20D911	910(819 to 1001)	550	745	1500	1.0	510	360	7500	6500	500
ERZV20D102	1000(900 to 1100)	625	825	1650	1.0	565	400	7500	6500	450
ERZV20D112	1100(990 to 1210)	680	895	1815	1.0	620	440	7500	6500	400
ERZV20D182	1800(1700 to 1980)	1000	1465	2970	1.0	1020	720	7500	6500	250

*I_p Measuring current of clamping voltage 180 to 680 : 20 A, 820 to 182 : 100 A

■ Dimensions in mm (not to scale) * Refer to page 320 to 321 about leads cut type and taping.

Part No.	D max.	T max.	W±1.0	H max.	L±1.0
ERZV20D180	21.5	5.1	10.0	24.5	1.5
ERZV20D220	21.5	5.2	10.0	24.5	1.6
ERZV20D270	21.5	5.3	10.0	24.5	1.7
ERZV20D330	21.5	5.5	10.0	24.5	1.9
ERZV20D390	21.5	5.5	10.0	24.5	1.9
ERZV20D470	21.5	5.6	10.0	24.5	2.0
ERZV20D560	21.5	5.7	10.0	24.5	2.1
ERZV20D680	21.5	5.8	10.0	24.5	2.2
ERZV20D820	21.5	4.9	10.0	24.5	1.8
ERZV20D101	21.5	5.1	10.0	24.5	2.0
ERZV20D121	21.5	5.3	10.0	24.5	2.2
ERZV20D151	21.5	5.6	10.0	24.5	2.5
ERZV20D201	21.5	5.2	10.0	24.5	2.1
ERZV20D221	21.5	5.3	10.0	24.5	2.2
ERZV20D241	21.5	5.4	10.0	24.5	2.3
ERZV20D271	21.5	5.6	10.0	24.5	2.5
ERZV20D331	21.5	5.9	10.0	24.5	2.8
ERZV20D361	21.5	6.1	10.0	24.5	3.0
ERZV20D391	21.5	6.2	10.0	24.5	3.1
ERZV20D431	21.5	6.4	10.0	24.5	3.3
ERZV20D471	21.5	6.6	10.0	24.5	3.5
ERZV20D511	21.5	6.8	10.0	24.5	3.7
ERZV20D621	22.5	7.5	10.0	25.5	4.4
ERZV20D681	22.5	7.8	10.0	25.5	4.7
ERZV20D751	22.5	8.2	10.0	25.5	5.1
ERZV20D821	22.5	8.5	10.0	25.5	5.4
ERZV20D911	22.5	9.0	10.0	25.5	5.9
ERZV20D102	22.5	9.5	10.0	25.5	6.4
ERZV20D112	22.5	10.1	10.0	25.5	7.0
ERZV20D182	23.5	14.8	15.0*	28.0	10.7(±2.0)

*: W₂

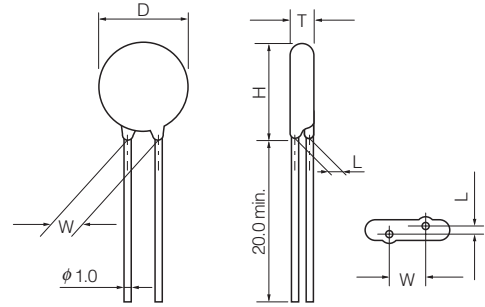

(ERZV20D182)

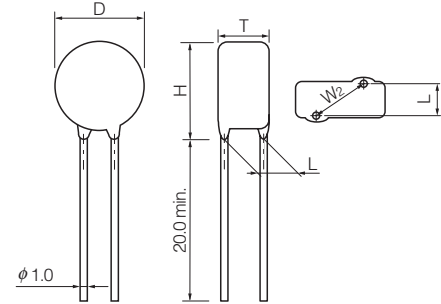

■ Typical Characteristics Voltage vs. Current

ERZV20D180 to ERZV20D680

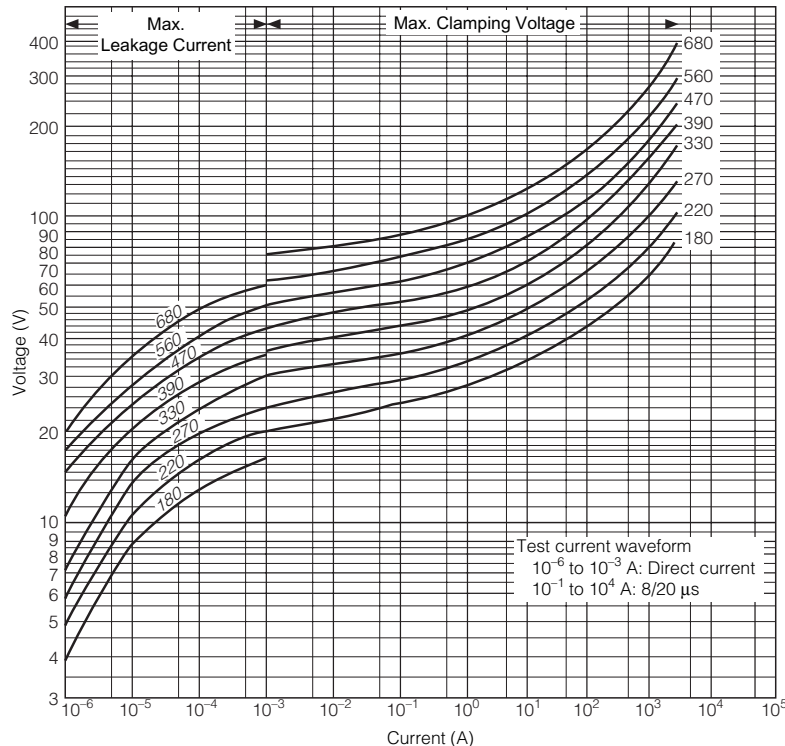

Impulse Derating (Relation between impulse width and impulse current multiple)

ERZV20D180 to ERZV20D680

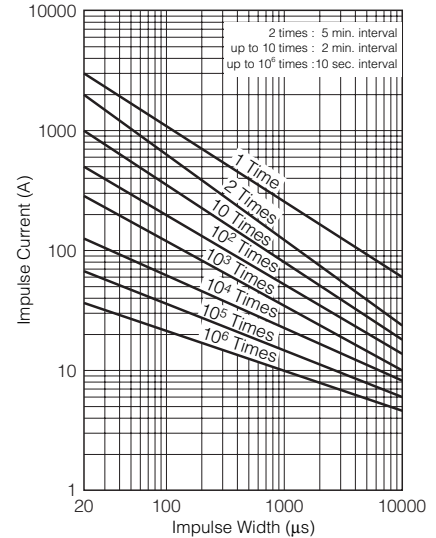

Design and specifications are each subject to change without notice. Ask factory for the current technical specifications before purchase and/or use. Should a safety concern arise regarding this product, please be sure to contact us immediately.

00 Sep. 2010

Typical Characteristics Voltage vs. Current

ERZV20D820 to ERZV20D511

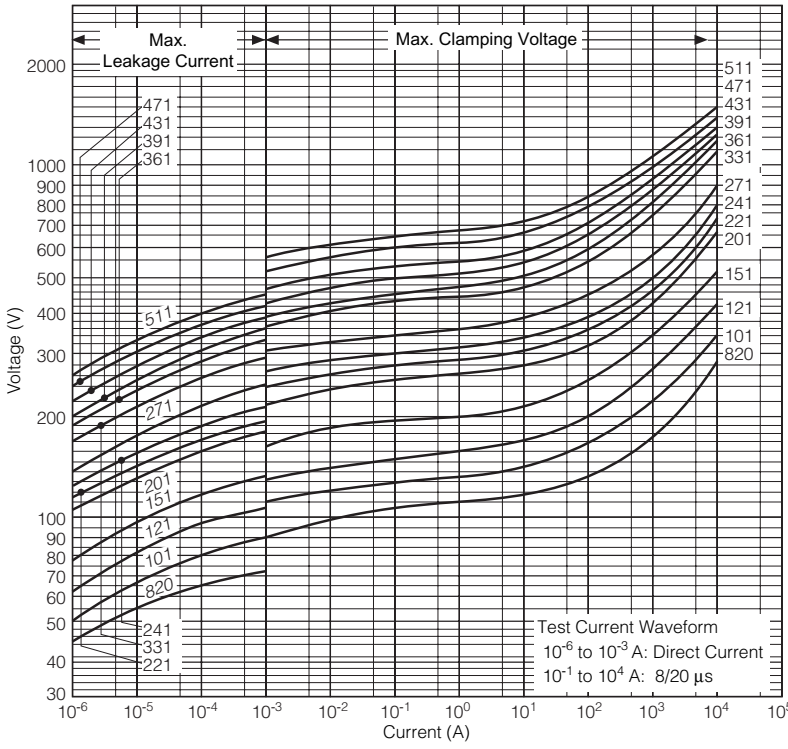

Impulse Derating (Relation between impulse width and impulse current multiple)

ERZV20D820 to ERZV20D511

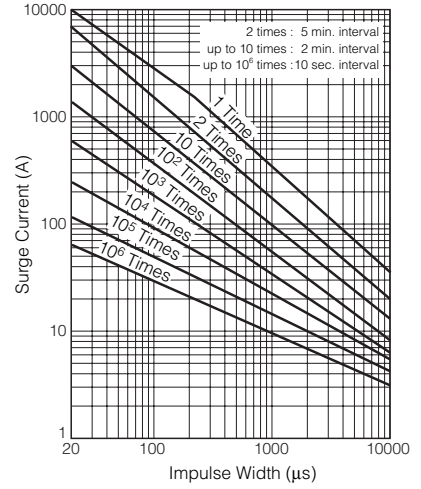

ERZV20D621 to ERZV20D112

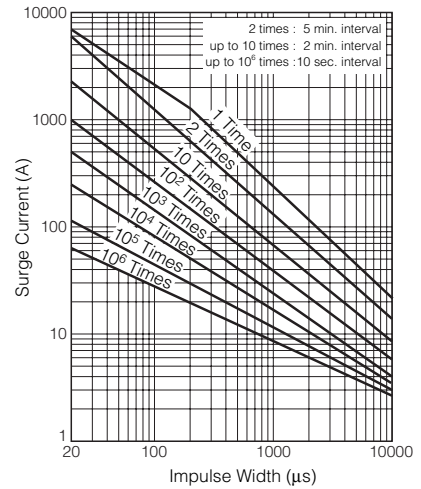

ERZV20D621 to ERZV20D182

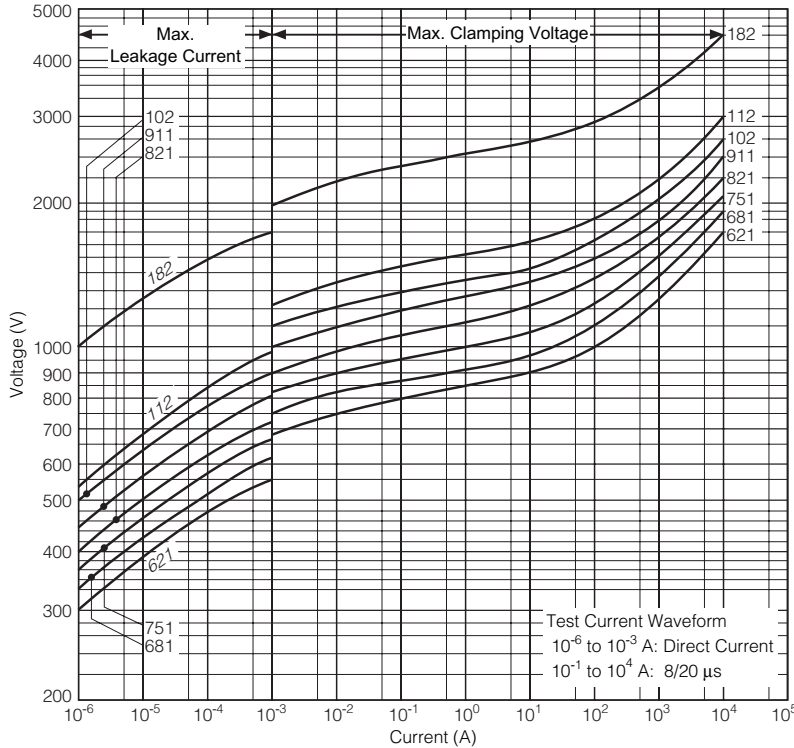

ERZV20D182

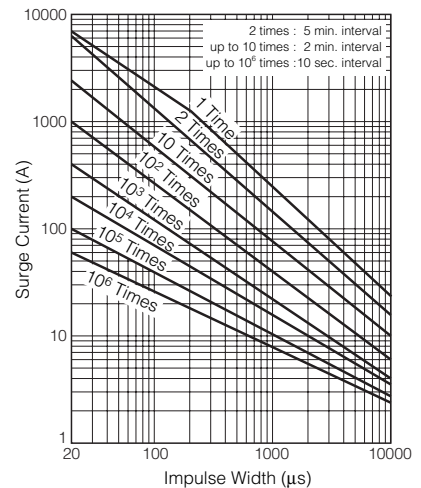

Design and specifications are each subject to change without notice. Ask factory for the current technical specifications before purchase and/or use. Should a safety concern arise regarding this product, please be sure to contact us immediately.