

Safety-door Switch

D4NS

*Multi-contact,
Labor-saving,
Environment-friendly,
Next-generation
Safety-door Switch*

- Lineup includes three contact models with 2NC/1NC and 3NC contact forms in addition to the previous contact forms 1NC/1NO, and 2NC.
- M12-connector models are available, saving on labor and simplifying replacement.
- Standardized gold-clad contacts provide high contact reliability.
- Applicable to both standard loads and micro loads.
- Free of lead, cadmium, and hexavalent chrome, reducing the burden on the environment.



Model Number Structure

Model Number Legend

Switch

D4NS-□□□

1 2 3

1. Conduit/Connector size

- 1: Pg13.5 (1-conduit)
- 2: G1/2 (1-conduit)
- 3: 1/2-14NPT (1-conduit)
- 4: M20 (1-conduit)
- 5: Pg13.5 (2-conduit)
- 6: G1/2 (2-conduit)
- 7: 1/2-14NPT compatible (2-conduit model with M20 conduit size includes an M20-to-1/2-14NPT conversion adapter)
- 8: M20 (2-conduit)
- 9: M12 connector (1-conduit)

2. Built-in Switch

- A: 1NC/1NO (slow-action)
- B: 2NC (slow-action)
- C: 2NC/1NO (slow-action)
- D: 3NC (slow-action)
- E: 1NC/1NO (MBB contact)
- F: 2NC/1NO (MBB contact)

3. Head Mounting Direction

- F: Four mounting directions possible (Front-side mounting at shipping)

Note: An order for the head part or the switch part alone cannot be accepted. The Operation Key is sold separately.

Operation Key

D4DS-K□

1

1. Operation Key Type

- 1: Horizontal mounting
- 2: Vertical mounting
- 3: Adjustable mounting (Horizontal)
- 5: Adjustable mounting (Horizontal/ Vertical)

D4NS

Ordering Information

List of Models

Switches (Operation Keys are sold separately.)



■ : Models with approved direct opening contacts.

Type	Contact configuration	Conduit opening/Connector	Model	
1-conduit	Slow-action	1NC/1NO	Pg13.5	D4NS-1AF (note 3)
			G1/2	D4NS-2AF
			1/2-14NPT	D4NS-3AF
			M20	D4NS-4AF (note 3)
		2NC	Pg13.5	D4NS-1BF (note 3)
			G1/2	D4NS-2BF
			1/2-14NPT	D4NS-3BF
			M20	D4NS-4BF (note 3)
		2NC/1NO	Pg13.5	D4NS-1CF (note 3)
			G1/2	D4NS-2CF
			1/2-14NPT	D4NS-3CF
			M20	D4NS-4CF (note 3)
	3NC	Pg13.5	D4NS-1DF	
		G1/2	D4NS-2DF	
		1/2-14NPT	D4NS-3DF	
		M20	D4NS-4DF (note 3)	
	Slow-action MBB contact	1NC/1NO	Pg13.5	D4NS-1EF
			G1/2	D4NS-2EF
			1/2-14NPT	D4NS-3EF
			M20	D4NS-4EF (note 3)
		2NC/1NO	Pg13.5	D4NS-1FF
			G1/2	D4NS-2FF
			1/2-14NPT	D4NS-3FF
			M20	D4NS-4FF (note 3)
2-conduit	Slow-action	1NC/1NO	Pg13.5	D4NS-5AF
			G1/2	D4NS-6AF
			M20, includes M20-to-1/2-14NPT conversion adapter	D4NS-7AF
			M20	D4NS-8AF
		2NC	Pg13.5	D4NS-5BF (note 3)
			G1/2	D4NS-6BF
			M20, includes M20-to-1/2-14NPT conversion adapter	D4NS-7BF
			M20	D4NS-8BF (note 3)
		2NC/1NO	Pg13.5	D4NS-5CF
			G1/2	D4NS-6CF
			M20, includes M20-to-1/2-14NPT conversion adapter	D4NS-7CF
			M20	D4NS-8CF (note 3)
	3NC	Pg13.5	D4NS-5DF	
		G1/2	D4NS-6DF	
		M20, includes M20-to-1/2-14NPT conversion adapter	D4NS-7DF	
		M20	D4NS-8DF	
	Slow-action MBB contact	1NC/1NO	Pg13.5	D4NS-5EF
			G1/2	D4NS-6EF
			M20, includes M20-to-1/2-14NPT conversion adapter	D4NS-7EF
			M20	D4NS-8EF
		2NC/1NO	Pg13.5	D4NS-5FF
			G1/2	D4NS-6FF
			M20, includes M20-to-1/2-14NPT conversion adapter	D4NS-7FF
			M20	D4NS-8FF
1-conduit, with connector	Slow-action	1NC/1NO	M12 connector	D4NS-9AF (note 3)
		2NC	D4NS-9BF (note 3)	
	Slow-action MBB contact	1NC/1NO	D4NS-9EF (note 3)	

Note: 1. The recommended models for equipment and machinery being exported to Europe are those with an M20 or Pg13.5 conduit sizes, and for North America, the recommended models are those with a 1/2-14NPT conduit sizes.

2. Resin is used as the material for the D4NS housing and head. Use the metal D4BS Safety-door Switch for applications requiring greater mechanical strength.
3. Preferred stock item

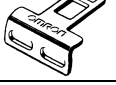
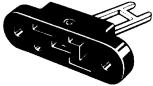
Operation Keys

Type	Model
Horizontal mounting 	D4DS-K1
Vertical mounting 	D4DS-K2
Adjustable mounting (Horizontal) 	D4DS-K3
Adjustable mounting (Horizontal/Vertical) 	D4DS-K5

Specifications

Approved Standards

Agency	Standard	File No.
TÜV Product Service	EN60947-5-1 (approved direct opening) GS-ET-15	B0306 39656052
UL (See note.)	UL508, CSA C22.2 No.14	E76675

Note: Approval for CSA C22.2 No. 14 is authorized by the UL mark.

Standards and EC Directives

- Conforms to the following EC Directives:
Machinery Directive
Low Voltage Directive
EN50047
EN1088

CCC (China Compulsory Certification) Mark

Agency	Standard	File No.
CQC	GB14048.5	Under application

Approved Standard Ratings

TÜV (EN60947-5-1)

Item	Utilization category	AC-15	DC-13
Rated operating current (I_o)		3 A	0.27 A
Rated operating voltage (U_o)		240 V	250 V

Note: Use a 10-A fuse type gI or gG that conforms to IEC269 as a short-circuit protection device. This fuse is not built into the Switch.

UL/CSA (UL508, CSA C22.2 No. 14)

A300

Rated voltage	Carry current	Current		Volt-amperes	
		Make	Break	Make	Break
120 VAC	10 A	60 A	6 A	7,200 VA	720 VA
240 VAC		30 A	3 A		

D4NS

Characteristics

Degree of protection (See note 3.)		IP67 (EN60947-5-1) (This applies for the Switch only. The degree of protection for the key hole is IP00.)	
Durability (See note 4.)	Mechanical	1,000,000 operations min.	
	Electrical	500,000 operations min. for a resistive load of 3 A at 250 VAC (See note 5.) 300,000 operations min. for a resistive load of 10 A at 250 VAC	
Operating speed		0.05 to 0.5 m/s	
Operating frequency		30 operations/minute max.	
Direct opening force (See note 6.)		60 N min.	
Direct opening travel (See note 6.)		10 mm min.	
Contact resistance		25 mΩ max.	
Minimum applicable load (See note 7.)		Resistive load of 1 mA at 5 VDC (N-level reference value)	
Rated insulation voltage (U_i)		300 V	
Protection against electric shock		Class II (double insulation)	
Pollution degree (operating environment)		3 (EN60947-5-1)	
Impulse withstand voltage (EN60947-5-1)		Between terminals of the same polarity	2.5 kV
		Between terminals of different polarities	4 kV
		Between other terminals and uncharged metallic parts	6 kV
Insulation resistance		100 MΩ min.	
Contact gap		2 x 2 mm min	
Vibration resistance	Malfunction	10 to 55 Hz, 0.75-mm single amplitude	
Shock resistance	Destruction	1,000 m/s ² min.	
	Malfunction	300 m/s ² min.	
Conditional short-circuit current		100 A (EN60947-5-1)	
Rated open thermal current (I_{th})		10 A (EN60947-5-1)	
Ambient temperature		Operating: -30°C to 70°C with no icing	
Ambient humidity		Operating: 95% max.	
Weight		Approx. 96 g (D4NS-1CF)	

Note: 1. The above values are initial values.

2. Once a contact has been used to switch a standard load, it cannot be used for a load of a smaller capacity. Doing so may result in roughening of the contact surface and contact reliability may be lost.
3. The degree of protection is tested using the method specified by the standard (EN60947-5-1). Confirm that sealing properties are sufficient for the operating conditions and environment beforehand. Although the switch box is protected from dust or water penetration, do not use the D4NS in places where foreign material may penetrate through the key hole on the head, otherwise Switch damage or malfunctioning may occur.
4. The durability is for an ambient temperature of 5°C to 35°C and an ambient humidity of 40% to 70%. For more details, consult your OMRON representative.
5. If the ambient temperature is greater than 35°C, do not pass the 3-A, 250-VAC load through more than 2 circuits.
6. These figures are minimum requirements for safe operation.
7. This value will vary with the switching frequency, environment, and reliability level. Confirm that correct operation is possible with the actual load beforehand.

Nomenclature

Structure

D4NS-□A□, D4NS-□B□, D4NS-□E□
 D4NS-□C□, D4NS-□D□, D4NS-□F□

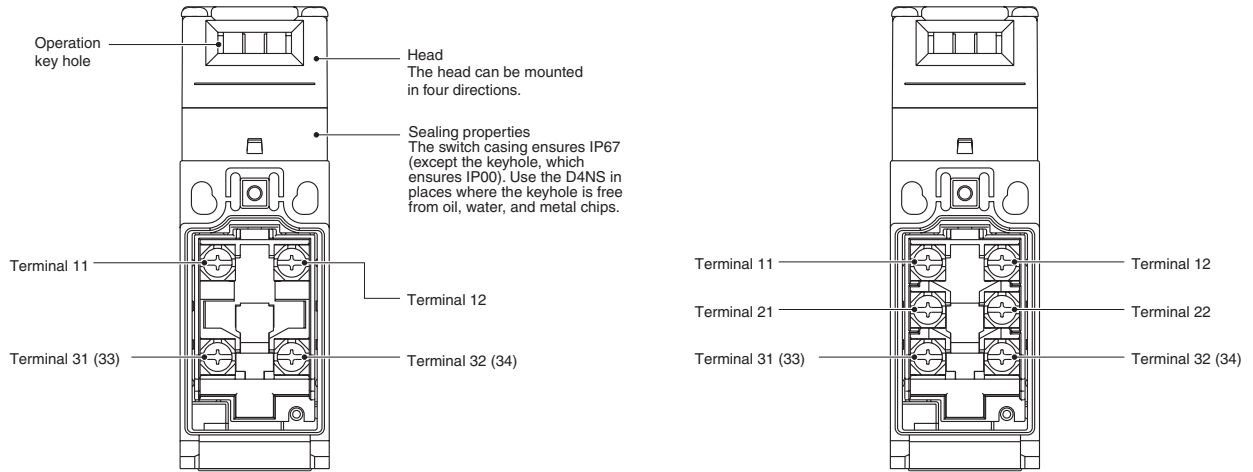

Note: The 2-conduit models have the same terminal arrangement.

Contact Form (Diagrams Show State with Key Inserted)

Model	Contact	Contact form	Operating pattern	Remarks
D4NS-□A□	1NC/1NO			Only NC contacts 11-12 have an approved direct opening mechanism. (→) The terminals 11-12 and 33-34 can be used as unlike poles.
D4NS-□B□	2NC			Only NC contacts 11-12 and 31-32 have an approved direct opening mechanism. (→) The terminals 11-12 and 31-32 can be used as unlike poles.
D4NS-□C□	2NC/1NO			Only NC contacts 11-12 and 21-22 have an approved direct opening mechanism. (→) The terminals 11-12, 21-22, and 33-34 can be used as unlike poles.
D4NS-□D□	3NC			Only NC contacts 11-12, 21-22, and 31-32 have an approved direct opening mechanism. (→) The terminals 11-12, 21-22, and 31-32 can be used as unlike poles.
D4NS-□E□	1NC/1NO MBB			Only NC contacts 11-12 have an approved direct opening mechanism. (→) The terminals 11-12 and 33-34 can be used as unlike poles.
D4NS-□F□	2NC/1NO MBB			Only NC contacts 11-12 and 21-22 have an approved direct opening mechanism. (→) The terminals 11-12, 21-22 and 33-34 can be used as unlike poles.

Note: MBB (Make Before Break) contacts have an overlapping structure, so that before the normally closed contact (NC) opens, the normally open contact (NO) closes.

D4NS

Operation Keys

Note: Unless otherwise specified, a tolerance of ± 0.4 mm applies to all dimensions.

D4DS-K1

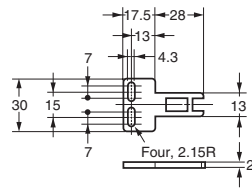
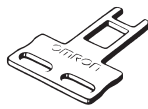

D4DS-K3

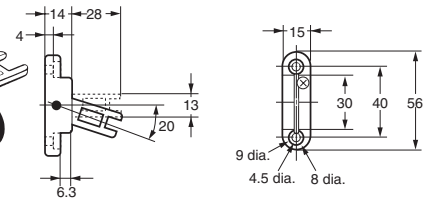
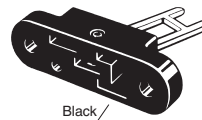

D4DS-K2

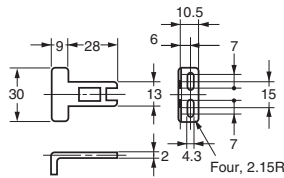
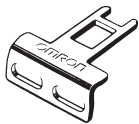

D4DS-K5

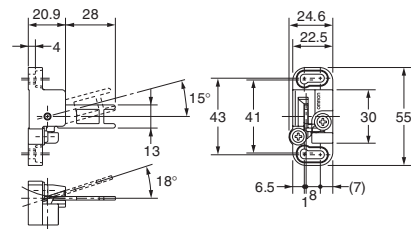
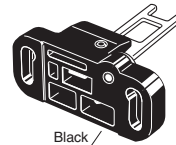

With Operation Key Inserted (Relationship between Insertion Radius and Insertion Hole)

Note: Unless otherwise specified, a tolerance of ± 0.4 mm applies to all dimensions.

D4NS-1□F + D4DS-K1

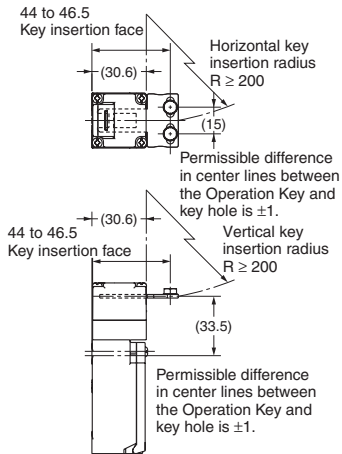
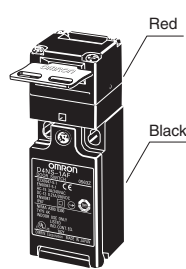

D4NS-1□F + D4DS-K2

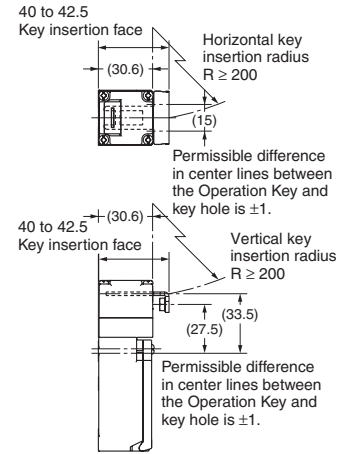
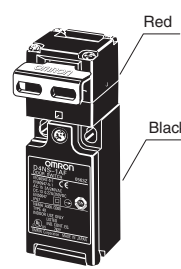

D4NS-1□F + D4DS-K3

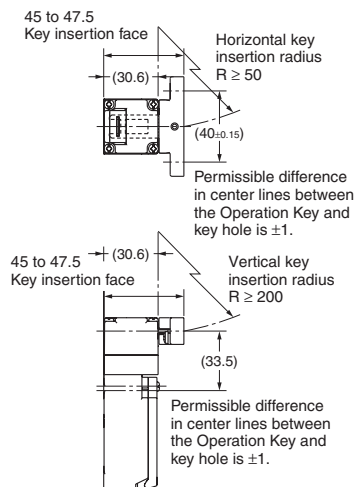
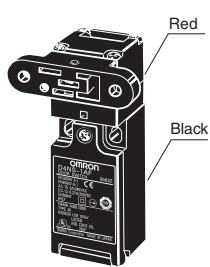

D4NS-1□F + D4DS-K5

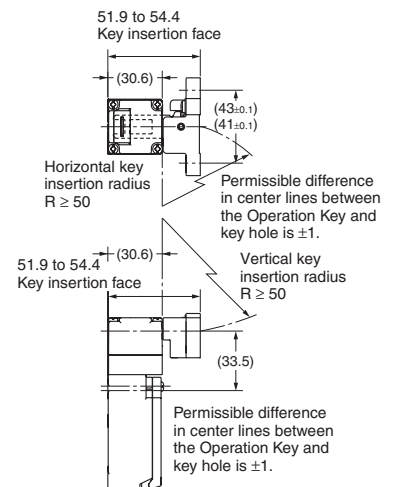
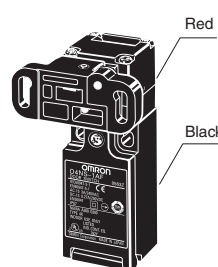

D4NS

Safety Precautions

Refer to *OMRON SAFETY COMPONENTS SERIES (Y106)* for common precautions.

CAUTION

Do not dismount the operation key from the door intentionally and insert it to the switch with the door open. Machine may start operating and injury or death may be caused.

Do not use metal connector or conduit with this switch. The broken conduit hole may cause electrical shock hazard.

Precautions for Safe Use

- Be careful not to drop your D4NS, or the switch will not fully exhibit its ability.
- Do not disassemble or remodel your D4NS in any case, or the D4NS will not operate normally.
- Do not use the switch where explosive gas, ignitable gas, or any other harmful gasses may be present.
- Install operation key so that it will not hit the operator when the door is open. Injury may be caused.
- Do not use the switch in the oil and in the water. IP67(EN60947-5-1)
- Though the switch body is protected from the ingress of dust or water, avoid the ingress of foreign substance through the key hole on the head.
- Otherwise, wear in short time or break may be caused
- Do not put the electric power when wiring.
- Be sure to install a cover after the wiring.
Do not put the electric power when opening a cover.
- Connect the fuse to the switch in series to prevent it from short circuit damage.
The value of the breaking current of the fuse must be increased to cover the rated current by 150 to 200%. When using the switch with EN rating, use 10 A fuse, type gI or gG that complies with IEC 60269.
- Keep the electrical load below the rated value.
- On the switching of general loads (250VAC/3A), do not operate two circuits or more at the same time. Otherwise, insulation performance may be degraded.
- The durability of the switch is seriously affected by operating conditions.
Evaluate the switch under actual working conditions before permanent installation.
- Please mention in machine manufacturer's Instruction. Manual that the user must not repair nor maintain the switch and must contact machine manufacturer for them.
- Do not use the switch as a stopper.
Be sure to install a stopper as shown in the following illustration to prevent the edge of the operation key from inadvertently hitting the switch directly.

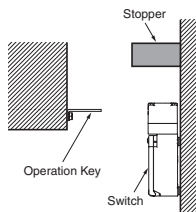

Precautions for Correct Use

1. Environment

- The switch is intended for indoor use only.
- Do not use your D4NS outdoor, or the switch will malfunction.
- Do not use your D4NS in the atmosphere of hazardous gases (H2S, SO2, NH3, HNO3, Cl2, etc.) or high temperature and humidity, or it will cause the imperfect closing of the contacts or the breakage thereof stemming from corrosion.
- Do not use the switch under any of the conditions mentioned below.
 - Frequent temperature range.
 - High humidity or dew condensation may be generated.
 - Where the switch is subject to severe vibration.
 - Where the metal dust, oil, or chemical is sprayed inside the door.
 - Where thinner is applied.

2. Mounting method

- Mounting Screw Tightening Torque
Loose mounting may result in malfunction.
Fasten the screws to the specified torque.

Terminal screw	0.6 to 0.8 N·m
Cover clamping screw	0.5 to 0.7 N·m
Head clamping screw	0.5 to 0.6 N·m
Operation Key clamping screw (See item 4)	2.4 to 2.8 N·m
Body clamping screw (See item 4)	0.5 to 0.7 N·m
Conduit mounting connection (see item 10,11), M12 changing adaptor	1.8 to 2.2 N·m
	1.4 to 1.8 N·m (1/2-14NPT)
Cap screw	1.3 to 1.7 N·m

• Switch, operation key

- The switch and operation key will be fastened to specified torque in item 2 with M4 screws and washers.
- Secured more by the studs like below picture 4-0.05/-0.15 dia., 4.8 max. height at the lower two which are inserted from back side of switch.

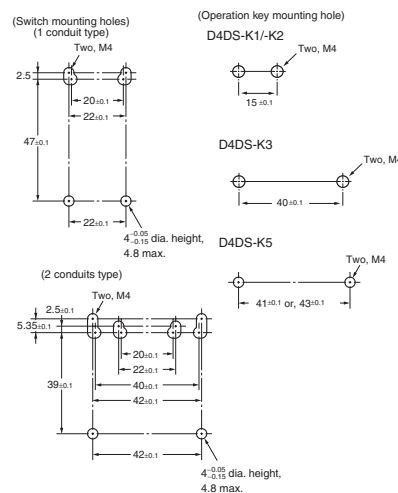

- Do not use the operation key other than dedicated OMRON's. Otherwise switch may be damaged.
- Be sure that the operation key can be inserted properly to key hole with a tolerance of ± 1 mm.

3. Head direction

The rotation of the switch head may be adjusted to any of the four directions by loosening the head clamping screws at the four corners of the head.

4. Securing of the door

If the operation key is pulled in the opening direction due to a force caused by vibration, by the door weight, or by a cushion attached to the door.

The closed door must be secured with a hook or by similar means.

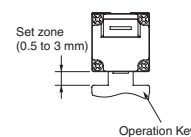

5. Wiring

- When connect with insulation tubes and terminals, connect the terminals as shown in the following figure and wire without overriding to the case and the cover. Adequate conductor size is AWG 20 to 18 (0.5 to 0.75 mm²).
Wire leads as shown in the following figure. Otherwise, the switch cover does not fit.

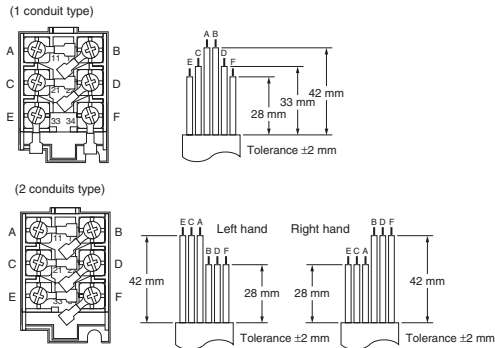

- Do not push the ring connector and the likes into the opening between the parts in order to prevent the case from being broken and deformed.
- Use terminals having the thickness of 0.5 mm or less to avoid the contact between the terminal and the switch case inside. The below listed the terminals have thickness of 0.5 mm or less.

Manufacture	Type	Wire size
J.S.T.	FV0.5-3.7 (F type) V0.5-3.7 (straight type)	AWG22 to 20

J.S.T is a Japanese manufacturer.

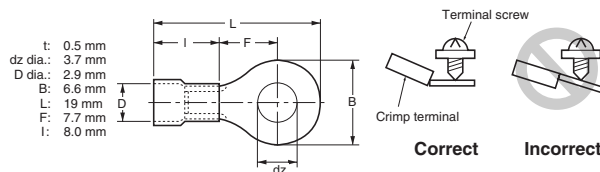

6. Contact arrangement

- The following show a safety contact and an auxiliary contact for 3 contacts and 2 contacts types.

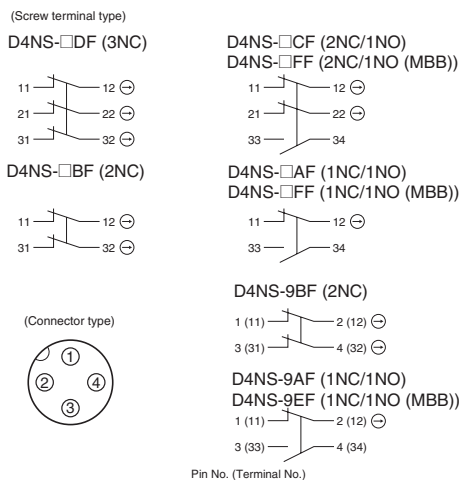

Suitable socket is Type XS2F (OMRON).

7. Socket tightening (connector type)

Do not use any tools, such as pliers, otherwise the socket connector may become damaged. Connect the socket connector to the connector threads of the D4NS. Then firmly turn the socket connector by hand so that the connector threaded portion will be completely covered by the socket connector so that space will be almost 0.

Make sure, however, that the socket connector is tightened securely, otherwise the rated degree of protection of the D4NS may not be maintained. Furthermore, the socket connector may be loosened by vibration.

8. Conduit opening

Use the connectors recommended in clause 9 and tighten the connector with specified torque in clause 2. An excessive torque will bring a case breakage.

Apply sealing tape between connector and conduit opening so that the enclosure will conform to IP67.

Use a cable with a suitable diameter for the connector.

For unused conduit opening, apply a conduit cap provided and tighten it to specified torque in clause 2.

9. Recommendation of connector

Use the connector with thread section of 9 mm long or less. In the case of the connector with longer thread section, protruded part may interfere with the other parts inside the body. Use below listed connector to secure IP67.

Size	Manufacture	Type	Adequate cable Diameter
G1/2	LAPP	ST-PF1/2 5380-1002	6.0 to 12.0 mm
	Ohm Denki	OA-W1609	7.0 to 9.0 mm
		OA-W1611	9.0 to 11.0 mm
Pg13.5	LAPP	S-13.5 5301-5030	6.0 to 12.0 mm
M20	LAPP	ST-M20 × 1.5 5311-1020	7.0 to 13.0 mm
1/2-14NPT	LAPP	ST-NPT1/2 5301-6030	6.0 to 12.0 mm
	HEYCO		4.3 to 11.9 mm
M12	LAPP	ST-M12 × 1.5 5301-1000	3.5 to 7.0 mm

When use LAPP's products, use together with a seal packing which is sold separately (Type names, JPK-16, GP-13.5, GPM20, GPM12 is for M12 connector) and tighten with proper tightening torque.

LAPP is a German manufacturer.

Ohm Denki is a Japanese manufacturer.

HEYCO is an American manufacturer.

Before using the 2 conduit type 1/2-14NPT connector, attach the appended changing adaptor to the switch, and wind the seal tape about the joint of the adaptor and switch.

When use M12 conduit type, connect the above listed connector, after tightened the M12 changing adaptor to the switch.

The M12 changing adaptor is enclosed with the packing.

10. Storage

Do not keep the switch in dusty, humid place and any place where gas may be present for example H₂S, SO₂, NH₃, HNO₃, Cl₂.

11. Others

- Do not impose excessive force on the key top while the operation key is inserted into the switch body or drop the switch with the operation key inserted to avoid the deformation of the key or the breakage of the switch body.
- Confirm that the seal rubber has no abnormality and then use it. If the seal rubber is displaced or floated, or if foreign matters adhere to the seal rubber, the seal rubber will lose its sealing capability.
- Do not use any screw other than correct one, or the sealing capability of the seal rubber will deteriorate.
- Please do a regular check in premeditation for this switch.

Production Termination

Following the release of the D4NS, production of the D4DS will be terminated.

Date of Production Termination

Production of the D4DS Series will be terminated in July 2006.

Date of Substitute Product Release

Sale of the D4NS Series commenced in July 2003.

Product Replacement

1. Dimensions

The D4DS and D4NS have basically the same structure, and use the same mounting method, Operation Keys, mounting hole and Operation Key insertion positions. The multi-contact structure and the extra 4 mm in length, however, are different.

2. Terminal Numbers

For the 2-contact model, the terminals 21, 22, 23, and 24 on the D4DS are 31, 32, 33, and 34 on the D4NS.

3. Recommended Terminals

If the recommended terminals are not used, the Switch may not be compatible. Make sure that the Switch is compatible with the terminals.

Comparison of the D4DS and Substitute Products

Model	D4NS-□
Switch color	Very similar
Dimensions	Very similar
Wiring/connection	Significantly different
Mounting method	Very similar
Ratings/performance	Very similar
Operating characteristics	Very similar
Operating method	Completely compatible

Dimensions (Unit: mm)

List of Recommended Substitute Products Switch

D4DS product	Recommended substitute product
D4DS-15FS	D4NS-1AF
D4DS-25FS	D4NS-2AF
D4DS-35FS	D4NS-3AF
D4DS-55FS	D4NS-5AF
D4DS-65FS	D4NS-6AF
D4DS-1AFS	D4NS-1BF
D4DS-2AFS	D4NS-2BF
D4DS-3AFS	D4NS-3BF
D4DS-5AFS	D4NS-5BF
D4DS-6AFS	D4NS-6BF

Operation Key

- D4DS-K1
- D4DS-K2
- D4DS-K3
- D4DS-K5

All of the above Operation Keys can be used with the D4NS.

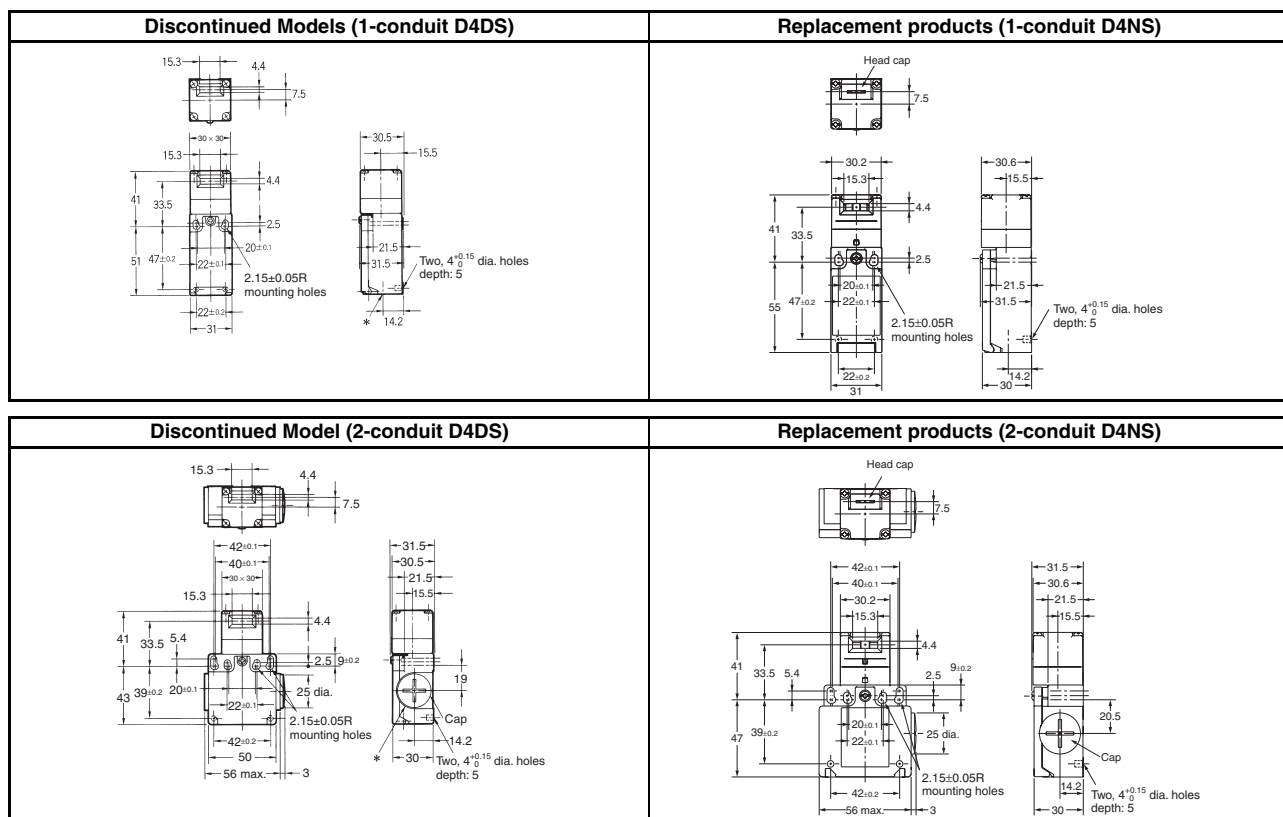

⚠ WARNING

This catalog is a guide to help customers select the proper safety product. Observe the following items when choosing products, select the right product for your device or equipment, and develop a safety-related system to fully utilize the product's functions.

Setting up a risk assessment system

The items listed in this catalog must be used properly in terms of product location as well as product performance and functionality. Part of the process of selecting and using these products should include the introduction and development of a risk assessment system early in the design development stage to help identify potential dangers in your equipment that will optimize safety product selection. A badly designed risk assessment system often results in poor choices when it comes to safety products.

- Related international standard: ISO 14121 "Principles of risk assessment."

Safety policy

When developing a safety system for the devices and equipment that use safety products, make every effort to understand and conform to the entire series of international and industrial standards available, such as the examples given below.

- Related international standards: ISO/DIS 12100 "Basic concepts, general principles for design"
IEC 61508 "Functional safety of electrical/electronic/programmable electronic safety-related systems."

Role of safety products

Safety products have functions and mechanisms that ensure safety as defined by standards. These functions and mechanisms are designed to attain their full potential within safety-related systems. Make sure you fully understand all functions and mechanisms, and use that understanding to develop systems that will ensure optimal usage.

- Related international standard: ISO 14119 "Interlocking devices associated with guards- Principles for design and selection."

Installing safety products

Make sure that properly educated and trained engineers are selected to develop your safety-related system and to install safety products in devices and equipment.

- Related international standards: ISO/DIS 12100 "Basic Concepts, general principles for design."
IEC 61508 "Functional safety of electrical/electronic/programmable electronic safety-related systems."

Observing laws and regulations

Safety products should conform to pertinent laws, regulations and standards, but make sure that they are used in accordance with the laws, regulations and standards of the country where the devices and equipment incorporating these products are distributed.

- Related international standard: IEC 60204 "Electrical equipment of machines."

Observing usage precautions

Carefully read the specifications and precautions listed in this catalog for your product as well as all items in the Operating Manual packed with the product to learn usage procedures that will optimize your choice. Any deviation from precautions will lead to unexpected device or equipment failure not anticipated by safety-related systems or fire originating from equipment failure.

Transferring devices and equipment

When transferring devices and equipment, be sure to keep one copy of the Operating Manual and pack another copy with the device or equipment so the person receiving it will have no problem operating it.

- Related international standards: ISO/DIS 12100 "Basic concepts, general principles for design"
IEC 61508 "Functional safety of electrical/electronic/programmable electronic safety-related systems."

ALL DIMENSIONS SHOWN ARE IN MILLIMETERS.

To convert millimeters into inches, multiply by 0.03937. To convert grams into ounces, multiply by 0.03527.