



Differential Coil Sensor for Long-distance Detecting (100 mm) for both Ferrous and Non-ferrous Substances

- Models also available for use under water.



 Be sure to read *Safety Precautions* on page 4.

Ordering Information

Appearance	Sensing distance	Output configuration	Model
Cylindrical (flat surface installation)	 100 mm	Current output	TL-L100-7 1M

Note: The TL-L100-10 is also available for use under water (JIS0920: Withstand pressure of 0.39 MPa).

Ratings and Specifications

Item	Output specifications	Current output
	TL-L100-7	
Sensing distance	100 mm ±10%	
Set distance	0 to 80 mm	
Differential travel	15% max. of sensing distance	
Detectable object	Ferrous metal and non-ferrous metal	
Standard sensing object	Iron, 200 × 200 × 1 mm	
Response time	100 ms max.	
Power supply voltage (operating voltage range)	10 to 30 VDC including 10% ripple (p-p)	
Current consumption	40 mA DC max.	
Control output	200 mA DC max. (residual voltage: 1 V max.)	
Indicators	Operation indicator (red)	
Operation mode (with sensing object approaching)	NO; For details, refer to the timing charts under <i>I/O Circuit Diagrams</i> on page 3.	
Protection circuits	Reverse polarity protection, Surge suppressor	
Ambient temperature range	Operating/Storage: -25 to 55°C (with no icing or condensation)	
Ambient humidity range	Operating/Storage: 35% to 95% (with no condensation)	
Temperature influence	±30% max. of sensing distance at 20°C in the temperature range of -10 to 40°C	
Voltage influence	±5% max. of sensing distance at rated voltage in rated voltage ±10% range	
Insulation resistance	5 MΩ min. (at 500 VDC) between current-carrying parts and case	
Dielectric strength	500 VAC, 50/60 Hz for 1 min between current-carrying parts and case	
Vibration resistance	Destruction: 10 to 55 Hz, 1.5-mm double amplitude for 2 hours each in X, Y, and Z directions	
Shock resistance	Destruction: 200 m/s ² 10 times each in X, Y, and Z directions	
Degree of protection	IP66 (IEC)	
Connection method	Pre-wired Models (Standard cable length: 1m)	
Weight (packed state)	Approx. 1.5 kg	
Materials	Case: Aluminum die-cast, Sensing surface: Epoxy resin	
Accessories	Instruction manual	

Engineering Data (Typical)

Sensing Area

TL-L100-7

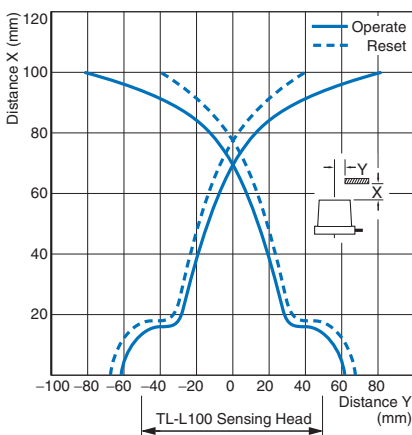





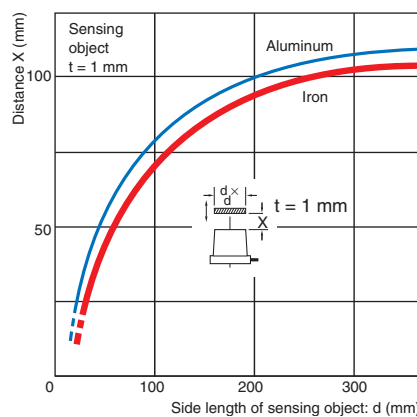



Influence of Sensing Object Size and Material

TL-L100-7

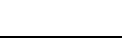

I/O Circuit Diagrams

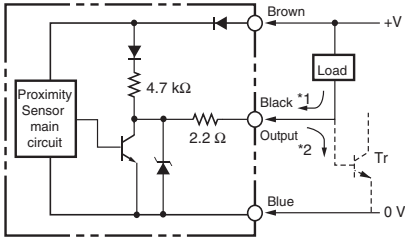
Output configuration	Model	Timing chart	Output circuit
Current output NO	TL-L100-7	<p>Sensing object</p> <p>Present </p> <p>None </p> <p>Load (between brown and black leads)</p> <p>Operate </p> <p>Reset </p> <p>Output voltage (between black and blue leads)</p> <p>High </p> <p>Low </p> <p>Operation indicator (red)</p> <p>ON </p> <p>OFF </p>	 <p>*1. Load current: 200 mA max. *2. When a transistor is connected.</p>

Connections

Connection to the S3D2 Sensor Controller

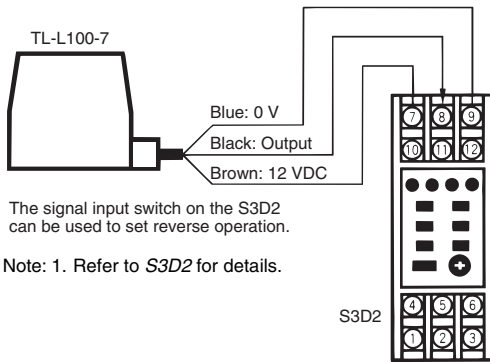

Safety Precautions

Refer to *Warranty and Limitations of Liability*.

⚠ WARNING

This product is not designed or rated for ensuring safety of persons either directly or indirectly. Do not use it for such purposes.



Precautions for Correct Use

Do not use this product under ambient conditions that exceed the ratings.

● **Design**

Influence of Surrounding Metal

Separate the Sensor from surrounding metal as shown below.

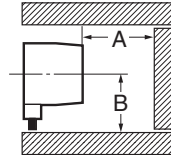

Influence of Surrounding Metal

Item	Dimension (mm)
A	250
B	

Mutual Interference

When mounting more than one Sensor face-to-face or side-by-side, separate them as shown below.

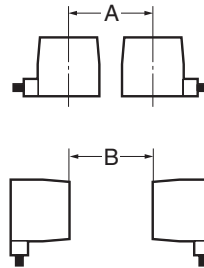

Mutual Interference

Item	Dimension (mm)
A	300
B	

Dimensions

(Unit: mm)

Tolerance class IT16 applies to dimensions in this data sheet unless otherwise specified.

TL-L100-7

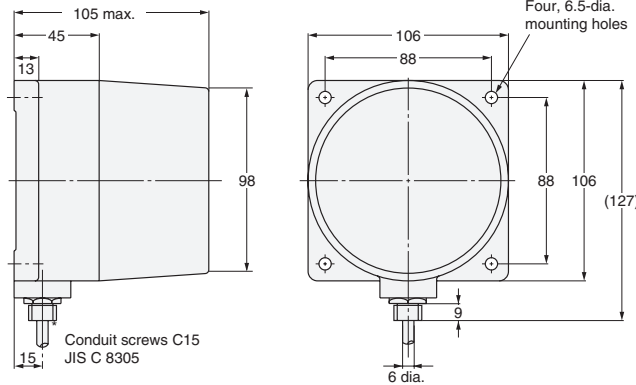
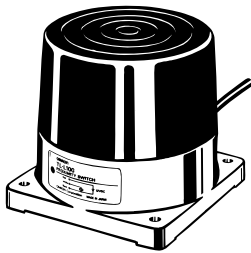

* 6-dia. vinyl-insulated round cable with 3 conductors (Conductor cross section: 0.3 mm², Insulator diameter: 1.85 mm), Standard length: 1 m

Mounting Hole Dimensions

Four, M6 or 6.5-dia. holes

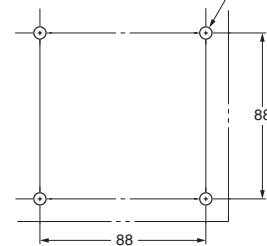

Read and Understand This Catalog

Please read and understand this catalog before purchasing the products. Please consult your OMRON representative if you have any questions or comments.

Warranty and Limitations of Liability

WARRANTY

OMRON's exclusive warranty is that the products are free from defects in materials and workmanship for a period of one year (or other period if specified) from date of sale by OMRON.

OMRON MAKES NO WARRANTY OR REPRESENTATION, EXPRESS OR IMPLIED, REGARDING NON-INFRINGEMENT, MERCHANTABILITY, OR FITNESS FOR PARTICULAR PURPOSE OF THE PRODUCTS. ANY BUYER OR USER ACKNOWLEDGES THAT THE BUYER OR USER ALONE HAS DETERMINED THAT THE PRODUCTS WILL SUITABLY MEET THE REQUIREMENTS OF THEIR INTENDED USE. OMRON DISCLAIMS ALL OTHER WARRANTIES, EXPRESS OR IMPLIED.

LIMITATIONS OF LIABILITY

OMRON SHALL NOT BE RESPONSIBLE FOR SPECIAL, INDIRECT, OR CONSEQUENTIAL DAMAGES, LOSS OF PROFITS OR COMMERCIAL LOSS IN ANY WAY CONNECTED WITH THE PRODUCTS, WHETHER SUCH CLAIM IS BASED ON CONTRACT, WARRANTY, NEGLIGENCE, OR STRICT LIABILITY.

In no event shall the responsibility of OMRON for any act exceed the individual price of the product on which liability is asserted.

IN NO EVENT SHALL OMRON BE RESPONSIBLE FOR WARRANTY, REPAIR, OR OTHER CLAIMS REGARDING THE PRODUCTS UNLESS OMRON'S ANALYSIS CONFIRMS THAT THE PRODUCTS WERE PROPERLY HANDLED, STORED, INSTALLED, AND MAINTAINED AND NOT SUBJECT TO CONTAMINATION, ABUSE, MISUSE, OR INAPPROPRIATE MODIFICATION OR REPAIR.

Application Considerations

SUITABILITY FOR USE

OMRON shall not be responsible for conformity with any standards, codes, or regulations that apply to the combination of products in the customer's application or use of the products.

At the customer's request, OMRON will provide applicable third party certification documents identifying ratings and limitations of use that apply to the products. This information by itself is not sufficient for a complete determination of the suitability of the products in combination with the end product, machine, system, or other application or use.

The following are some examples of applications for which particular attention must be given. This is not intended to be an exhaustive list of all possible uses of the products, nor is it intended to imply that the uses listed may be suitable for the products:

- Outdoor use, uses involving potential chemical contamination or electrical interference, or conditions or uses not described in this catalog.
- Nuclear energy control systems, combustion systems, railroad systems, aviation systems, medical equipment, amusement machines, vehicles, safety equipment, and installations subject to separate industry or government regulations.
- Systems, machines, and equipment that could present a risk to life or property.

Please know and observe all prohibitions of use applicable to the products.

NEVER USE THE PRODUCTS FOR AN APPLICATION INVOLVING SERIOUS RISK TO LIFE OR PROPERTY WITHOUT ENSURING THAT THE SYSTEM AS A WHOLE HAS BEEN DESIGNED TO ADDRESS THE RISKS, AND THAT THE OMRON PRODUCTS ARE PROPERLY RATED AND INSTALLED FOR THE INTENDED USE WITHIN THE OVERALL EQUIPMENT OR SYSTEM.

PROGRAMMABLE PRODUCTS

OMRON shall not be responsible for the user's programming of a programmable product, or any consequence thereof.

Disclaimers

CHANGE IN SPECIFICATIONS

Product specifications and accessories may be changed at any time based on improvements and other reasons.

It is our practice to change model numbers when published ratings or features are changed, or when significant construction changes are made. However, some specifications of the products may be changed without any notice. When in doubt, special model numbers may be assigned to fix or establish key specifications for your application on your request. Please consult with your OMRON representative at any time to confirm actual specifications of purchased products.

DIMENSIONS AND WEIGHTS

Dimensions and weights are nominal and are not to be used for manufacturing purposes, even when tolerances are shown.

PERFORMANCE DATA

Performance data given in this catalog is provided as a guide for the user in determining suitability and does not constitute a warranty. It may represent the result of OMRON's test conditions, and the users must correlate it to actual application requirements. Actual performance is subject to the OMRON Warranty and Limitations of Liability.

ERRORS AND OMISSIONS

The information in this document has been carefully checked and is believed to be accurate; however, no responsibility is assumed for clerical, typographical, or proofreading errors, or omissions.

2008.11

In the interest of product improvement, specifications are subject to change without notice.

OMRON Corporation
Industrial Automation Company

<http://www.ia.omron.com/>

(c)Copyright OMRON Corporation 2008 All Right Reserved.