

HOA0902

Transmissive Encoder Sensor

FEATURES

- Dual channel IC
- Direct TTL interface
- Resolution to 0.018 in. (.457)
- Internal temperature compensation
- 0.126 in. (3.2 mm) slot width
- Two mounting configurations

DESCRIPTION

The HOA0902 assembly consists of a dual channel IC detector and an IRED encased in a black thermoplastic housing. The device is typically used with an interrupter strip or disk (code wheel) to encode the rate and direction of mechanical motion. Applications include linear and rotary encoders; it is especially suited for the encoding function in an optical mouse.

The detector is a monolithic IC which consists of two narrow adjacent photodiodes, amplifiers stages and quadrature logic circuitry which provides two outputs; (1) a fixed-duration, low level active tachometer (counting) pulse which is generated whenever the illumination level passes through the sensing threshold, and (2) a direction output which is set to a logic high or low level dependent on which of the two channels is illuminated first. The tachometer output is an NPN collector which is internally connected to V_{CC} through a 10 k Ω (nominal) resistor; the direction output is a totem-pole configuration. Both outputs are capable of directly driving TTL loads. The IC design incorporates circuitry to compensate the sensitivity for the output power vs. temperature characteristic of the IRED.

The tachometer pulse is generated at both the increasing and decreasing illumination thresholds of the sensing channel, resulting in two tach pulses for each mechanical period of the interrupter. The HOA0902 is designed to work with a mechanical period as small as 0.036 in. (.914 mm), providing resolution to 0.018 in. (.457 mm). For additional component information see SEP8506 and HLC2705.

Housing material is polycarbonate. Housings are soluble in chlorinated hydrocarbons and ketones. Recommended cleaning agents are methanol and isopropanol.

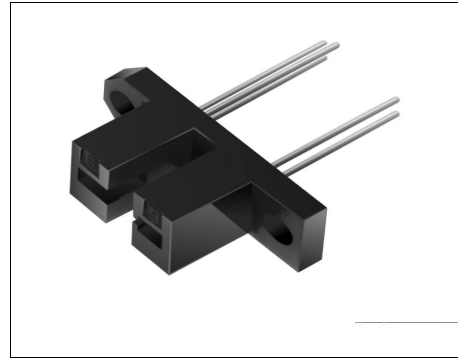

INFRA-78.TIF

OUTLINE DIMENSIONS in inches (mm)

Tolerance 3 plc decimals $\pm 0.005(0.12)$
 2 plc decimals $\pm 0.020(0.51)$

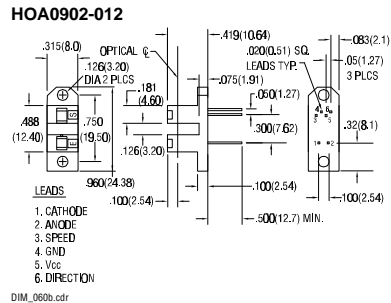
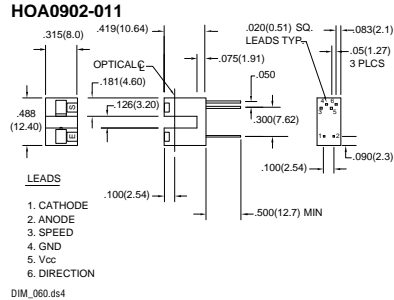

HOA0902

Transmissive Encoder Sensor

ELECTRICAL CHARACTERISTICS (25°C unless otherwise noted)

PARAMETER	SYMBOL	MIN	TYP	MAX	UNITS	TEST CONDITIONS
IR EMITTER						
Forward Voltage	V_F		1.6		V	$I_F=20\text{ mA}$
Reverse Leakage Current	I_R		10		μA	$V_R=3\text{ V}$
DETECTOR						
Operating Supply Voltage	V_{CC}	4.5		5.5	V	
Supply Current	I_{CC}		12		mA	$V_{CC}=5.25\text{ V}$
Tach Output, inactive	$V_{OL,TACH}$	4.5			V	$V_{CC}=5\text{ V}, I_{OH}=0$
Tach Pulse Level, active			0.4		V	$V_{CC}=5\text{ V}, I_{OL}=1.6\text{ mA}$
Direction Output, B leads A	$V_{OH,DIR}$	2.4			V	$V_{CC}=5\text{ V}, I_{OH}=-10\text{ }\mu\text{A}$
Direction Output, A leads B	$V_{OL,DIR}$		0.4		V	$V_{CC}=5\text{ V}, I_{OL}=1.6\text{ mA}$
Tach Pulse Width	T_{PW}	3.0		20	μs	$V_{CC}=5\text{ V}, I_{OL}=1.6\text{ mA}$
IRET Trigger Current	I_{FT}			15	mA	$V_{CC}=5\text{ V}$
HOA0902-011, -012						

Notes

1. It is recommended that a bypass capacitor, 0.1 μF typical, be added between V_{CC} and GND near the device in order to stabilize power supply line.

ABSOLUTE MAXIMUM RATINGS

(25°C Free-Air Temperature unless otherwise noted)

Operating Temperature Range	-40°C to 70°C
Storage Temperature Range	-40°C to 85°C
Soldering Temperature (5 sec)	240°C

IR EMITTER

Power Dissipation	100 mW ⁽¹⁾
Reverse Voltage	3 V
Continuous Forward Current	50 mA

DETECTOR

Supply Voltage	5.5 V
Duration of Output	
Short to V_{CC} or Ground	1.0 sec.

Notes

1. Derate linearly 0.78 mW/°C above 25°C.

Honeywell reserves the right to make changes in order to improve design and supply the best products possible.

Honeywell

221

HOA0902

Transmissive Encoder Sensor

FUNCTIONAL BLOCK DIAGRAM

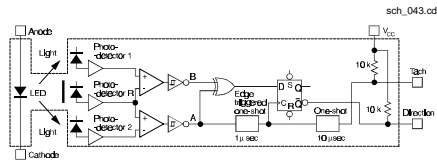

OUTPUT CONFIGURATION WITH MOTION

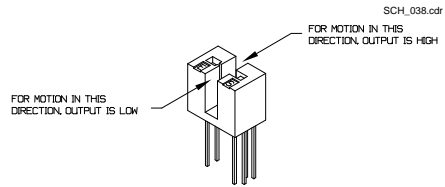

OUTPUT TIMING DIAGRAM

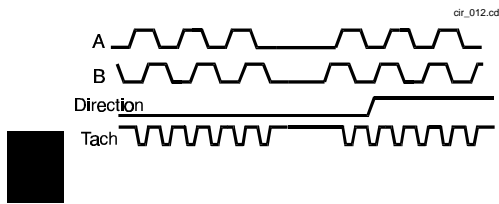

Fig. 1 IRED Forward Bias Characteristics

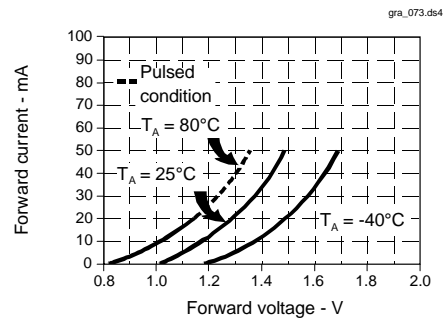
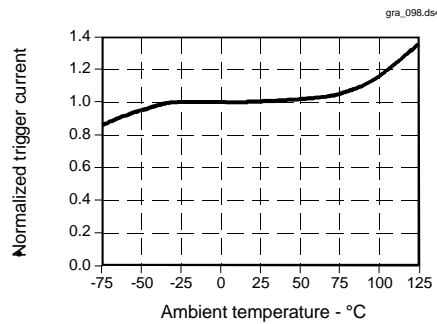

Fig. 2 IRED Trigger Current vs Temperature



All Performance Curves Show Typical Values

HOA0902

Transmissive Encoder Sensor

Honeywell reserves the right to make changes in order to improve design and supply the best products possible.

Honeywell

223