

# SDP8105

## Silicon Photodarlington

### FEATURES

- T-1 plastic package
- 20° (nominal) acceptance angle
- Consistent optical properties
- Mechanically and spectrally matched to SEP8505 and SEP8705 infrared emitting diodes

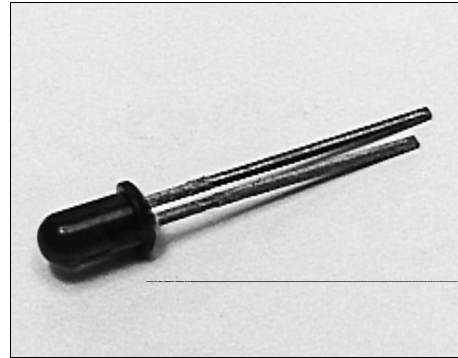

INFRA-55.TIF

### DESCRIPTION

The SDP8105 is an NPN silicon photodarlington transfer molded in a T-1 black plastic package to minimize effect of visible ambient light. Transfer molding of this device assures superior optical centerline performance compared to other molding processes. Lead lengths are staggered to provide a simple method of polarity identification.

### OUTLINE DIMENSIONS in inches (mm)

Tolerance 3 plc decimals ±0.005(0.12)  
2 plc decimals ±0.020(0.51)

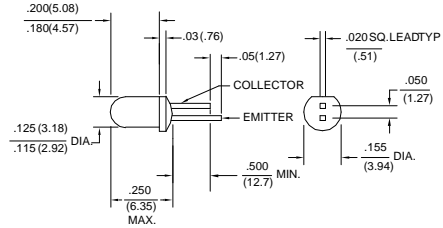

DIM\_100.d64

# SDP8105

## Silicon Photodarlington

### ELECTRICAL CHARACTERISTICS (25°C unless otherwise noted)

| PARAMETER                            | SYMBOL        | MIN | TYP | MAX | UNITS         | TEST CONDITIONS  |
|--------------------------------------|---------------|-----|-----|-----|---------------|--|
| Light Current<br>SDP8105-001         | $I_L$         | 0.5 |     |     | mA            | $V_{CE}=5\text{ V}$<br>$H=0.025\text{ mW/cm}^2$ (1)                |
| Collector Dark Current               | $I_{CEO}$     |     |     | 250 | nA            | $V_{CE}=10\text{ V}$ , $H=0$                                       |
| Collector-Emitter Breakdown Voltage  | $V_{(BR)CEO}$ | 15  |     |     | V             | $I_C=100\text{ }\mu\text{A}$                                       |
| Emitter-Collector Breakdown Voltage  | $V_{(BR)ECO}$ | 5.0 |     |     | V             | $I_E=100\text{ }\mu\text{A}$                                       |
| Collector-Emitter Saturation Voltage | $V_{CE(SAT)}$ |     | 1.1 |     | V             | $I_C=I_L/8$<br>$H=0.025\text{ mW/cm}^2$                            |
| Angular Response (2)                 | $\emptyset$   |     | 20  |     | degr.         | $I_F=\text{Constant}$  |
| Rise And Fall Time                   | $t_r, t_f$    |     | 75  |     | $\mu\text{s}$ | $V_{CC}=5\text{ V}$ , $I_L=1\text{ mA}$<br>$R_L=100\text{ }\Omega$ |

#### Notes

- The radiation source is an IRED with a peak wavelength of 935 nm.
- Angular response is defined as the total included angle between the half sensitivity points.

### ABSOLUTE MAXIMUM RATINGS

(25°C Free-Air Temperature unless otherwise noted)

|                               |               |
|-------------------------------|---------------|
| Collector-Emitter Voltage     | 15 V          |
| Emitter-Collector Voltage     | 5 V           |
| Power Dissipation             | 70 mW (1)     |
| Operating Temperature Range   | -40°C to 85°C |
| Storage Temperature Range     | -40°C to 85°C |
| Soldering Temperature (5 sec) | 240°C         |

#### Notes

- Derate linearly from 25°C free-air temperature at the rate of 0.18 mW/°C.

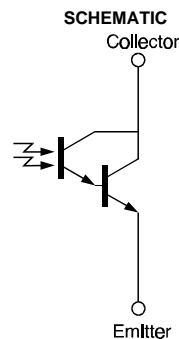

Honeywell reserves the right to make changes in order to improve design and supply the best products possible.

# Honeywell

165

# SDP8105

## Silicon Photodarlington

SWITCHING TIME TEST CIRCUIT

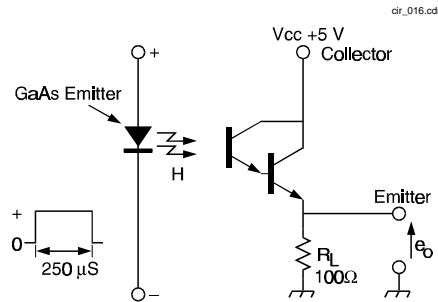

SWITCHING WAVEFORM

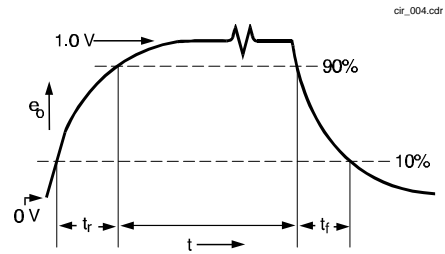

Fig. 1 Responsivity vs Angular Displacement

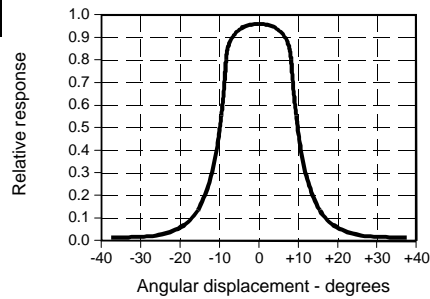

Fig. 2 Non-Saturated Switching Time vs Load Resistance

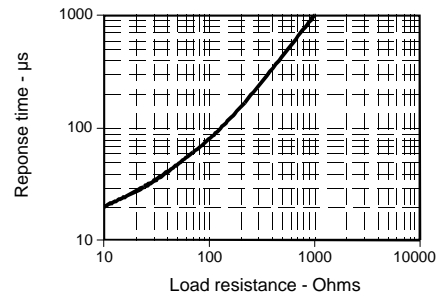
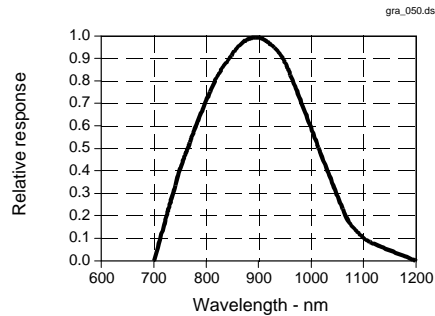

Fig. 3 Spectral Responsivity



All Performance Curves Show Typical Values

# SDP8105

Silicon Photodarlington

---



Honeywell reserves the right to make changes in order to improve design and supply the best products possible.

**Honeywell**