

SD2420

Silicon Photodiode

FEATURES

- Miniature, hermetically sealed, pill style, metal can package
- 48° (nominal) acceptance angle
- Wide operating temperature range (-55°C to +125°C)
- Ideal for direct mounting to printed circuit boards
- Mechanically and spectrally matched to SE2460 and SE2470 infrared emitting diodes

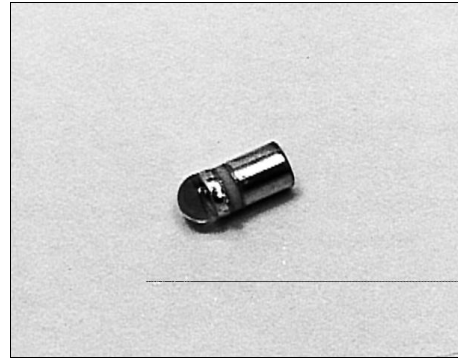

INFRA-1.TIF

DESCRIPTION

The SD2420 is a PN silicon photodiode mounted in a hermetically sealed, glass lensed, metal can package. This package directly mounts in double sided PC boards.

OUTLINE DIMENSIONS in inches (mm)

Tolerance 3 plc decimals ±0.005(0.12)
 2 plc decimals ±0.020(0.51)

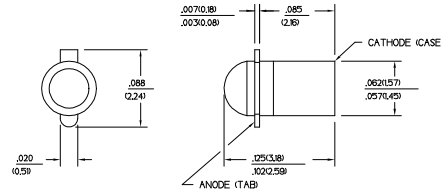

DIM_014.cdr

SD2420

Silicon Photodiode

ELECTRICAL CHARACTERISTICS (25°C unless otherwise noted)

PARAMETER	SYMBOL	MIN	TYP	MAX	UNITS	TEST CONDITIONS
Light Current SD2420-002	I_L	7.0			μA	$V_R=20\text{ V}$ $H=20\text{ mW/cm}^2$ (1)
Dark Current	I_D			5.0	nA	$V_R=20\text{ V}$ $H=0$
Reverse Breakdown Voltage	V_{BR}	50			V	$I_R=10\ \mu\text{A}$
Angular Response (2)	\emptyset		48		degr.	$I_F=\text{Constant}$
Rise And Fall Time	t_r, t_f		50		ns	$V_R=20\text{ V}$ $R_L=50\ \Omega$

Notes

- The radiation source is a tungsten lamp operating at a color temperature of 2870°K.
- Angular response is defined as the total included angle between the half sensitivity points.

ABSOLUTE MAXIMUM RATINGS

(25°C Free-Air Temperature unless otherwise noted)

Cathode Anode Voltage	50 V
Power Dissipation	125 mW (1)
Operating Temperature Range	-55°C to 125°C
Storage Temperature Range	-65°C to 150°C
Soldering Temperature (10 sec)	260°C

Notes

- Derate linearly from 25°C free-air temperature at the rate of 1.19 mW/°C.

SCHEMATIC

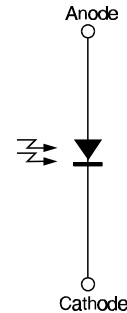

Honeywell reserves the right to make changes in order to improve design and supply the best products possible.

Honeywell

85

SD2420

Silicon Photodiode

SWITCHING TIME TEST CIRCUIT

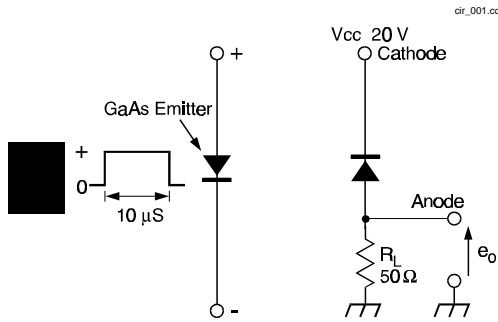

SWITCHING WAVEFORM

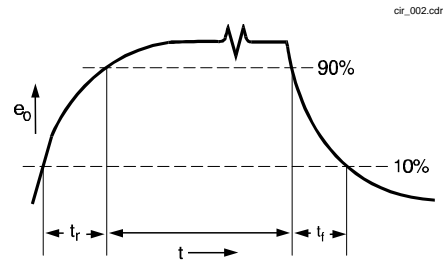

Fig. 1 Responsivity vs Angular Displacement

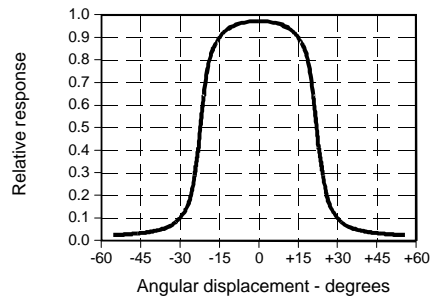

Fig. 2 Dark Current vs Temperature

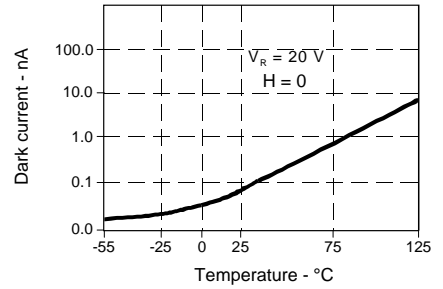
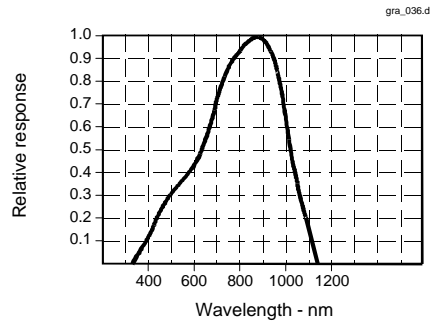

Fig. 3 Spectral Responsivity



All Performance Curves Show Typical Values

SD2420
Silicon Photodiode



Honeywell reserves the right to make changes in order to improve design and supply the best products possible.

Honeywell