

Accessories for Standard Sensors (photoelectric, inductive, capacitive)

Sensor Accessories



Cable connectors A-2



Extended wiring accessories A-19





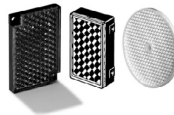







Mounting brackets A-28



Reflectors A-34

Cable Connectors

Product group		Cable Connectors				
						
Type		General purpose (screw)		General purpose (snap)	General purpose - extended wiring	small size (screw or snap)
Order reference		Y92E-M08	Y92E-M12	Y92E-MS08	XS2F-□-A	XS3F-□-A
Applicable/ Recommended Sensors		Inductive: E2A-□-M5, E2A-□-M3, E2E small diameter, E2EL, E2C-EDA photoelectric: E3Z, E3G-L1/L3, E3C, E3X All sensors with M8-junction connec- tors -M3J, -M5J	Photoelectric: E3F2, E3G-(M)R, E3G-(M)L7, E3S-C, E3MV, E3NT Inductive: E2□-□-M1, E2E, E2E□, E2F All sensors with M12 junction connec- tor -M1J	Inductive: E2A-□-M5, E2A-□-M3, E2E small diameter, E2EL, E2C-EDA Photoelectric: E3Z, E3G-L1/L3, E3C, E3X	See Y92E-M12 plus AC 2-wire types: E2E-□Y, E2F-□Y, E3F2-□Z	Inductive: E2A-□-M3, E2E small diameter, E2EL, E2C-EDA Photoelectric: E3Z, E3G-L1/L3, E3C, E3X All sensors with M8-junction connec- tors -M3J
Features		- 3 or 4 pin - LED optionally	- 3, 4 or 5 wire - LED optionally	3 or 4 pin	2, 3, 4 or 5 wire	4 pin
Size		M8	M12	M8	M12	M8
Material	Nut	Brass (CuZn) or zinc diecast (ZnAl Cu)		PUR	brass	
	Cable	PVC or PUR		PVC or PUR	PVC	

Product group		Cable Connectors					
							
Type		Robot cable (vibration resistant)		Detergent resistant		Fire retardant	Spatter proof
Order reference		XS3F-□-R	XS2F-□-R	Y92E-S08	Y92E-S12	XS2F-□-F	XS2F-□-AS
Applicable/ Recommended Sensors		See Y92E-M08	See Y92E-M12	E3ZM	E2FM	See Y92E-M12	E2FM
Features		4 pin	3, 4 or 5 wire	3 or 4 pin	4 wire	3, 4 or 5 wire	4 wire
Size		M8	M12	M8	M12	M12	M12
Material	Nut	brass		stainless steel		brass	brass
	Cable	PVC		PVC		PVC	Polyethylene

General Purpose Cable Connectors (M8 / M12)

Y92E

Model Number Legend

Y92E - □□□□ - □□□□ - □
 1 2 3 4 5 6 7 8 9

1. Connector type

- M: standard female screw on connector
- S: stainless steel female screw on connector
- MM: male metric screw plug
- MS: female snap connector

2. Size

- 08: M8 size
- 12: M12 size

3. Material

- PVC: PVC cable
- PUR: PUR cable

4. Nr of poles

- 3: 3 poles
- 4: 4 poles
- 5: 5 poles

5. Shape

- A: angled
- S: straight

6. Length

- 2M: standard 2 m length
- 5M: standard 5 m length
- 10M: standard 10 m length

7. LED

- LED: with LED
- [blank]: no LED

8. Specials

9. Supply code

- L designed and manufactured by Lumberg
- H designed and manufactured by Hirschmann

Ordering information

General purpose models

Product description ¹	Connector	Size	Cable material	Poles	Type	Length (m)	LED	Nut
Y92E-M08PUR3A2M-x	female	M8	PUR	3	Angled	2	no	-H: Zinc diecast (ZnAl Cu) -L: brass (CuZn)
Y92E-M08PUR3A5M-x						5		
Y92E-M08PUR3A10M-x						10		
Y92E-M08PUR3S2M-x					Straight	2		
Y92E-M08PUR3S5M-x						5		
Y92E-M08PUR3S10M-x						10		
Y92E-M08PUR4A2M-x				4	Angled	2		
Y92E-M08PUR4A5M-x						5		
Y92E-M08PUR4A10M-x						10		
Y92E-M08PUR4S2M-x					Straight	2		
Y92E-M08PUR4S5M-x						5		
Y92E-M08PUR4S10M-x						10		
Y92E-M08PVC3A2M-x			PVC		3	Angled	2	
Y92E-M08PVC3A5M-x							5	
Y92E-M08PVC3A10M-x							10	
Y92E-M08PVC3S2M-x						Straight	2	
Y92E-M08PVC3S5M-x							5	
Y92E-M08PVC3S10M-x							10	
Y92E-M08PVC4A2M-x					4	Angled	2	
Y92E-M08PVC4A5M-x							5	
Y92E-M08PVC4A10M-x							10	
Y92E-M08PVC4S2M-x						Straight	2	
Y92E-M08PVC4S5M-x							5	
Y92E-M08PVC4S10M-x							10	

Product description ¹	Connector	Size	Cable material	Poles	Type	Length (m)	LED	Nut			
Y92E-M12PUR3A2M-x	female	M12	PUR	3	Angled	2	no	-H: Zinc diecast (ZnAl Cu) -L: brass (CuZn)			
Y92E-M12PUR3A5M-x						5					
Y92E-M12PUR3A10M-x						10					
Y92E-M12PUR3S2M-x					Straight	2					
Y92E-M12PUR3S5M-x						5					
Y92E-M12PUR3S10M-x						10					
Y92E-M12PUR4A2M-x				4	Angled	2					
Y92E-M12PUR4A5M-x						5					
Y92E-M12PUR4A10M-x						10					
Y92E-M12PUR4S2M-x					Straight	2					
Y92E-M12PUR4S5M-x						5					
Y92E-M12PUR4S10M-x						10					
Y92E-M12PUR5A2M-x				5	Angled	2					
Y92E-M12PUR5A5M-x						5					
Y92E-M12PUR5S2M-x						Straight			2		
Y92E-M12PUR5S5M-x			5								
Y92E-M12PVC3A2M-x			PVC	3	Angled				2		
Y92E-M12PVC3A5M-x						5					
Y92E-M12PVC3A10M-x						10					
Y92E-M12PVC3S2M-x					Straight	2					
Y92E-M12PVC3S5M-x						5					
Y92E-M12PVC3S10M-x						10					
Y92E-M12PVC4A2M-x				4	Angled	2					
Y92E-M12PVC4A5M-x						5					
Y92E-M12PVC4A10M-x						10					
Y92E-M12PVC4S2M-x					Straight	2					
Y92E-M12PVC4S5M-x						5					
Y92E-M12PVC4S10M-x						10					
Y92E-M12PVC5A2M-x				5	Angled	2					
Y92E-M12PVC5A5M-x						5					
Y92E-M12PVC5A10M-x						10					
Y92E-M12PVC5S2M-x			Straight	2							
Y92E-M12PVC5S5M-x				5							
Y92E-M12PVC5S10M-x	10										
Y92E-M08PUR3A2MLED-x	M8	PUR	3	Angled	2	yes					
Y92E-M08PUR3A5MLED-x		5									
Y92E-M08PVC3A2MLED-x	PVC	3			Angled			2			
Y92E-M08PVC3A5MLED-x								5			
Y92E-M12PUR3A2MLED-x	M12							PUR	Angled	2	
Y92E-M12PUR3A5MLED-x					5						
Y92E-M12PUR3A10MLED-x				10							
Y92E-M12PVC3A2MLED-x				PVC	3				Angled	2	
Y92E-M12PVC3A5MLED-x		5									
Y92E-M12PVC3A10MLED-x		10									
Y92E-MS08PVC3A2M-x	female (snap)	M8		PVC				Straight	2	no	Snap (PUR)
Y92E-MS08PVC3A5M-x									5		
Y92E-MS08PVC3S5M-x			5								
Y92E-MS08PVC4S5M-x			4		Straight	5					
Y92E-MS08PVC3A5MLED-x			3		Angled	5	yes				

¹ -L' or -H' are added to the product description

Detergent resistant models

Product description	Connector	Size	Cable material	Poles	Type	Length (m)	LED	Nut
Y92E-S08PVC4A2M-L	female	M8	PVC	4	Angled	2	no	SUS
Y92E-S08PVC4A5M-L					5			
Y92E-S08PVC4S2M-L					2			
Y92E-S08PVC4S5M-L					5			
Y92E-S12PVC4A2M-L		M12			Angled	2		
Y92E-S12PVC4A5M-L					5			
Y92E-S12PVC4C2M-L					2			
Y92E-S12PVC4S5M-L					5			

Specifications

Rated current	4 A
Rated voltage	M8 3 pin: 60 V M8 4 pin: 60 V (-H), 30 V (-L) M12 3- or 4-wire: 240 V M12 5-wire: 60 V with LED: 10-30 V
Degree of protection	IP67
Ambient temperature	-25 to +70 °C M8 and M12 (PVC cable) -25 to +80 °C M8 and M12 (PUR cable)
Specials	-H: Silicone-free PUR cable: Halogene-free

M8 pin assignment

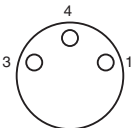
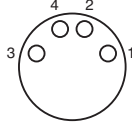
3 poles		4 poles	
	1 = brown 3 = blue 4 = black		1 = brown 2 = white 3 = blue 4 = black

M12 pin assignment

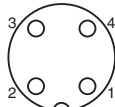
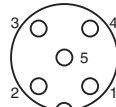
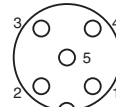
3 poles		4 poles		5 poles	
	1 = brown 2 = n.c. 3 = blue 4 = black		1 = brown 2 = white 3 = blue 4 = black 5 = n.c.		1 = brown 2 = white 3 = blue 4 = black 5 = green / yellow

Dimensions

General purpose
Y92E-M08□-L

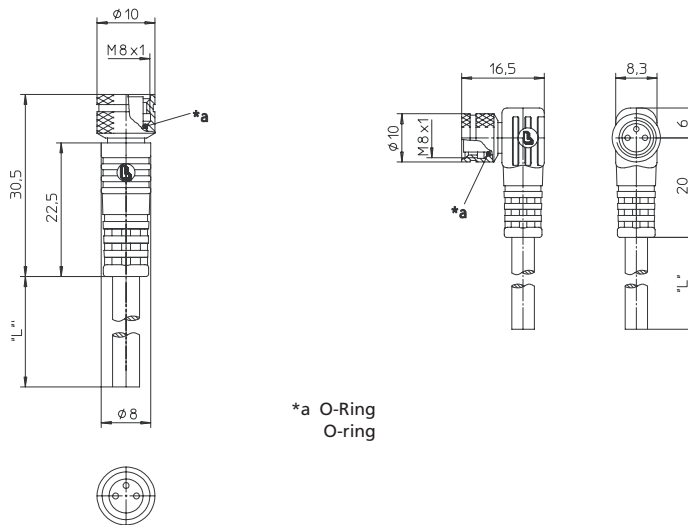

*a O-Ring
O-ring

Y92E-M08□-LED-L

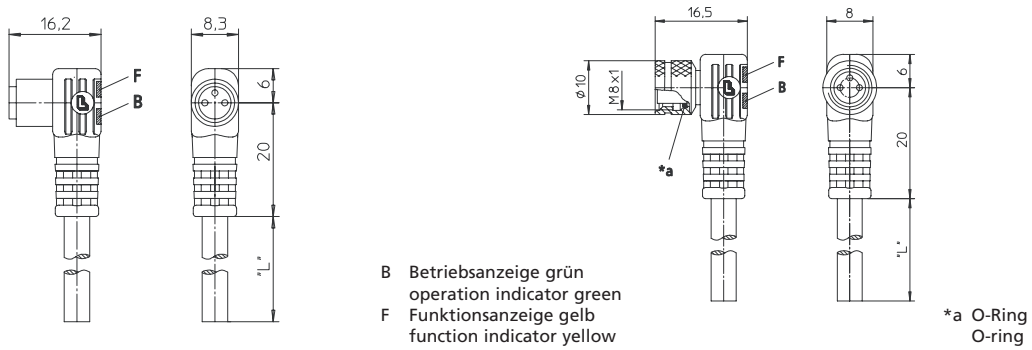

B Betriebsanzeige grün
operation indicator green
F Funktionsanzeige gelb
function indicator yellow

*a O-Ring
O-ring

Y92E-M12□-L

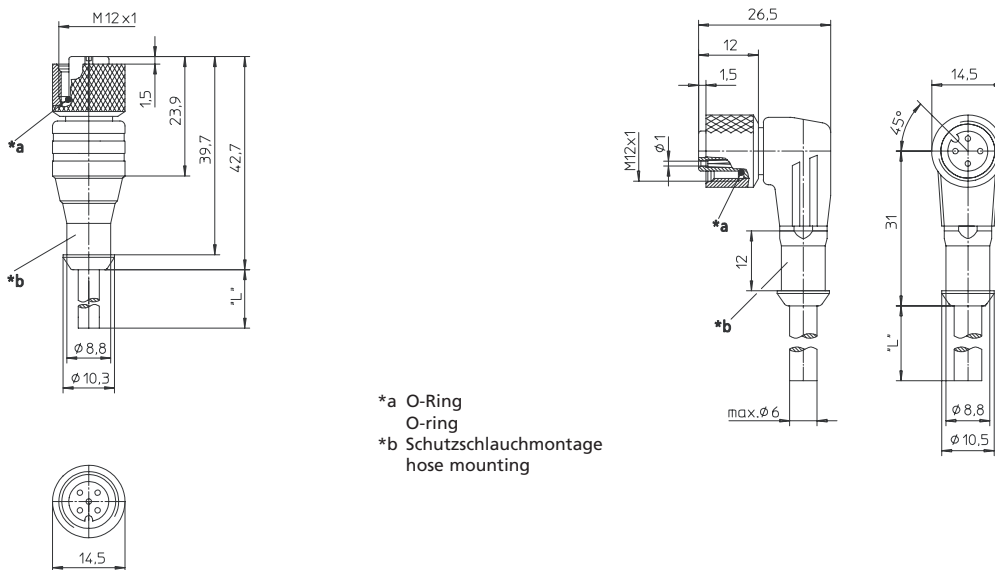

*a O-Ring
O-ring
*b Schutzschlauchmontage
hose mounting

Detergent resistant
Y92E-S08

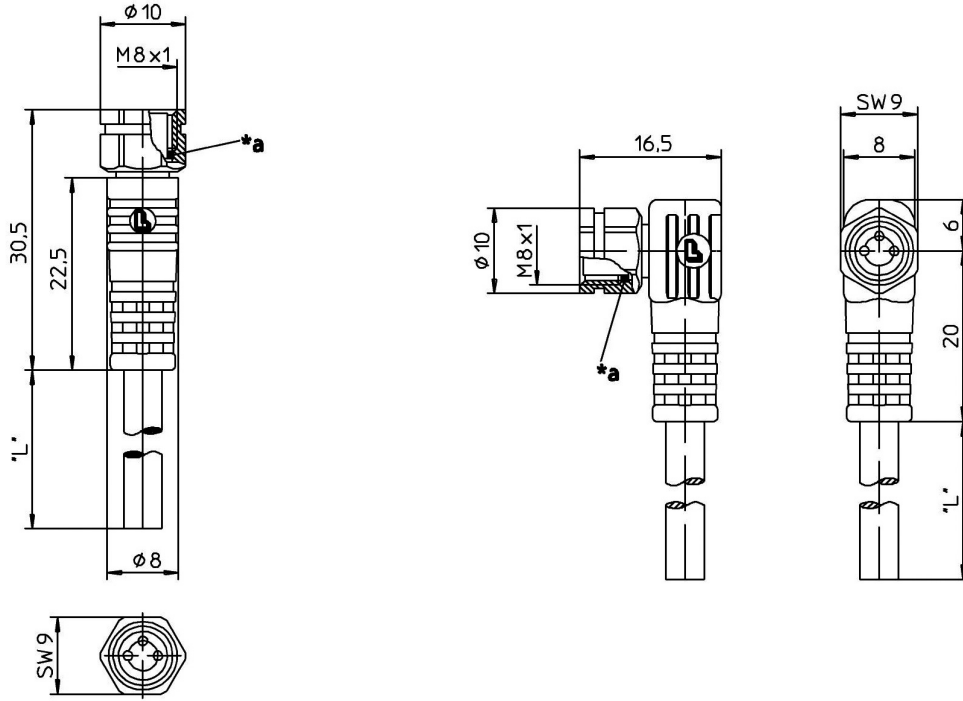

Y92E-S12

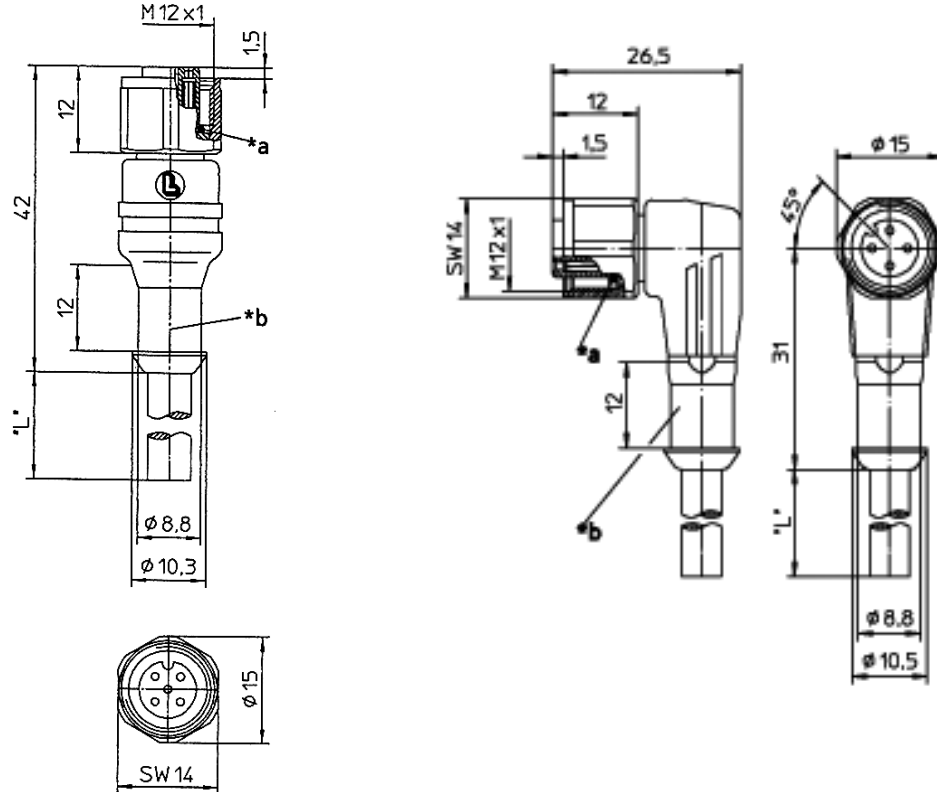

M12 Extended Wiring and Robot Cable Connectors

XS2F**Model Number Legend**

Use this model number legend to identify products from their model number. When ordering, use a model number from the table in *Ordering Information*.

XS2F - $\square\square\square$ **2** \square - $\square\square$ **0** - \square
 1 2 3 4 5 6 7 8 9

1. Type

F: Connector connected to cable, socket on one cable end

2. AC/DC (Mating Section Form)

A: For AC

D: For DC

3. Connector Poles

4: 4 poles

5: 5 poles

4. Contact Plating

2: 0.4- μ m gold plating

5. Cable Connection Direction

1: Straight

2: L-shaped (angled)

6. Cable Length

A: 0.3 m

B: 0.5 m

C: 1 m

D: 2 m

E: 3 m

F: 4 m

G: 5 m

H: 7 m

J: 10 m

K: 15 m

L: 20 m

Only the 2 m (D) and 5 m (G) cables are available for cables with 5 poles.

7. Connections

Pin No.

1 2 3 4

A: Brown --- --- Blue (for DC)

B: --- --- Brown Blue (for AC)

C: Brown --- Blue Black

8: Brown White Blue Black (for DC)

9: Brown White Blue Black (for AC)

Pin No.

1 2 3 4 5

G: Brown White Blue Black Gray

8. Connectors on One End/Both Ends

0: One end

9. Cable Specifications

A: Standard cable

R: Vibration-proof robot cable (straight/straight only)

F: Fire-retardant, vibration-proof cable

AS: Spatter proof

XS2F-□42□-□□0-A Connectors with Standard Cable (2, 3 or 4 wires)

XS2F-□42□-□□0-R Connectors with Vibration-proof Robot Cable

Ordering Information

Cable type	Cable connection direction	No. of cable cores	Core diameter	Cable length (m)	Model		UL-listed	
					DC	AC		
Standard cable	Straight	2	0.5 mm ²	2	XS2F-D421-DA0-A	XS2F-A421-DB0-A	---	
		3			XS2F-D421-DC0-A	---	---	
		4			XS2F-D421-D80-A	XS2F-A421-D90-A	Yes	
		2		5	XS2F-D421-GA0-A	XS2F-A421-GB0-A	---	
		3			XS2F-D421-GC0-A	---	---	
		4			XS2F-D421-G80-A	XS2F-A421-G90-A	Yes	
		2		10	XS2F-D421-JA0-A	XS2F-A421-JB0-A	---	
		3			XS2F-D421-JC0-A	---	---	
		4			XS2F-D421-J80-A	XS2F-A421-J90-A	Yes	
		L-shaped (angled)		2	2	XS2F-D422-DA0-A	XS2F-A422-DB0-A	---
					3	XS2F-D422-DC0-A	---	---
					4	XS2F-D422-D80-A	---	Yes
	5		2	XS2F-D422-GA0-A	XS2F-A422-GB0-A	---		
			3	XS2F-D422-GC0-A	---	---		
			4	XS2F-D422-G80-A	---	Yes		
	10		2	XS2F-D422-JA0-A	XS2F-A422-JB0-A	---		
			3	XS2F-D422-JC0-A	---	---		
	4	XS2F-D422-J80-A	---	Yes				
	Vibration-proof robot cable	Straight	2	0.5 mm ²	2	XS2F-D421-DA0-R	XS2F-A421-DB0-R	---
			4			XS2F-D421-D80-R	XS2F-A421-D90-R	---
2			5		XS2F-D421-GA0-R	XS2F-A421-GB0-R	---	
4					XS2F-D421-G80-R	XS2F-A421-G90-R	---	
2			10		XS2F-D421-JA0-R	XS2F-A421-JB0-R	---	
4					XS2F-D421-J80-R	XS2F-A421-J90-R	---	
L-shaped (angled)			2		2	XS2F-D422-DA0-R	XS2F-A422-DB0-R	---
			4			XS2F-D422-D80-R	---	---
		2	5		XS2F-D422-GA0-R	XS2F-A422-GB0-R	---	
		4			XS2F-D422-G80-R	---	---	
		2	10		XS2F-D422-JA0-R	XS2F-A422-JB0-R	---	
		4			XS2F-D422-J80-R	---	---	

Specifications

Rated current	3 A
Rated voltage	125 VDC, 250 VAC
Contact resistance	40 mΩ max. (20 mV max., 100 mA max.) (See note 1).
Insulation resistance	1,000 MΩ min. (at 500 VDC)
Dielectric strength	1,500 VAC for 1 min (leakage current: 1 mA max.) (See note 2).
Degree of protection	IP67 (IEC529)
Insertion tolerance	200 times min.
Assembled fixture strength	Tensile: 98 N/15 s Torsion: 0.98 N·m/15 s
Ambient temperature	Operating: -25°C to 70°C

Note: 1 . The contact resistance of the connector.
2 . The dielectric strength of the connector.

Materials and Finish

Item		XS2F	XS2R	XS2C/XS2G
Con- tacts	Materials	Phosphor bronze	Brass	
	Finish	Nickel base, 0.4-μm gold plating		
Fixtures	Materials	Brass (See note 1.)		
	Finish	Nickel plated (See note 1.)		
Pin Block	Materials	PBT resin (UL94V-0)	PA resin (UL94V-0)	PBT resin (UL94V-0)
	Finish	For DC: light gray; for AC: dark gray		
O-ring/rubber bush- ing		Rubber		
Cover		Polyester elastomer	---	PBT resin (UL94V-0)
Cap		---	---	PBT resin (UL94V-0)
Cable clamp		---	---	PA resin (UL94V-0)
Pin clamp		---	---	PBT resin (UL94V-0)
Lock spring		---	---	LCP resin (UL94V-0)
Watertight bushing		---	---	Rubber
Ring		---	---	Steel

Note: The T-joint of the XS2R is aluminum/white.

Socket Appearance

DC type		AC type	
Male contacts	Female contacts	Male contacts	Female contacts

Note: The AC and DC connectors are different as shown here and therefore cannot be connected together.

Dimensions

Straight Connectors

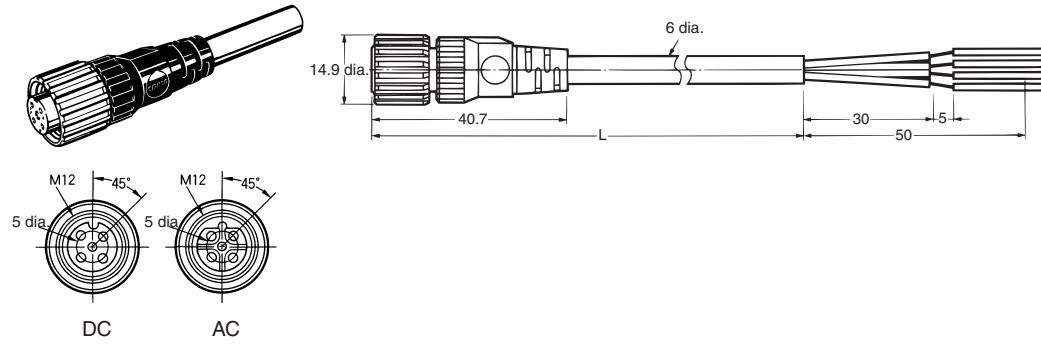

L-shaped Connectors

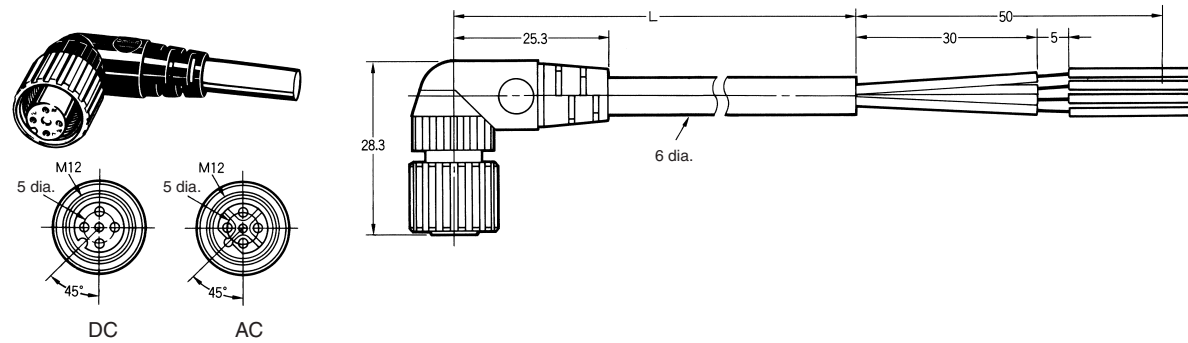

Wiring Diagram

Item	Standard cable
	Vibration-proof robot cable
	XS2F-□42□-□□0-A XS2F-□42□-□□0-R
Two-core model	
Three-core model	
Four-core model	

XS2

5-wire Connectors for DC

XS2F-D521-□G0-A

Ordering Information

Cable connection direction	No. of cable cores	Cable core cross-sectional area	Cable length (m)	DC
				Model
Straight	5	0.3 mm ²	2	XS2F-D521-DG0-A
			5	XS2F-D521-GG0-A

Dimensions

Straight Connectors

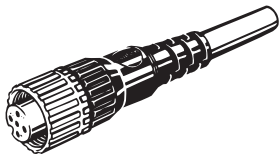

Note: Use the XS2F-D521-□G0-A in combination with the XS2H-D521-□G0-A.

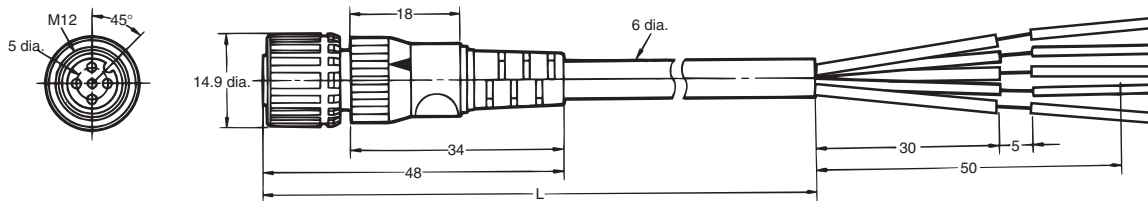

Wiring Diagram

Contact No.

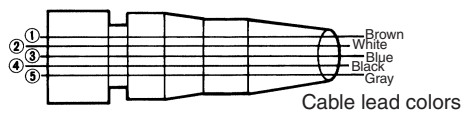

Pin Arrangements (Engagement Side)

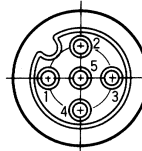

XS2 Connector Covers

Water-resistant Covers

XS2Z-11

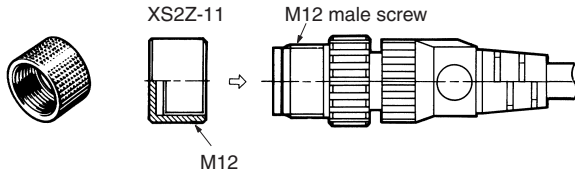

XS2Z-12

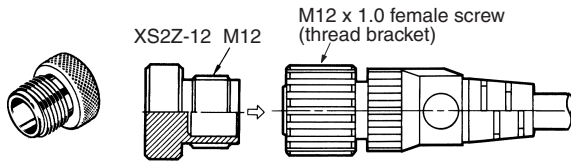

The Water-resistant Cover ensures IP67. When mounting the Water-resistant Cover to a Connector, be sure to apply a torque range between 0.39 and 0.49 N-m to tighten the Water-resistant Cover.

Ordering Information

Model	Minimum order	Material	Suitable connector	
			Model	Mounting portion
XS2Z-11	50	Brass/nickel plated	XS2R	M12 male screw
XS2Z-12			XS2R/XS2F/XW3B	M12 female screw (thread bracket)

Note: Orders are accepted in multiples of the minimum order.

Dust Covers

XS2Z-13

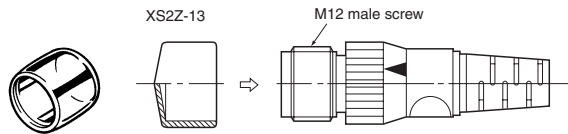

The Dust Cover is for dust prevention and does not ensure IP67 degree of protection. When mounting the Dust Cover to a connector, be sure to press the Dust Cover onto the Connector until the Connector is fully inserted into the Dust Cover.

XS2Z-15/XS1Z-14

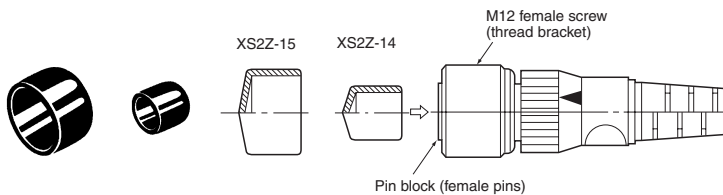

Ordering Information

Model	Minimum order	Material	Suitable connector	
			Model	Mounting portion
XS2Z-13	50	Transparent polyvinyl chloride	XS2R	M12 male screw
XS2Z-14		Red polyvinyl chloride		Pin block (female pins)
XS2Z-15			XS2R/XS2F/XW3B	M12 female screw (thread bracket)

Note: Orders are accepted in multiples of the minimum order.

M8 Small Size and Robot Cable Connectors

XS3F

Model Number Legend

Use this model number legend to identify products from their model number. When ordering, use a model number from the table in *Ordering Information*.

XS3F - □42□ - **4**□□□ - □
1 2 3 4 5 6 7 8 9

1. Fastening Method

M: M8
 S: S8

2. Connector Poles

4: 4 poles

3. Cable Connection Direction

1: Straight
 2: L-shaped

4. Connections

Pin No.
 1 2 3 4
 4: Brown White Blue Black

5. Cable Length

01: 1 m
 02: 2 m
 05: 5 m

6. Cable Specifications

A: Standard cable
 R: Vibration-proof robot cable

Ordering Information

M8 Model

Item	Cable connection direction	No. of cable cores	Cable core cross-sectional area	Cable length (m)	Model
Standard cable	Straight	4	0.2 mm ²	2	XS3F-M421-402-A
				5	XS3F-M421-405-A
	L-shaped			2	XS3F-M422-402-A
				5	XS3F-M422-405-A
Vibration-proof robot cable	Straight	4		1	XS3F-M421-401-R
				2	XS3F-M421-402-R
				5	XS3F-M421-405-R
	L-shaped			1	XS3F-M422-401-R
			2	XS3F-M422-402-R	
			5	XS3F-M422-405-R	

S8 Model

Cable connection direction	No. of cable cores	Cable core cross-sectional area	Cable length (m)	Model
Straight	4	0.2 mm ²	1	XS3F-S421-401-R
			2	XS3F-S421-402-R
			5	XS3F-S421-405-R
L-shaped			1	XS3F-S422-401-R
			2	XS3F-S422-402-R
			5	XS3F-S422-405-R

Specifications

Rated current	1 A
Rated voltage	125 VDC
Contact resistance	40 MΩ max. (20 mV max., 10 mA max.) (See note 1.)
Insulation resistance	1,000 MΩ min. (at 500 VDC)
Dielectric strength	1,000 VAC for 1 min (leakage current: 1 mA max.) (See note 2.)
Degree of protection	IP67 (IEC529)
Insertion tolerance	200 times
Cable tensile strength	50 N/15 s)
Ambient temperature	Operating: -25°C to 70°C

Note: 1 . The contact resistance of the connector.
2 . The dielectric strength of the connector.

Materials and Finish

Pin Block	PBT resin/light gray or black
Contacts	Brass/nickel base, 0.4-μm gold plating
Thread bracket (M8) Shell (S8)	Brass/nickel plated
Cover	Thermoplastic elastomer/black
O-ring	Rubber

Pin Arrangement (Engaged Side)

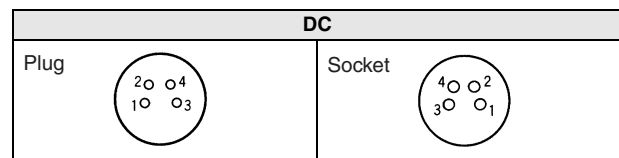

Dimensions

M8 Screw-on cable connectors

Straight Connectors

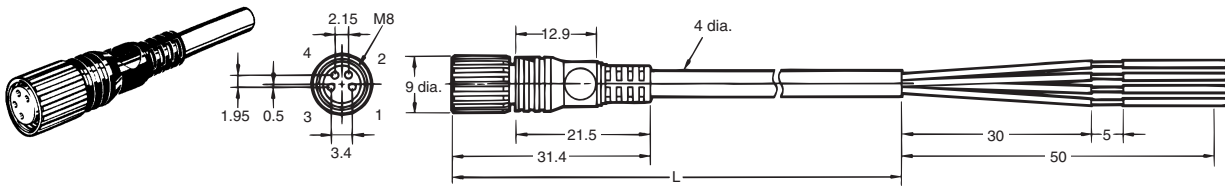

L-shaped Connectors

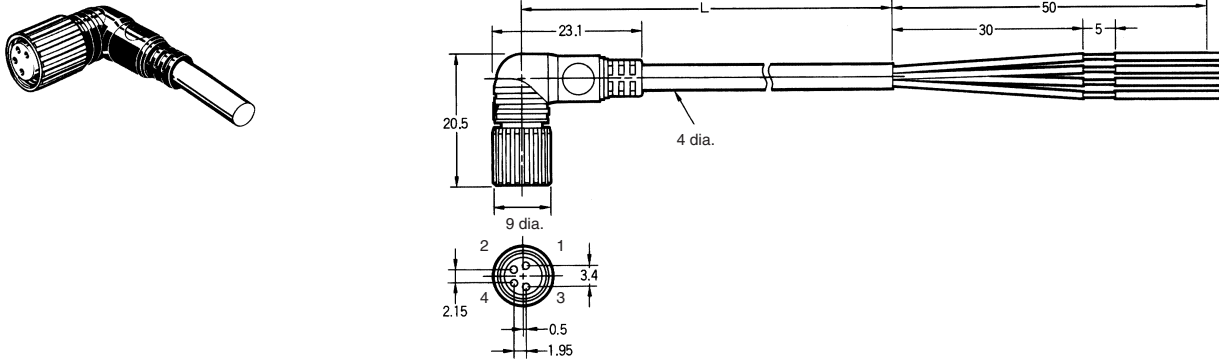

Wiring Diagram

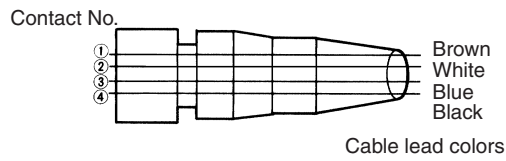

Dimensions

M8 Snap-in cable connectors

Straight Connectors

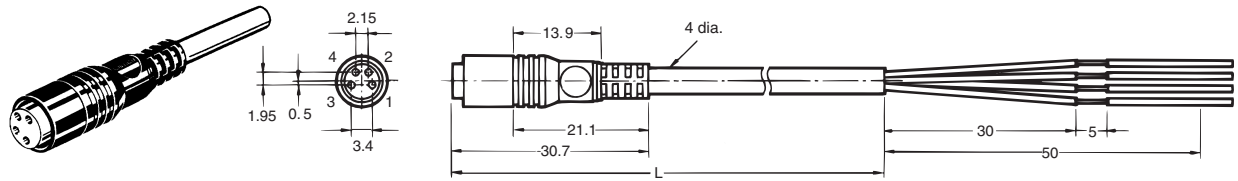

L-shaped Connectors

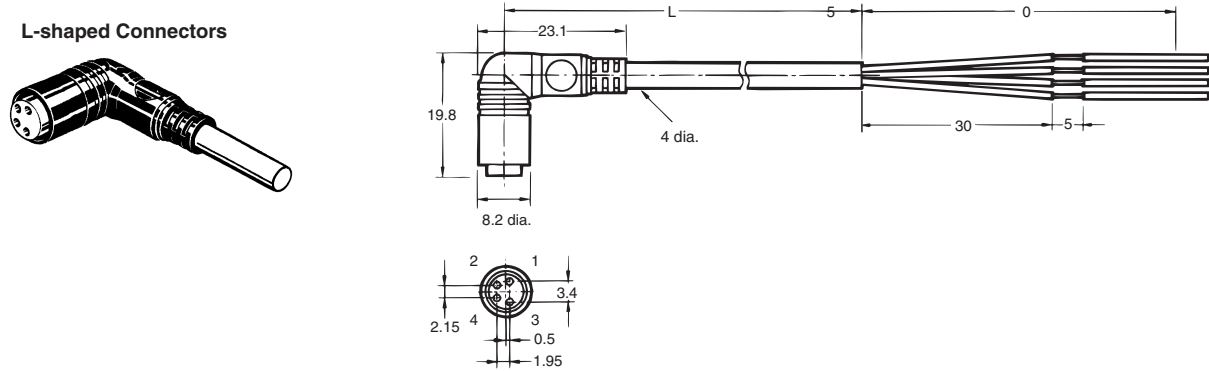

Wiring Diagram

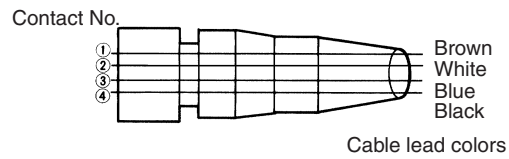

XS3

Precautions

Refer to *Correct Use* for precautions for individual products.

Correct Use

Connections

- The XS3 and XS2 Sensor I/O Connectors cannot be connected to each other.
- When using Sensors with Connectors or Limit Switches, use the Sensor I/O Connectors specified in the catalog.
- Do not connect M8 screw models and S8 snap-in models together, otherwise the proper degree of protection of the Connectors will not be maintained.

Connector Connection and Disconnection

- Before connecting or disconnecting Connectors, make sure that no power is being supplied to the Connectors.
- When connecting or disconnecting Connectors, be sure to hold the Connectors by hand.
- Do not touch the engagement side of any Connector with wet hands. If there is any water on the Connector or near the Connector, be sure to wipe off the water before connecting or disconnecting the Connector, otherwise the Connector may short-circuit internally or not ensure good insulation.
- Make sure that engagement side of any Connector is free of metal dust or power.
- Do not use pliers to tighten mounting the thread bracket, otherwise the thread bracket may be damaged. Be sure to tighten each thread bracket by hand within a torque of 0.3 and 0.4 N·m. If the thread bracket is not tightened securely, the Connector may not maintain its proper degree of protection or the thread bracket may fall off due to vibration.
- Fully insert S8 snap-in models until the Connectors are hidden by the metal casing of the opposite parts, otherwise the Connectors will not maintain their proper degree of protection or the thread brackets may drop off due to vibration.

Cable Wire Color

- The M8/S8 Sensor I/O Connectors use the following lead wire colors.

Model		Pin No.			
		1	2	3	4
DC	8-mm-dia. DC4	Brown	White	Blue	Black

Degree of Protection

- Do not impose external force continuously on the joints of pin blocks and covers, otherwise the Connectors may not keep its proper degree of protection (i.e., IP67).
- Connectors are not fully watertight. Do not use them underwater.
- The Connectors are not oil-resistant. Do not use them where they would be subject to oil.
- If Connectors are used in places with vibration or shock, secure the engaged side of each Connector, otherwise the Connectors may be disconnected or fail to maintain their proper degree of protection.
- Connectors are of resin mold construction. Do not impose excessive force on them.





Storage

Do not store Connectors for long periods of time in the following locations

- Locations subject to dust or high humidity
- Locations subject to ammonia gas or sulfide gas

Connector terminal boxes and extended wiring accessories

Overview

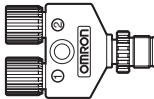
Shape	Product group	Type	Housing material	Features	Key specifications	Order reference	Applicable Sensors	
	Extended wiring accessories	M12 I/O connector terminal boxes	- PBT case - brass connectors	- flat size - for M12 connectors - 4, 6 or 8 contacts per box	- 4 A / port - 10 or 30 V DC - 4 or 5-pin - IP67	XW3B	for all sensors connected via M12 4-pin connections & cables	
		I/O connector terminal boxes for bus connection	Please contact your OMRON representative for our large portfolio of remote I/O					
		Waterproof cover for M12 I/O connector	brass	water proof cover for IP67 rating of X3WB			XS2Z-12	
		M12 T-joint and Y-joint plugs	- PVC cable - brass nut	- daisy chain model for 'AND' configurations (T-joint) - direct wiring models for 'OR' configurations (Y-joint) - bifurcate models for signal splitting - aggregate models for reduced wiring	- 3 A rated current - DC - 4-pin - IP67		XS2R	- sensors with built-in M12 4-pin connector (-M1) - sensors with M12 4-pin cable end connector (-M1J)
		M8 Y-joint plugs	- PBT case - brass connectors	- direct wiring models for 'OR' configurations - aggregate models for reduced wiring	- 1 A rated current - 125 V DC - 4-pin - IP67		XS3R	- sensors with built in M8 4-pin connector (-M3) - sensors with M8 4-pin cable end connector

Note: 1 . Please contact your OMRON representative for these models

M12 Connector Terminal Boxes

XW3B

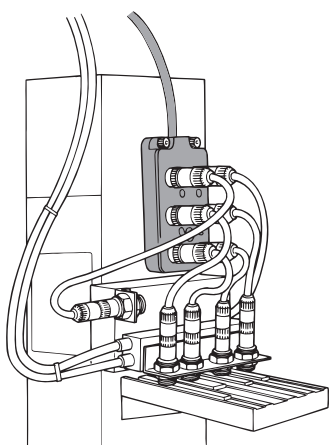
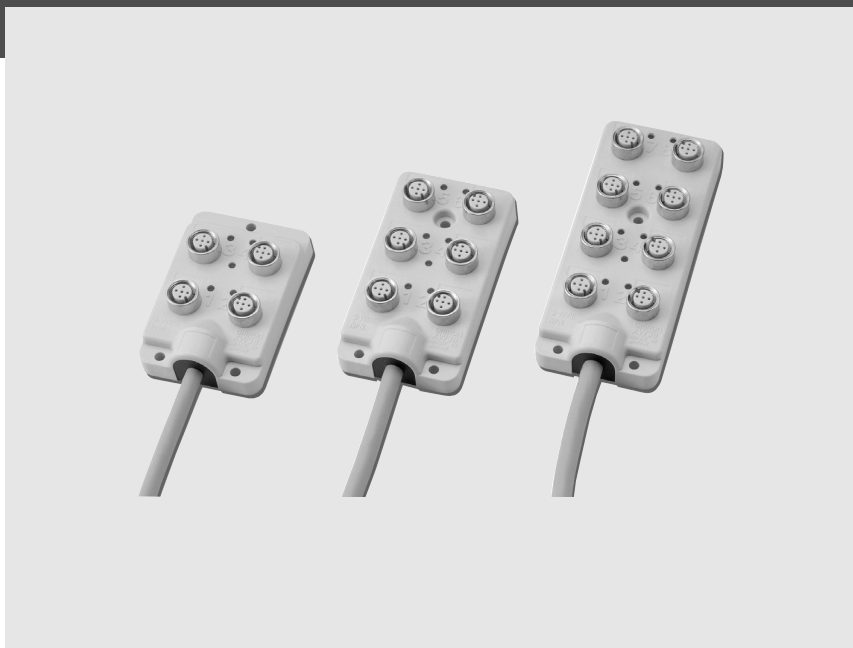

Ratings and Characteristics

Rated current	4 A/port (signal lines) 12 A/box (power lines)
Rated voltage	10 to 30 VDC
Contact resistance	40 MΩ max. (with 100 mA max., 20 mV max.) (See note 1.)
Insulation resistance	100 MΩ min. (at 500 VDC)
Dielectric strength	500 VAC for 1 min (leakage current: 1 mA max.) (See note 2.)
Degree of protection	IP67 (IEC529)
Cable retention force	98 N/15 s
Insertion tolerance	200 times
Operating temperature	-25 to 70°C

Note: 1 . The contact resistance of the Connector.
2 . The dielectric strength of the Connector.

Materials and Finish

Item	Part name	Materials and finish
Connectors	Anchor	Brass/nickel plated
	Contacts	Brass/nickel base, 0.4-μm gold plating
Cable	Cable	Sheath color: gray Core size: AWG18/AWG22 (See note.)
Case	Case	PBT resin (UL94V-0)/light gray
	Bushing	Rubber
	PCB	Glass-epoxy board
	Seal resin	Urethane resin

Note: The positive power supply, negative power supply, and ground lines are AWG18. Signal lines are AWG22.

Compatible Connectors *1

XS2G	Connector Plug Assemblies (crimping, soldering, or screw-on)
XS2W	Connectors on cable ends (Sockets or Plugs)
XS2H	Connectors on one cable end (Plugs)

Note: 1 . Please refer to separate datasheet X073-E1-01 for these models.

Ordering Information

Sensor type and connections		3-wire DC NPN/2-wire 3-4	2-wire DC1-4/without polarity 3-4	3-wire DC PNP/2-wire DC 1-4
Actuator connections		Actuator connections 1-4	---	Actuator connections 3-4
No. of ports	Cable length (m)	Model	Model	Model
4	5	XW3B-P455-G11	XW3B-P452-G11	XW3B-P453-G11
6	5	XW3B-P655-G11	XW3B-P652-G11	XW3B-P653-G11
8	5	XW3B-P855-G11	XW3B-P852-G11	XW3B-P853-G11

Note: Here 1-4 and 3-4 are connector pin numbers.

Waterproof Cover (Sold Separately)
XW2Z-12



Model	Materials
XW2Z-12	Brass/nickel plated

Note: The XW3B/XW3A comes with a dust cover. Use the optional XW2Z-12 Waterproof Cover when an IP67 degree of protection is required.

Connection Diagram

Standard Japanese Specification

XW3B-P□55-G11 for 3-wire DC NPN, 2-wire DC (without polarity 3-4), and Actuator (1-4)

Japanese Specification

XW3B-P□52-G11 for 2-wire DC (with polarity 1-4, without polarity 3-4)

Note: Cannot be used with NPN-type Photoelectric and Proximity Sensors. Cannot be used with Proximity Sensors with polarity 3-4.

European Specification

XW3B-P□53-G11 for 3-wire DC PNP, 2-wire DC (with polarity 1-4), and Actuator (3-4)

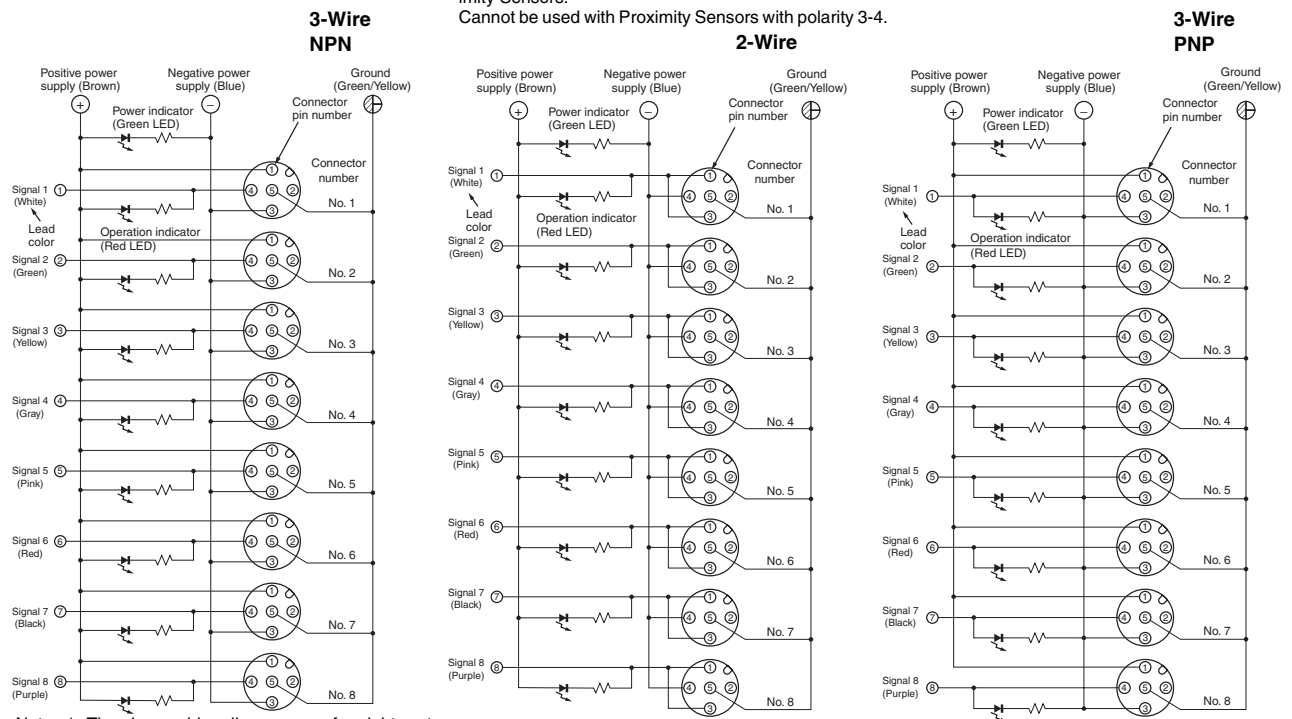

- Note:
1. The above wiring diagrams are for eight-port use.
 2. Figures in parentheses indicate lead colors.
 3. The expression "white/red" means white and red stripes.
 4. Here 1-4 and 3-4 are pin numbers.
 5. Contact numbers 5 through 8 in the above diagrams do not exist on Terminal Boxes with four inputs. The lead colors for signals 1 through 4, power supply, and ground are the same.
 6. Contact numbers 7 and 8 in the above diagrams do not exist on Terminal Boxes with six inputs. The lead colors for signals 1 through 6, power supply, and ground are the same.

Dimensions

XW3B-P45□-G11 (Four Input Ports)

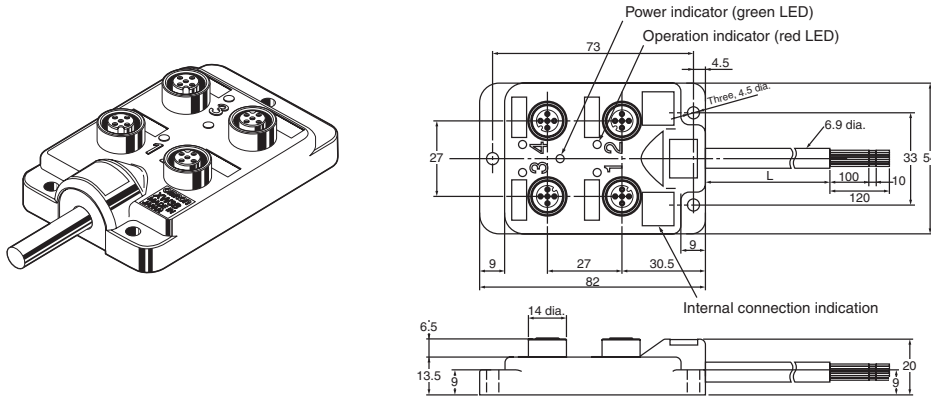

XW3B-P65□-G11 (Six Input Ports)

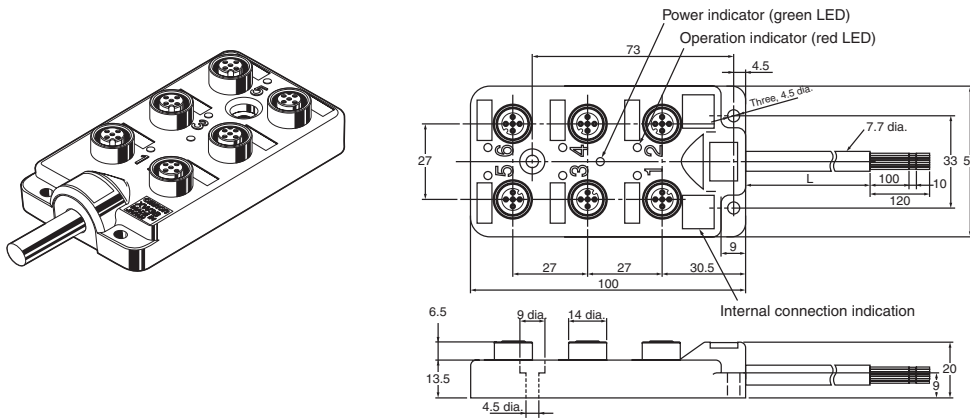

XW3B-P85□-G11 (Eight Input Ports)

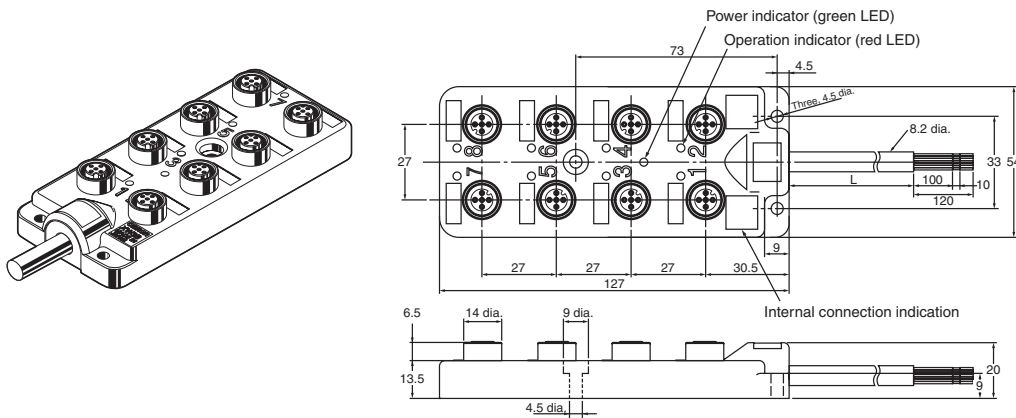

Mounting holes

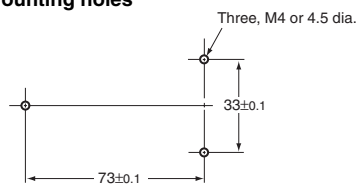

Note: Mounting hole dimensions are always the same regardless of the number of ports.

M12 Y-Joint and T-Joint Plug / Socket Connectors

XS2R

Ordering Information

Type	Connector	DC	
		Cable length L (m)	Model
With cable	Connectors on cable ends	0.5	XS2R-D426-B11-F
		1	XS2R-D426-C11-F
		2	XS2R-D426-D11-F
		3	XS2R-D426-E11-F
	Connector on one cable end	2	XS2R-D426-D10-F
5		XS2R-D426-G10-F	
Without cable	Y-Joint plug/socket	---	XS2R-D426-1
		---	XS2R-D426-5
		---	XS2R-D426-81
		---	XS2R-D426-82

Note: Orders are accepted in multiples of the minimum order.

Dimensions

XS2R-D426-□11-F Connectors on Cable Ends (Y-Joint Plug/Socket)

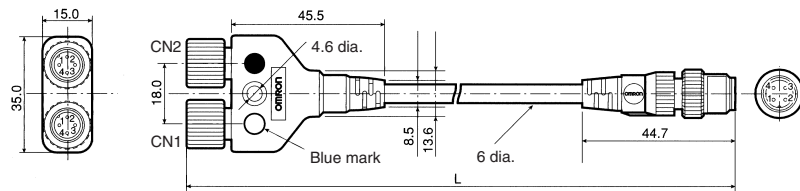

Internal Connections

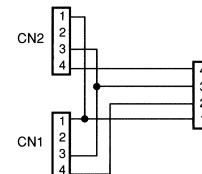

XS2R-D426-□10-F Connectors on One Cable End (Y-Joint Plug/Socket)

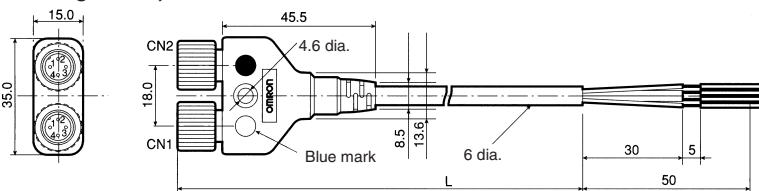

Internal Connections

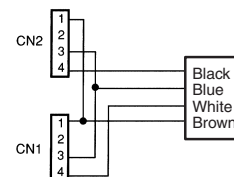

XS2R-D426-1 Y-Joint Plug/Socket without Cable

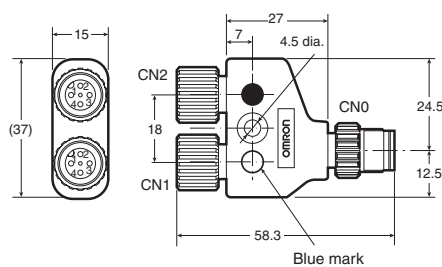

Internal Connections

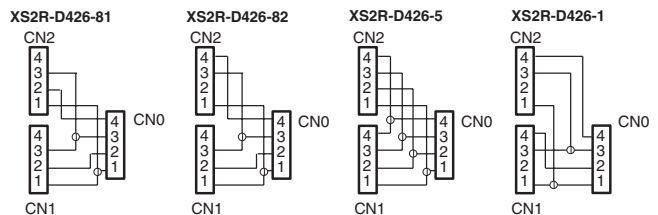

Ordering Information

Type	DC
	Model
Aggregate model	XS2R-D422-1
	XS2R-D422-5
Bifurcated model	XS2R-D423-1
Daisy-chain model	XS2R-D424-1

Dimensions

XS2R-D422-1
XS2R-D422-5
Aggregate Models

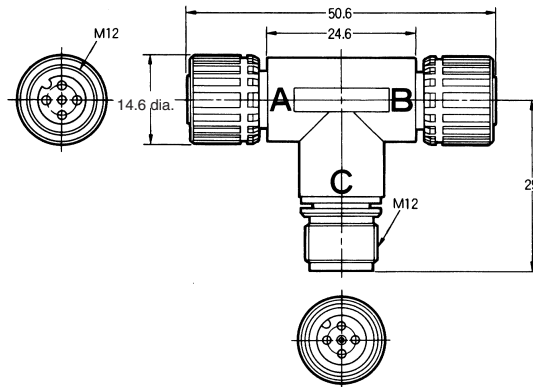
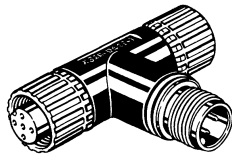

Internal Connections
XS2R-D422-1

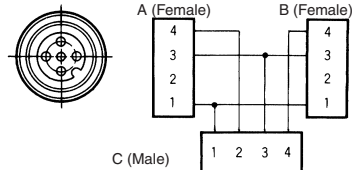

XS2R-D422-5

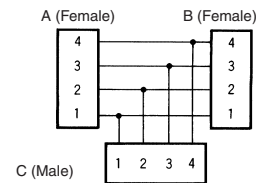

XS2R-D423-1
Bifurcated Model

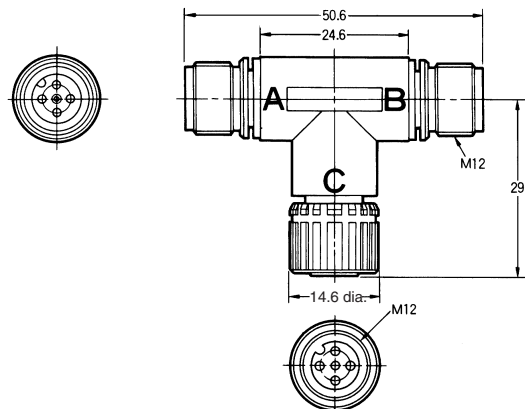
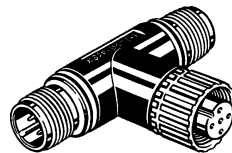

Internal Connections

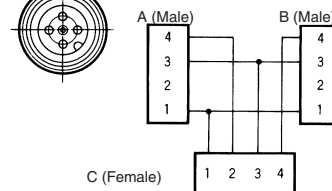

XS2R-D424-1
Daisy-chain Model

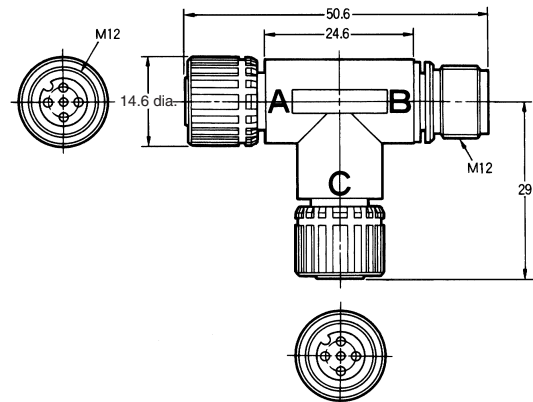
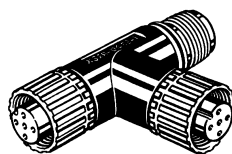

Internal Connections

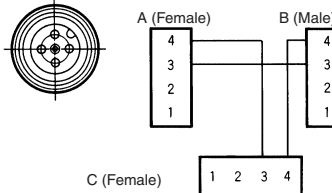

Precautions

- Before using the XS2R for Sensors, make sure that the wiring of the Sensors and the internal connections of the XS2R are correct.

XS2R Application Examples

XS2R-D422-1 (Aggregate Model)

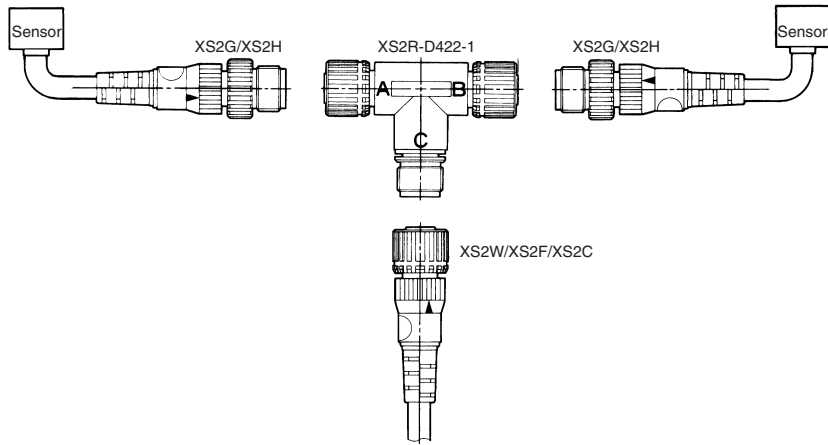

A pair of Two-wire Sensors or Three-wire Sensors can be connected as shown in the illustration. The XS2R-D422-5 has feed-through connections, thus working as a connector for the extension cable.

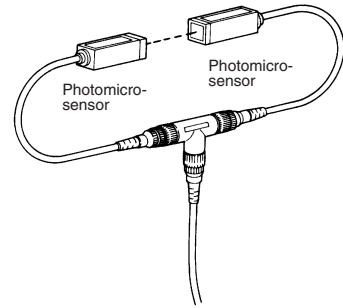

XS2R-D423-1 (Bifurcated Model)

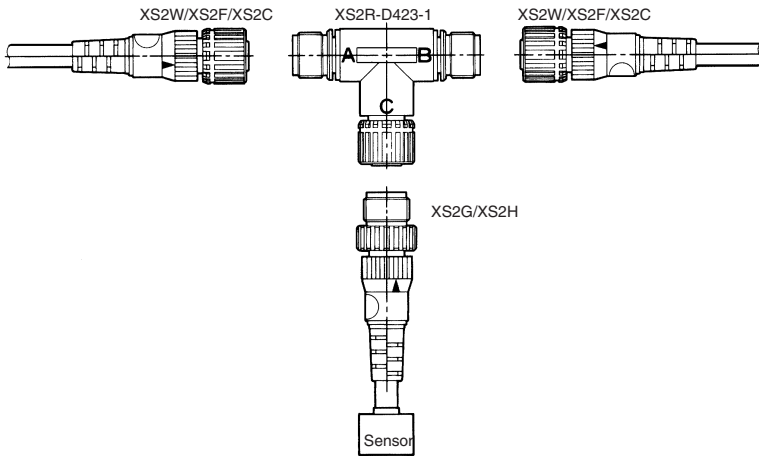

Two or Three-wire Sensor signals can be bifurcated.

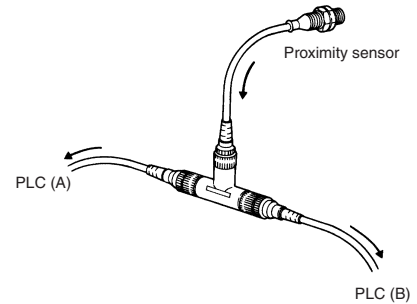

XS2R-D424-1 (Daisy Chain Model)

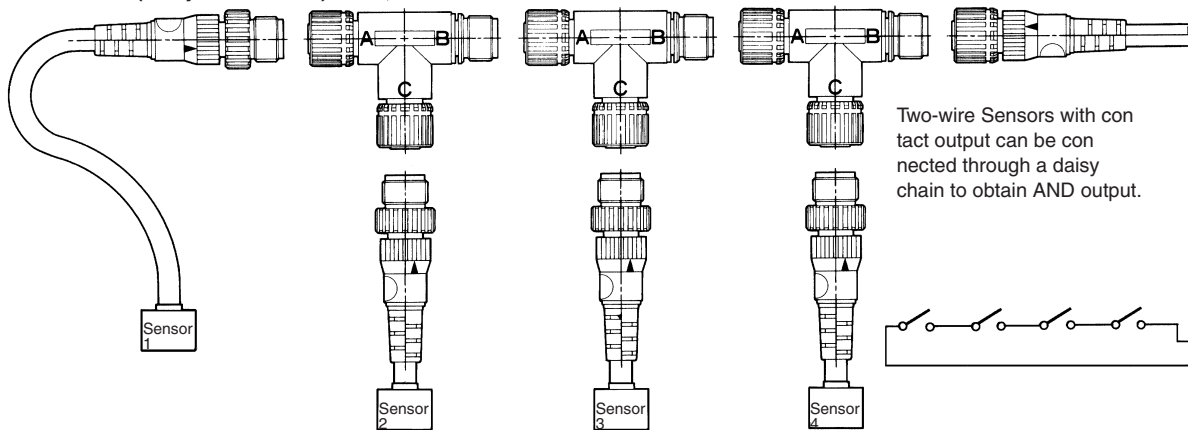

Two-wire Sensors with contact output can be connected through a daisy chain to obtain AND output.

M8 Y-Joint Plug / Socket Connectors

XS3R

Ratings and Characteristics

Rated current	1 A
Rated voltage	125 VDC
Contact resistance	60 MΩ max. (20 mV max., 100 mA max.) (See note 1.)
Insulation resistance	1,000 MΩ min. (at 500 VDC)
Dielectric strength	1,000 VAC for 1 min (leakage current: 1 mA max.) (See note 2.)
Degree of protection	IEC IP67
Insertion tolerance	200 times min.
Ambient temperature	Operating: -25°C to 70°C

Note: 1. The contact resistance of the connector.
2. The dielectric strength of the connector.

Materials and Finish

Pin Block	PBT resin (UL94V-0)/light gray
Contacts	Phosphor bronze/nickel base, 0.4-μm gold plating
Thread bracket (M8) Shell (S8)	Brass/nickel plated
Cover	Polyester elastomer (UL94-0)/black
O-ring	Rubber

Ordering Information

Cable	Connector	For M8 Connectors	
		Cable length L (m)	Model
With cable	Connectors on cable ends	0.5	XS3R-M426-1C51-A
		1	XS3R-M426-1011-A
		2	XS3R-M426-1021-A
		3	XS3R-M426-1031-A
		5	XS3R-M426-1050-A
Without cable	Connectors on both ends	2	XS3R-M426-1020-A
		5	XS3R-M426-1050-A
		---	XS3R-M426-1 XS3R-M426-5

Dimensions

XS3R-M426-1□□1-A

Connectors on Cable Ends (Y-Joint Plug/Socket)

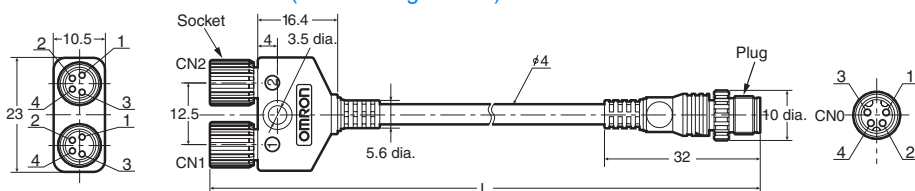

Wiring Diagram

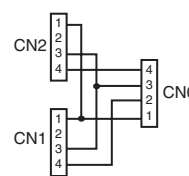

XS3R-M426-1□□0-A

Connector on One Cable End (Y-Joint Plug/Socket)

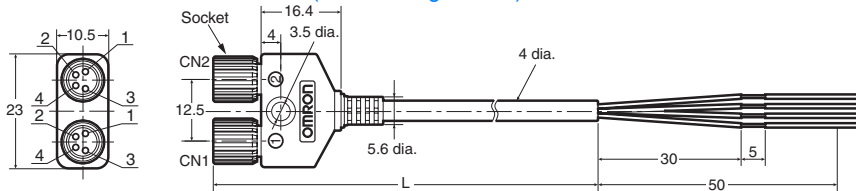

Wiring Diagram

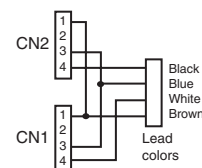

XS3R-M426-□
Connector on Both Ends (Y-joint Plug/Socket) without Cable

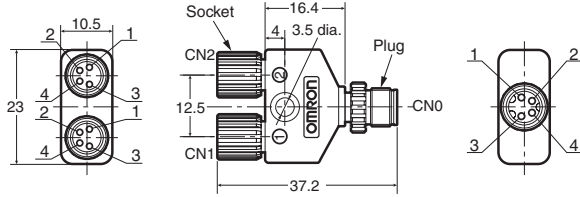

Wiring Diagram
XS3R-M426-1 XS3R-M426-5

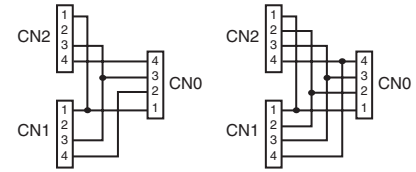

Accessories

XS3 M8/S8 Connector Cover (Order Separately)

Dust Cover

XS3Z-13

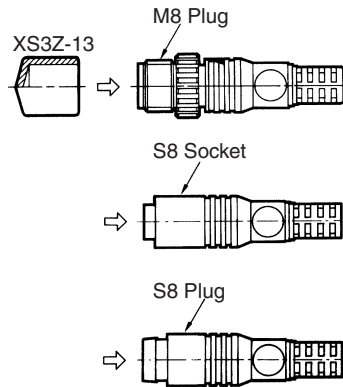

XS3Z-15

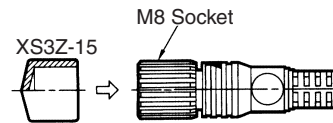

The Dust Cover is for dust prevention and does not ensure IP67. When mounting the Dust Cover to a Connector, be sure to press the Dust Cover onto the Connector until the Connector is fully inserted into the Dust Cover.

Ordering Information







Model	Material	Suitable connector	
		Model	Mounting portion
XS3Z-13	Polyvinyl chloride/red	XS3F	S8 socket
XS3Z-15	Polyvinyl chloride/red	XS3F	M8 socket

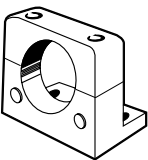

Accessories for Standard Photoelectric, Inductive and Capacitive Sensors

Accessories

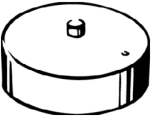
Mounting brackets, covers, slits and adjustment aids

For cylindrical shapes

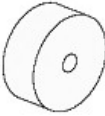



Shape	Product group	Type	Housing material	Features	Order reference	Applicable sensors
	Mounting brackets	general purpose - screw fix	plastic	- cost efficient mounting bracket - for M8, M12, M18, M30 - surface mounting	Y92E-B	-E3F2 -E2A -E2F
				for dia 34 mm	Y92E-A34	E2K-C
		quick access - snap fix	- snap fix for quick sensor access - for M8, M12, M18, M30 - surface mounting	Y92E-BC	-E3F2 (metal housing) -E2A (metal housing)	
		quick access - clamp fix	stainless steel	- clamp fix for quick sensor access with exact repositioning - for M8, M12, M18, M30 - through mounting	Y92E-G	
	Protective covers	general purpose sensor head protection	polyarylate	- for M8, M12, M18, M30 - for shielded and unshielded	Y92E-E	-E2A (-E2F)
		sputter protection for sensor head	silicone rubber	- increased protection in weld fields - for M12, M18, M30 - for shielded	Y92E□-2	
		general purpose lens protection	metal rim with glass cover		E39-F31	E3F2





Shape	Product group	Type	Housing material	Features	Order reference	Applicable sensors
	Slits	slit cover	polyarylate	- slit cover for precision detection and positioning with through beam photo sensors - for M18	Y92E-ES18	E3F2-10
		Adjustment aid for sensitivity adjuster	Polycarbonate		E39-G2	photo electric sensors with adjustable potentiometers



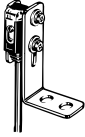

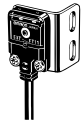
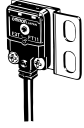
Accessories for photoelectric sensors

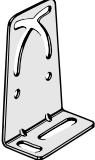





For square shapes

Mounting and protection



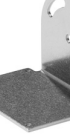

Shape	Type	Housing material	Features	Mounting type	Order reference	Applicable Sensors
	General purpose mounting	Stainless steel (SUS 304)	inclination angle adjustment	side wall mounting	E39-L43	E3Z
				back wall mounting	E39-L44	
			horizontal and inclination angle adjustment	surface mounting	E39-L104	
			back wall mounting	E39-L117	E3T-S	
			surface mounting	E39-L116		

Shape	Type	Housing material	Features	Mounting type	Order reference	Applicable Sensors
	General purpose mounting	Stainless steel (SUS 304)	-	back wall mounting	E39-L119	E3T-F
			-	side wall mounting	E39-L120	
			horizontal angle adjustment	back wall mounting	E39-L132	E3G-R
			side and back wall mounting	E39-L131		
			inclination angle adjustment	surface mounting	-E39-L139 -E39-L140	
			surface and back wall mounting (depending on sensor model)	-E39-L87 -E39-L102 -E39-L103	E3S-C	

Shape	Type	Housing material	Features	Mounting type	Order reference	Applicable Sensors
	General purpose mounting	Stainless steel (SUS 304)	3D rotation	surface, side and backwell mounting	E39-EL4	E3G, E3MC, E3S-A, E3S-C, E3Z
					E39-EL5	E3S-LS, E3S-B, E3T, E3Z, E3C
					E39-EL6	
	Side protection		inclination angle adjustment	protective side wall mounting	E39-L118	E3T-S

Shape	Type	Housing material	Features	Mounting type	Order reference	Applicable Sensors
	Full protection	Stainless steel (SUS 304)	inclination angle adjustment	protective side wall mounting	E39-L142	E3Z (pre-wired types)
					E39-L144	
			horizontal angle adjustment	protective surface mounting	E39-L98	-E3Z -E3S-C (horizontal)
					E39-L97	E3S-C (vertical)
	Telescope mounting	Stainless steel (SUS 304)	- 360° horizontal rotation - max telescope length	side and back wall mounting	-E39-L150 -E39-L151	-E3Z -E39-R3
			3D rotation around x, y, and z-axis	side wall, back wall and surface mounting	E39-L93	
			Extension pipe with XY joint	pipe mounting	E39-L93XY	E39-L93
			Reflector adapter for E39-L93	telescope mounting	E39-L96	-E39-R1 -E39-R1S

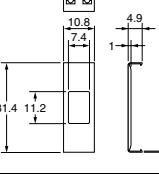
Slit, filters and other accessories

Shape	Type	Features	Mounting type	Order reference	Applicable Sensors
				E39-S65	E3Z-T
	Precision detection slit cover	- slit width from dia 0.5 mm for min object size detection of dia 0.2 mm	snap on	-E39-S63 -E39-S64	E3T-□T
				E39-S61	E3S-CT
	Mutual interference prevention	polarizing filter for close mounting of multiple sensors		E39-E11	E3Z-T□A
	Adjustment aid	adjustment aid for sensitivity adjustment		E39-E10	E3T-ST1

Reflectors for Retroreflective Photoelectric Sensors

E39-R















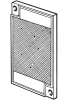

Product group	Photo electric sensor accessories				
					
Type	General purpose reflectors			Small size	
Housing material	-ABS base -Acrylic surface				
Features	Surface screw mounting (diagonal holes)	Surface screw mounting (holes on one side only)		Side screw mounting or surface selfadhesive	Surface screw mounting
Key specifications	size: 59.9 x 40.3 x 7.5	size: 35.4 x 42.3 x 8	size: 51.4 x 60.3 x 8.5	size: 41.8 x 22.5 x 11	size: 23 x 13.7 x 4.9
Order reference	E39-R1S	E39-R9	E39-R42	E39-R3	E39-R4
Applicable sensors	- Retroreflective photo electric sensors - non polarizing - Retroreflective photo electric sensors - polarizing (MSR)				

Photo electric sensor accessories							
							
Large size		High precision			Simple mounting	Harsh environments reflectors	Non-fogging reflector
-ABS base -Acrylic surface						- Mounting plate stainless steel - Reflector acrylic	- ABS - Acrylic surface
Surface screw mounting		Microtripel for improved performance with small beam sensors			Round shape with centered mounting hole for simple screw mounting	Direct mount or bracket mount	Anti-fogging coating
size: 100 x 100 x 9	size: 84.5 x 84.5 x 8.7	size: 52 x 40 x 4.8	size: 30 x 45 x	size: 12 x 24 x	Diameter: 84 Depth: 7.4	size: 14 x 13 x 1 IP67	size: 40 x 60 x 7.5
E39-R8	E39-R40	E39-R6	E39-R12	E39-R13	E39-R7	E39-R37	E39-R1K
- Retroreflective photo electric sensors - non polarizing - Retroreflective photo electric sensors - polarizing (MSR)		Recommended for fine beam and laser sensors (E3S-CR62/67, E3C, E3X)			Polarizing and non-polarizing photoelectric sensors	Recommended for harsh environment sensors (e.g. E3F2-R□-S, E3S-CR, E3ZM)	

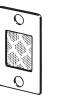
Product group	Photo electric sensor accessories						
							
Type	General purpose tape reflectors					High precision tape reflectors	
Housing material	Acrylic						
Features	- Self adhesive - Pre cut			-self adhesive -self cut / roll material		- Self adhesive - Pre cut	
Key specifications	size: 35 x 10 x 0.6	size: 40 x 35 x 0.6	size: 80 x 70 x 0.6	size: 25 mm x 5 m size: 25 mm x 22.8 m	size: 50 mm x 5 m size: 50 mm x 22.8 m	size: 195 x 22 x	size: 108 x 46 x
Order reference	E39-RS1	E39-RS2	E39-RS3	E39-RS25	E39-RS50	E39-RS4	E39-RS5
Applicable sensors	Polarizing and non-polarizing photoelectric sensors					Recommended for fine beam and laser sensors (E3S-CR62/67, E3C, E3X)	

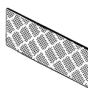
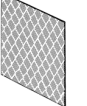
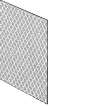
Reflectors dimensions (unit: mm)

E39-R1S
E39-R1K *

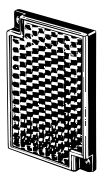

Material, reflective surface: acrylic
Rear surface: ABS

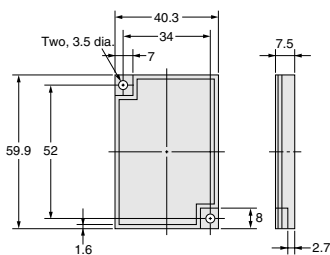

*E39-R1 only
Coating on reflective surface

E39-R9



Material, reflective surface: acrylic
Rear surface: ABS

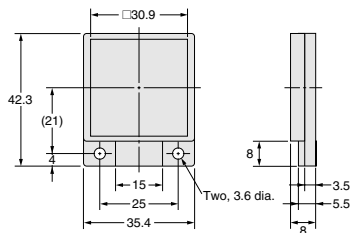

E39-R42

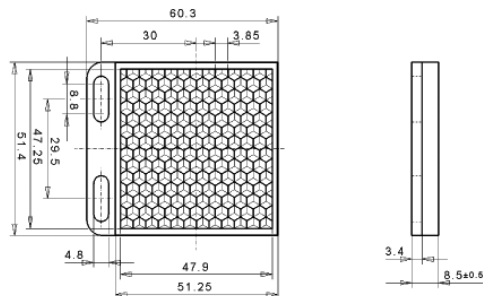

E39-R7

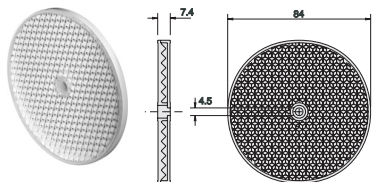

E39-R40

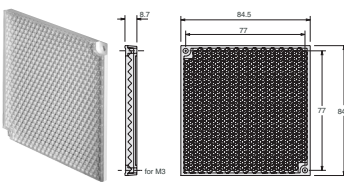

E39-R8

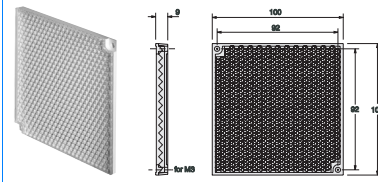

E39-R3

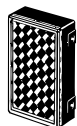

Material, reflective surface: acrylic
Rear surface: ABS

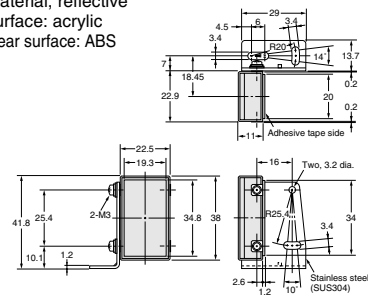

E39-R4



Material:
Reflective surface: acrylic
Rear surface: ABS

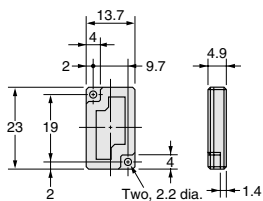

E39-R6

Material, reflective surface: acrylic
Rear surface: ABS

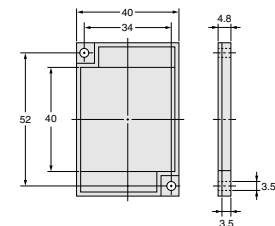

E39-R37



Material:
Mounting plate: stainless steel (SUS301)
Reflective surface: acrylic

Note: The reflective plate and mounting plate (1) come as a set.

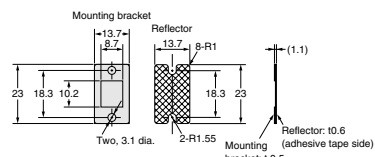

E39-R12/-R14

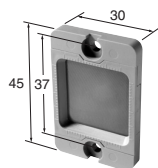

E39-R13

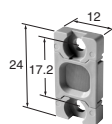

Accessories

Tape Reflectors

E39-RS3

E39-RS1

E39-RS2

E39-R

Reflectors

Type	Appearance	Model
Sheet (cuttable) Effective area: 195 × 22 mm		E39-RS4
Sheet (cuttable) Effective area: 108 × 46 mm		E39-RS5

Cat. No. E26E-EN2-03

In the interest of product improvement, specifications are subject to change without notice.

OMRON EUROPE B.V.

Wegalaan 67-69,
NL-2132 JD, Hoofddorp,
The Netherlands
Phone: +31 23 568 13 00
Fax: +31 23 568 13 88
www.eu.omron.com