

Floatless Level Controller (Ultra High-sensitivity Type) 61F-UHS/-HSL

Ideal for Detecting Ice, Pure Water, or Humidity

- Applicable for detecting ice, pure water steam, humidity, or other substances that conduct electricity poorly.
- Two types of model available: Ultra high-sensitivity and variable ultra high-sensitivity.



 Refer to Safety Precautions for Floatless Level Controllers.

Ordering Information

Type	Ultra high-sensitivity	Variable ultra high-sensitivity
	Model	Model
Ultra high-sensitivity	61F-UHS	61F-HSL
	61F-UHS	61F-HSL

Ultra High-sensitivity Models

Use these models for sensing objects such as ice, high-purity distilled water, moisture, or other objects with low electrical conductivity.

Specifications

Item	High-sensitivity 61F-UHS	Variable high-sensitivity 61F-HSL
Supply voltage	100, 200, or 220 VAC; 50/60 Hz	24, 100, 110, 200, or 220 VAC; 50/60 Hz
Operating voltage range	85% to 110% of rated voltage	
Interelectrode voltage	24 VAC	13 VDC max.
Interelectrode current	Approx. 1 mA AC max.	Approx. 1 mA DC max.
Power consumption	3.2 VA max.	
Interelectrode operate resistance	0 to approx. 1 M Ω (see note 1)	0 to approx. 5 M Ω (variable)
Interelectrode release resistance	Approx. 5 M to ∞ Ω	Operate resistance + 2.5 M Ω max.
Cable length	5 m (see note 2)	(see note 3)
Control output	0.3 A, 220 VAC (Inductive load: $\cos\phi = 0.4$) 1 A, 220 VAC (Resistive load)	2 A, 220 VAC (Inductive load: $\cos\phi = 0.4$) 5 A, 220 VAC (Resistive load)
Ambient temperature	Operating: -10°C to 55°C	
Ambient humidity	Operating: 45% to 85% RH	
Insulation resistance	100 M Ω max. (at 500 VDC)	
Dielectric strength	2,000 VAC, 50/60 Hz for 1 min	
Life expectancy	Electrical: 50,000 operations min. Mechanical: 5,000,000 operations min.	Electrical: 500,000 operations min. Mechanical: 5,000,000 operations min.
Weight	Approx. 210 g	

- Note:**
1. Use 61F-UHS for detecting water leakage with high specific resistance. Connect a sensor cable between terminals 1 and 7.
 2. Two Electrodes can be connected to the 61F-HSL. Use them for an alarm, not for creating a self-holding circuit.
 3. The length when using completely-insulated, 600-V, 3-conductor (0.75 mm²) cabtire cables. Usable cable lengths will become shorter as the cable diameter or number of conductors becomes larger. For more details, refer to *Safety Precautions for Floatless Level Controllers*.
 4. It is recommended that the cable length be kept as short as possible since the Electrode circuit current is at DC micro-current level. Moreover, the Electrodes will corrode rapidly if the current is allowed to constantly flow between the Electrodes. Be careful with the electrode polarity and grounding when wiring.

Internal Circuit Diagrams

61F-UHS

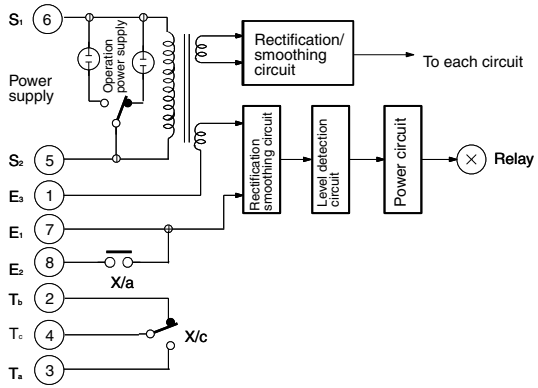

61F-HSL

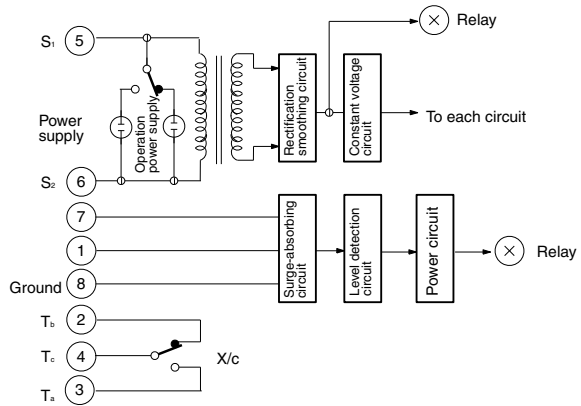

External Circuit Diagrams (Example)

61F-UHS

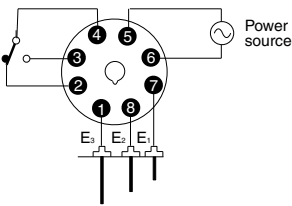

Socket: 8PFA1 (track mounted)/
PL08 (back connecting)

61F-HSL

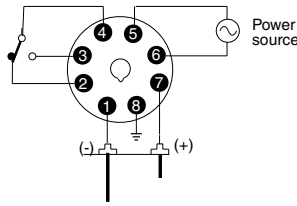

Socket: 8PFA (track mounted)/
PL08 (back connecting)

■ Connections

Automatic Water Supply and Drainage Control

Ultra High-sensitivity Type

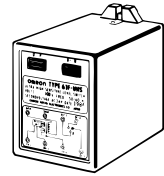

Dimensions:
Page 4

Automatic Water Supply Control	Automatic Drainage Control
<p>Connections</p> <p>Note: Be sure to ground the common Electrode E₃ (the longest Electrode).</p> <p>Connection Sockets 8PFA1 (Front-connecting) PL08 (Read-connecting)</p> <p>Connect terminal 2 to the the contactor coil terminal.</p>	<p>Connections</p> <p>Note: Be sure to ground the common Electrode E₃ (the longest Electrode).</p> <p>Connection Sockets 8PFA1 (Front-connecting) PL08 (Read-connecting)</p> <p>Connect terminal 3 to the the contactor coil terminal.</p>
<p>Principles of Operation</p> <ul style="list-style-type: none"> • When the water level reaches E₁, the pump stops and, when the water level reaches E₂ or below, the pump starts. 	<p>Principles of Operation</p> <ul style="list-style-type: none"> • When the water level reaches E₁, the pump starts and, when the water level reaches E₂ or below, the pump stops.

Dimensions

Note: All units are in millimeters unless otherwise indicated.

61F-UHS

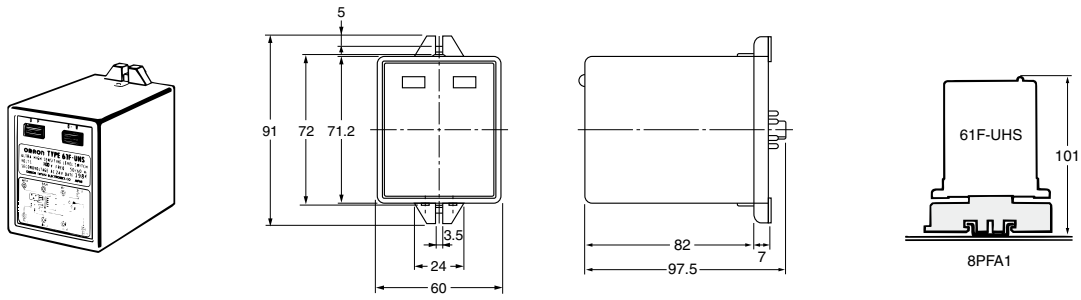

61F-HSL

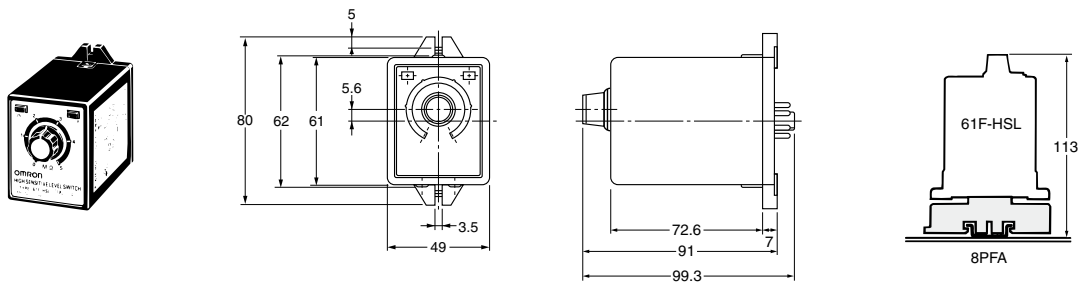

■ Safety Precautions

Refer to *Safety Precautions for All Level Controllers*.

■ Electrode Holders

PS-3S/-4S/-5S
PS-3SR/-4SR/-5SR
(see note)

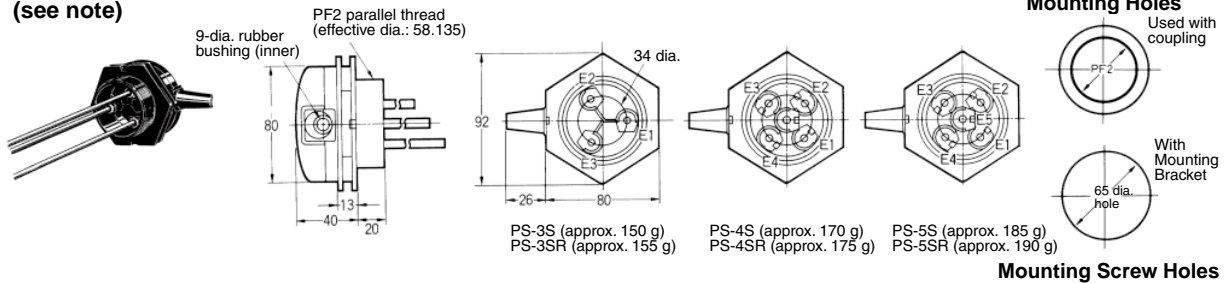

Note: The PS-3SR, PS-4SR, and PS-5SR have built-in resistor of 6.8 kΩ and used for the two-wire 61F models.

PS-31

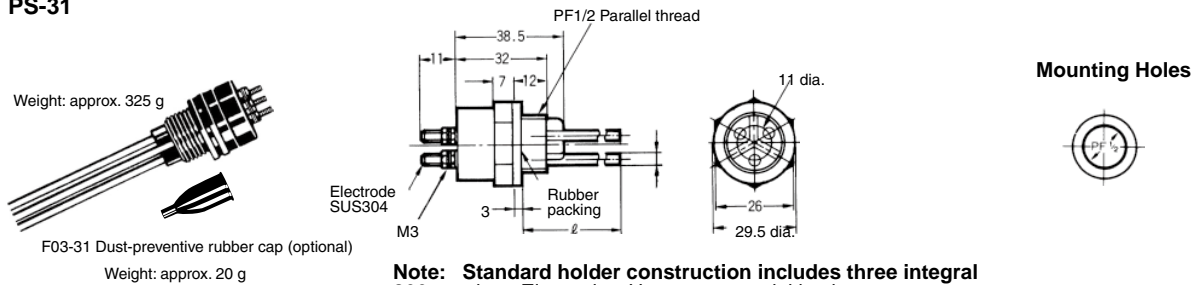

Note: Standard holder construction includes three integral 300-mm-long Electrodes. However, a model having 1,000-mm-long Electrodes is available on request.

BF-1

Weight: approx. 125 g

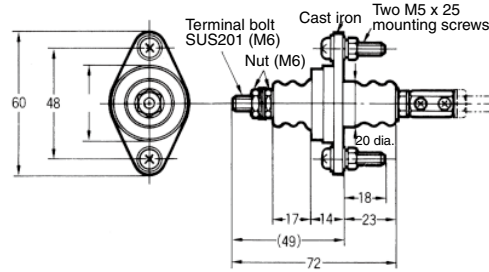

Mounting Holes

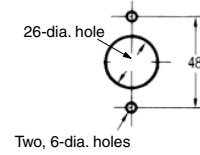

BF-3/-3R BF-5/-5R

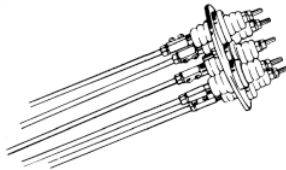

BF-3

Weight: approx. 420 g

BF-3R

Weight: approx. 425 g

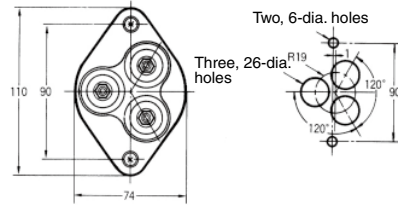

Mounting Holes

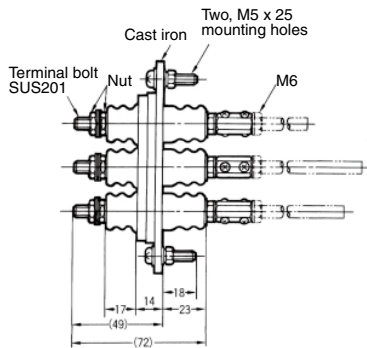
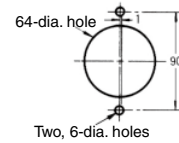

BF-5

Weight: approx. 710 g

BF-5R

Weight: approx. 715 g

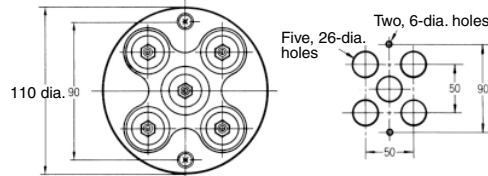

Mounting Holes

BS-1(S)

Weight: approx. 70 g

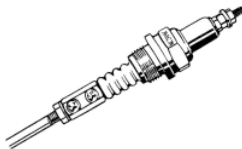

BS-1

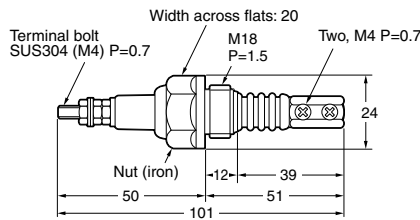

Mounting Holes



BS-1S BS-1S1 BS-1S2

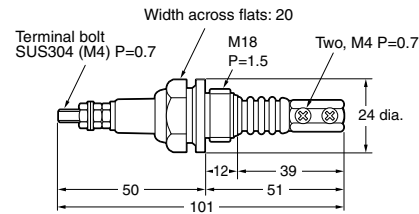

BS-1T

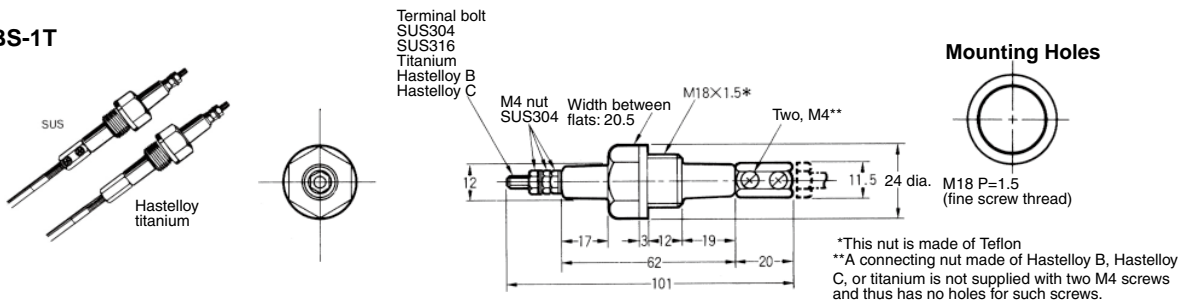

Material	SUS304	SUS316	Titanium	HAS B	HAS C
Weight	Approx. 55 g	Approx. 55 g	Approx. 45 g	Approx. 65 g	Approx. 60 g

PH-1

(Approx. 140 g with a 1-m cord)

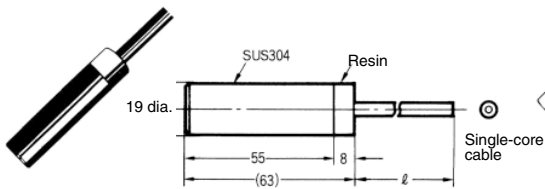

Cable OD: Vinyl 5.0 dia., Hypalon 6.5 dia.

PH-2

(Approx. 235 g with a 1-m cord)

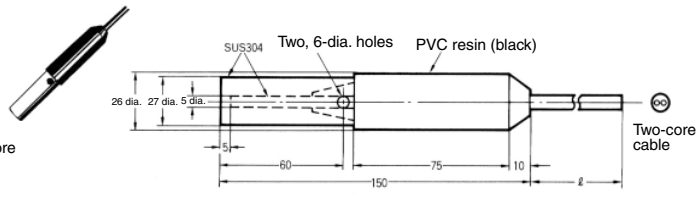

Cable OD: Vinyl, Hypalon 6.8 dia.

Note: Cable is supplied in lengths of 1, 5, 10, 15, 20, 30, 40, 50, 60, 70, 80, 90, or 100 meters.

■ Electrode Separators

F03-14 1P for one pole	F03-14 3P for three poles	F03-14 5P for five poles
<p>6.5 dia.</p> <p>28 dia.</p> <p>Weight: Approx. 15 g</p>	<p>Three, 7 dia.</p> <p>20</p> <p>41</p> <p>Weight: Approx. 30 g</p>	<p>Five, 7 dia.</p> <p>20</p> <p>46</p> <p>Weight: Approx. 30 g</p>

■ Electrode Bands

F03-05 3P, 4P, 5P

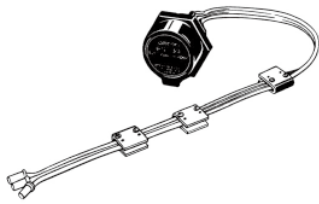

Black printing (1 mm wide)
Outer sheath: PVC
Core: SUS304, 0.3 dia. x 21 twisted

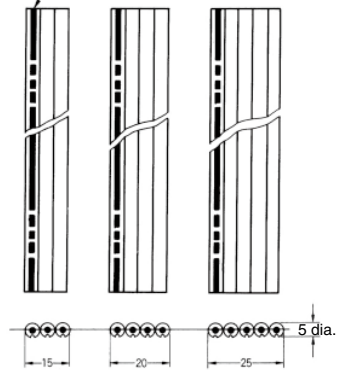

F03-06 Electrode Band Connecting Nut (SUS304)

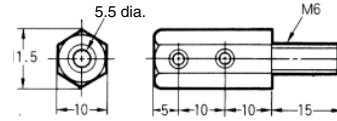

F03-07 U-shaped Electrode Band Weight (SUS304)

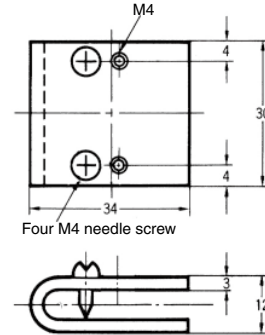

F03-08 End Cap (Neoprene Rubber)

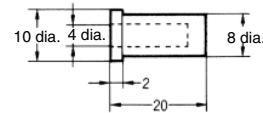

ALL DIMENSIONS SHOWN ARE IN MILLIMETERS.
To convert millimeters into inches, multiply by 0.03937. To convert grams into ounces, multiply by 0.03527.

In the interest of product improvement, specifications are subject to change without notice.

Safety Precautions for Floatless Level Controllers

⚠ WARNING

Do not touch the terminals while power is being supplied. Doing so may occasionally result in electric shock.



Do not attempt to disassemble, repair, or modify the product while the power is being supplied. Doing so may occasionally result in electric shock.



Precautions for Safe Use

Do not use the Controller in locations subject to explosive or combustible dust, combustible gas, flammable vapors, corrosive gas, excessive dust, salt water spray, or water drops.

Precautions for Correct Use

● Operating Environment

- Use and store the Controller within the rated ambient operating temperature, ambient operating humidity, and storage temperature ranges specified for individual models.
- Use the Controller according to the characteristics specified for individual models for vibration, shock, exposure to water, and exposure to oil.
- Install the Controller as far as possible from devices that generate strong high-frequency noise (such as high frequency welders or sewing machines).

● Tighten Terminal Screws to the Specified Torque

When fitting crimping terminals to terminal screws, use a tightening torque of between 0.45 and 0.6 N·m

● Use a Power Supply with Minimal Voltage Fluctuation

Avoid connection to a power supply with a voltage fluctuation greater than or equal to +10% or -15%.

● Consider the Ambient Temperature

Do not install the Controller where it may be exposed to a temperature of 55°C or higher or a humidity of 85% or higher. In particular, install the Controller away from heat-generating equipment incorporating coils or windings. Do not use the Controller outdoors or in locations subject to high humidity, corrosive gases, or direct sunlight.

● Avoid Vibration and Shocks

Do not subject the Controller to vibration or shocks which can cause chattering problems. Do not install the Controller near contactors that generate severe shocks while the contactors are in operation.

● Do Not Test with a Megohmmeter

During insulation resistance measurements, never apply the megohmmeter across the Electrode terminals.

● Use Self-holding Electrodes

- Use Self-holding (E2) Electrodes when contactor open/close control is carried out. If E1 Electrodes are used, ripples on the liquid surface can cause incorrect contactor operation and damage to the contacts.
- Be sure to turn OFF the power supply before replacing the plug-in models.

● Short Wiring in Electrode Circuit

- Keep the wires connecting the Controller to Electrode Holders as short as possible. If long leads are used, the floating capacity of the leads, and abnormal surges or noise in the Electrode circuit can cause malfunctions.
- The thicker the cables, the shorter the permitted wiring length. The length of the cable connecting the Controller and Electrode is specified in the Controller datasheet as a guideline assuming that a 600-V VCT 0.75-mm², 3-core cable is used. Test results indicate that the actual wiring length using VCT 3.5-mm², 3-core cable laid over the ground is 50% of the specified length for

general-purpose applications and 80% of the specified length for long-distance applications. When selecting cable specifications, remember that the wiring length is further decreased for underground cables and larger diameter cables because of the increased floating capacity with the ground.

● Keep Power Cables Separate from the Electrode Circuit

Do not pass the leads for the Electrode circuit through the same duct, or near to, high-tension cables or power cables. This can cause noise which leads to malfunctions.

● Ground Correctly

Ground the common Electrode terminal to reduce the effects of noise.

● Use a Surge Suppressor

Connect a 61F-03B(-04B) Surge Suppressor with the Controller's Electrode terminals to protect the circuit from surges. This is particularly important in lightning-prone areas. To further improve protection, install a commercial surge suppressor in the power supply to eliminate surges in the power system. (Refer to 61F-03B/-04B.)

● Consider the Response Times

The Controller requires a response time not exceeding 80 ms for operation or 160 ms for reset. Take these response times into account in cases where precise sequence control is required.

● Consider the Liquids to Be Controlled

- The Controller cannot be used for any liquid that has almost no conductivity such as sewage containing oil.
- The Controller cannot be used for any flammable liquid such as gasoline, kerosene, or heavy oil.

● Do Not Share Electrodes

Do not connect a single Electrode to more than one Controller. If the phases of the 8-VAC Electrode-circuit power supplies are opposite to each other, as shown in Fig. 1, an internal close circuit (return circuit) is created (indicated by the arrows). The Controller may malfunction regardless of the liquid level when the Controller power is turned ON. This problem can be overcome by matching the power supply phases, as shown in Fig. 2, but in this configuration the internal impedance of the Controller calculated from the Electrode will be approximately half as large as the internal impedance of a single Controller. Maintain sufficient clearance between Electrodes connected to separate Controllers so that they do not interfere with each other. Common leads, however, can be connected to the ground Electrode.

Fig. 1 Internal Closed Circuit

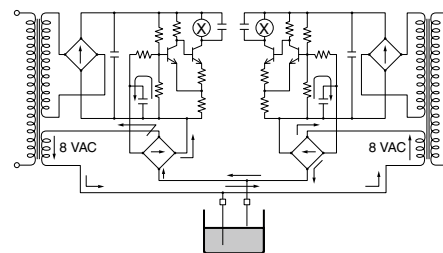
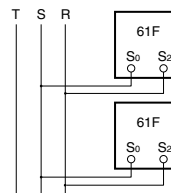

Fig. 2 Match Phases



ALL DIMENSIONS SHOWN ARE IN MILLIMETERS.
To convert millimeters into inches, multiply by 0.03937. To convert grams into ounces, multiply by 0.03527.

In the interest of product improvement, specifications are subject to change without notice.

Safety Precautions for All Level Controllers

Refer to the *Safety Precautions* section for each product for specific precautions applicable to that product.

WARNING

Do not touch the terminals while power is being supplied. Doing so may possibly result in electric shock.

Do not attempt to disassemble, repair, or modify the product while power is being supplied. Doing so may occasionally result in electric shock.

■ Precautions for Safe Use

In order to ensure safe operation, be sure to observe the following points.

1. Use a power supply voltage within the specified range.
2. Do not use the Controller in locations subject to flammable gases or objects.
3. Insert the Socket until it securely clicks into place.
4. Do not short the load connected to the output terminals.
5. Do not connect the power supply in reverse.
6. Do not use the Controller in locations subject to explosive or combustible dust, combustible gas, flammable vapors, corrosive gas, excessive dust, salt water spray, or water drops.

■ Precautions for Correct Use

For details, refer to *Technical Guide for Level Controllers*.

In the interest of product improvement, specifications are subject to change without notice.

Read and Understand This Catalog

Please read and understand this catalog before purchasing the products. Please consult your OMRON representative if you have any questions or comments.

Warranty and Limitations of Liability

WARRANTY

OMRON's exclusive warranty is that the products are free from defects in materials and workmanship for a period of one year (or other period if specified) from date of sale by OMRON.

OMRON MAKES NO WARRANTY OR REPRESENTATION, EXPRESS OR IMPLIED, REGARDING NON-INFRINGEMENT, MERCHANTABILITY, OR FITNESS FOR PARTICULAR PURPOSE OF THE PRODUCTS. ANY BUYER OR USER ACKNOWLEDGES THAT THE BUYER OR USER ALONE HAS DETERMINED THAT THE PRODUCTS WILL SUITABLY MEET THE REQUIREMENTS OF THEIR INTENDED USE. OMRON DISCLAIMS ALL OTHER WARRANTIES, EXPRESS OR IMPLIED.

LIMITATIONS OF LIABILITY

OMRON SHALL NOT BE RESPONSIBLE FOR SPECIAL, INDIRECT, OR CONSEQUENTIAL DAMAGES, LOSS OF PROFITS, OR COMMERCIAL LOSS IN ANY WAY CONNECTED WITH THE PRODUCTS, WHETHER SUCH CLAIM IS BASED ON CONTRACT, WARRANTY, NEGLIGENCE, OR STRICT LIABILITY.

In no event shall responsibility of OMRON for any act exceed the individual price of the product on which liability is asserted.

IN NO EVENT SHALL OMRON BE RESPONSIBLE FOR WARRANTY, REPAIR, OR OTHER CLAIMS REGARDING THE PRODUCTS UNLESS OMRON'S ANALYSIS CONFIRMS THAT THE PRODUCTS WERE PROPERLY HANDLED, STORED, INSTALLED, AND MAINTAINED AND NOT SUBJECT TO CONTAMINATION, ABUSE, MISUSE, OR INAPPROPRIATE MODIFICATION OR REPAIR.

Application Considerations

SUITABILITY FOR USE

OMRON shall not be responsible for conformity with any standards, codes, or regulations that apply to the combination of products in the customer's application or use of the product.

At the customer's request, OMRON will provide applicable third party certification documents identifying ratings and limitations of use that apply to the products. This information by itself is not sufficient for a complete determination of the suitability of the products in combination with the end product, machine, system, or other application or use.

The following are some examples of applications for which particular attention must be given. This is not intended to be an exhaustive list of all possible uses of the products, nor is it intended to imply that the uses listed may be suitable for the products:

- Outdoor use, uses involving potential chemical contamination or electrical interference, or conditions or uses not described in this catalog.
- Nuclear energy control systems, combustion systems, railroad systems, aviation systems, medical equipment, amusement machines, vehicles, safety equipment, and installations subject to separate industry or government regulations.
- Systems, machines, and equipment that could present a risk to life or property.

Please know and observe all prohibitions of use applicable to the products.

NEVER USE THE PRODUCTS FOR AN APPLICATION INVOLVING SERIOUS RISK TO LIFE OR PROPERTY WITHOUT ENSURING THAT THE SYSTEM AS A WHOLE HAS BEEN DESIGNED TO ADDRESS THE RISKS, AND THAT THE OMRON PRODUCT IS PROPERLY RATED AND INSTALLED FOR THE INTENDED USE WITHIN THE OVERALL EQUIPMENT OR SYSTEM.

Disclaimers

CHANGE IN SPECIFICATIONS

Product specifications and accessories may be changed at any time based on improvements and other reasons.

It is our practice to change model numbers when published ratings or features are changed, or when significant construction changes are made. However, some specifications of the product may be changed without any notice. When in doubt, special model numbers may be assigned to fix or establish key specifications for your application on your request. Please consult with your OMRON representative at any time to confirm actual specifications of purchased product.

DIMENSIONS AND WEIGHTS

Dimensions and weights are nominal and are not to be used for manufacturing purposes, even when tolerances are shown.

ERRORS AND OMISSIONS

The information in this catalog has been carefully checked and is believed to be accurate; however, no responsibility is assumed for clerical, typographical, or proofreading errors, or omissions.

PERFORMANCE DATA

Performance data given in this catalog is provided as a guide for the user in determining suitability and does not constitute a warranty. It may represent the result of OMRON's test conditions, and the users must correlate it to actual application requirements. Actual performance is subject to the OMRON Warranty and Limitations of Liability.

PROGRAMMABLE PRODUCTS

OMRON shall not be responsible for the user's programming of a programmable product, or any consequence thereof.

COPYRIGHT AND COPY PERMISSION

This catalog shall not be copied for sales or promotions without permission.

This catalog is protected by copyright and is intended solely for use in conjunction with the product. Please notify us before copying or reproducing this catalog in any manner, for any other purpose. If copying or transmitting this catalog to another, please copy or transmit it in its entirety.