

Technical Data Sheet

1.8mm Round Subminiature Silicon PIN Photodiode

PD42-21C/TR8

Features

- Fast response time
- High photo sensitivity
- Small junction capacitance
- Package in 12mm tape on 7" diameter reel
- Pb free
- The product itself will remain within RoHS compliant version.



Descriptions

- PD42-21C/TR8 is a high speed and high sensitive PIN photodiode in miniature spherical top view lens SMD package and it is molded in a black plastic .The device is spectrally matched with the infrared emitting diode.

Applications

- High speed photo detector
- Copier
- Game machine
- Infrared applied system

Device Selection Guide

LED Part No.	Chip	Lens Color
	Material	
PD	Silicon	Water clear

Package Dimensions

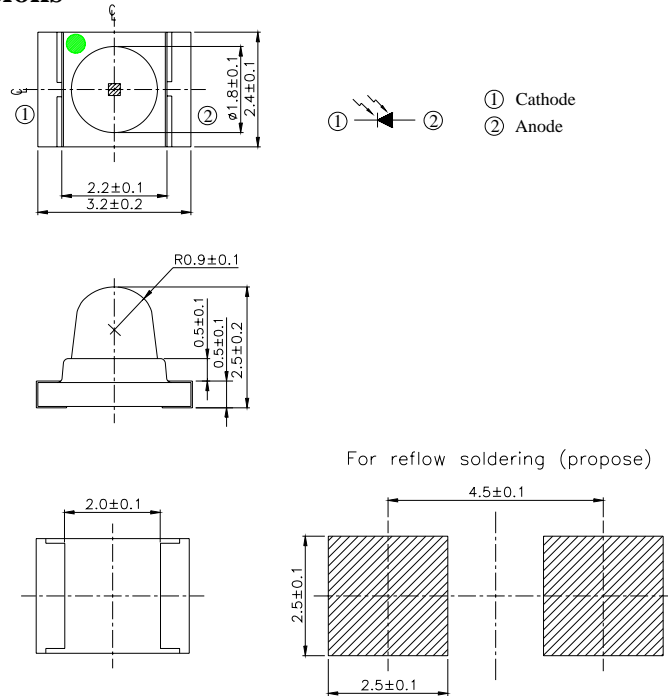

- Notes:** 1.All dimensions are in millimeters
2.Tolerances unless dimensions ± 0.1 mm

Absolute Maximum Ratings (Ta=25°C)

Parameter	Symbol	Rating	Units
Reverse Voltage	V _R	32	V
Operating Temperature	T _{opr}	-25 ~ +85	°C
Storage Temperature	T _{stg}	-40 ~ +100	°C
Soldering Temperature	T _{sol}	260	°C
Power Dissipation at(or below) 25°C Free Air Temperature	P _c	150	mW

Notes: *1:Soldering time ≤ 5 seconds.

Electro-Optical Characteristics (Ta=25°C)

Parameter	Symbol	Condition	Min	Typ	Max	Unit
Rang Of Spectral Bandwidth	$\lambda_{0.5}$	---	400	---	1100	nm
Wavelength Of Peak Sensitivity	λ_P	---	---	940	---	nm
Open-Circuit Voltage	V_{OC}	$E_e=5mW/cm^2$ $\lambda_P=940nm$	---	0.42	---	V
Short-Circuit Current	I_{SC}	$E_e=1mW/cm^2$ $\lambda_P=875nm$	2.0	5.0	12	μA
Reverse Light Current	I_L	$E_e=1mW/cm^2$ $\lambda_P=875nm$ $V_R=5V$	2.0	5.0	12	μA
Dark Current	I_D	$E_e=0mW/cm^2$ $V_R=10V$	---	---	10	nA
Reverse Breakdown Voltage	B_{VR}	$E_e=0mW/cm^2$ $I_R=100\mu A$	32	170	---	V
Total Capacitance	C_t	$E_e=0mW/cm^2$ $f=1MHz$ $V_R=5V$	---	5	---	pF
Rise Time	t_r	$V_R=10V$ $R_L=1000\Omega$	---	6	---	nS
Fall Time	t_f		---	6	---	

Typical Electro-Optical Characteristics Curves

Fig.1 Power Dissipation vs. Ambient Temperature

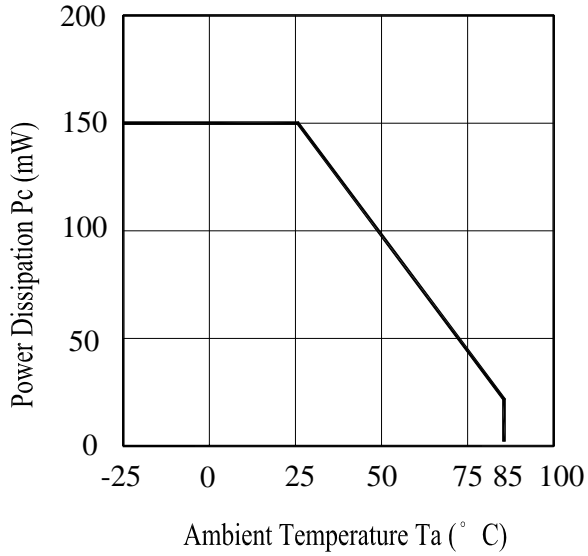

Fig.2 Spectral Sensitivity

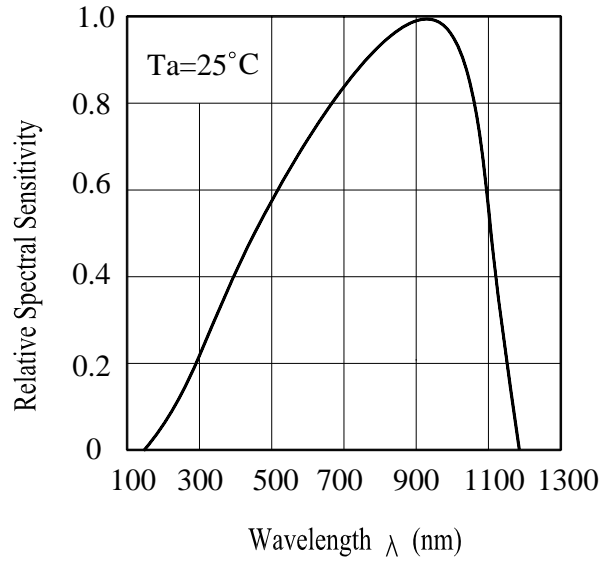

Fig.3 Dark Current vs. Ambient Temperature

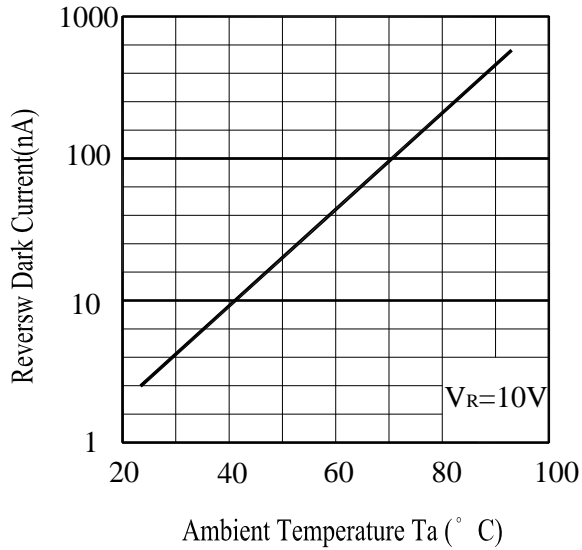
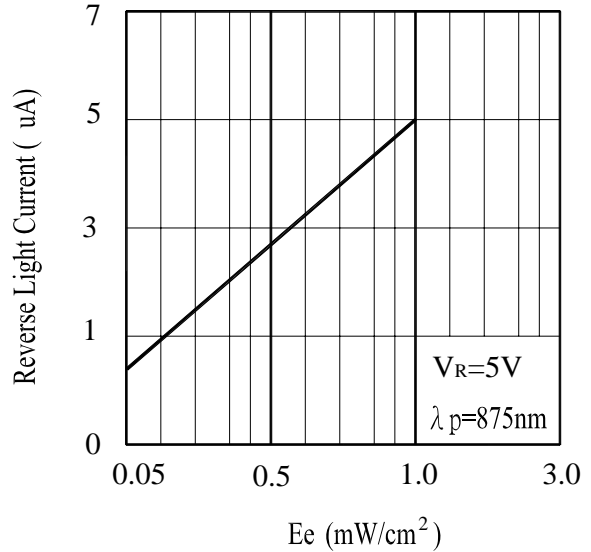

Fig.4 Reverse Light Current vs. E_e



Typical Electro-Optical Characteristics Curves

Fig.5 Terminal Capacitance vs. Reverse Voltage

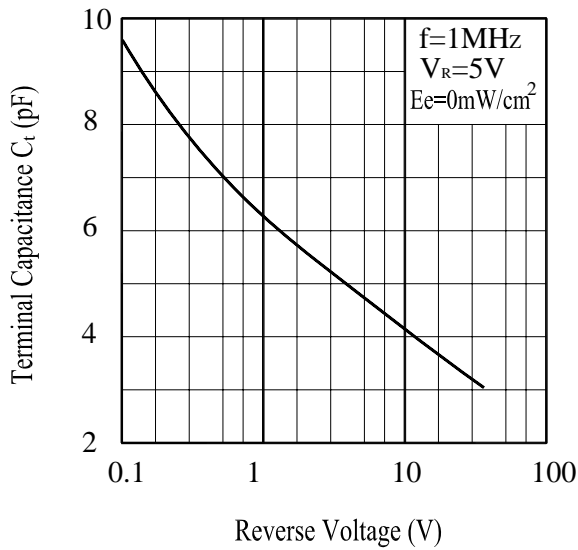
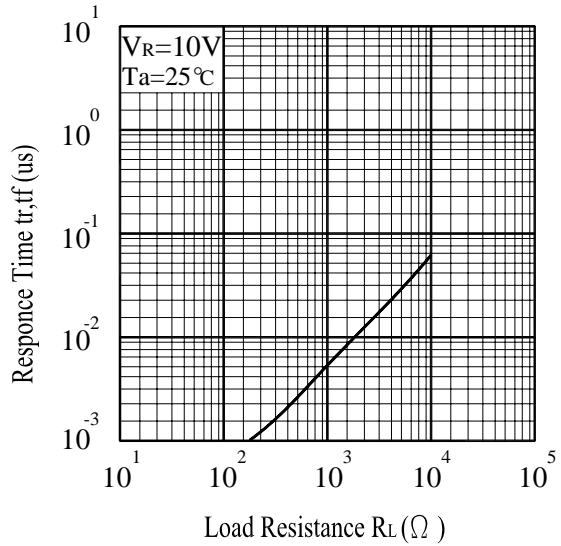

Fig.6 Response Time vs. Load Resistance



Precautions For Use

1. Over-current-proof

Customer must apply resistors for protection , otherwise slight voltage shift will cause big current change (Burn out will happen).

2. Storage

2.1 Do not open moisture proof bag before the products are ready to use.

2.2 Before opening the package, the LEDs should be kept at 30°C or less and 90%RH or less.

2.3 The LEDs should be used within a year.

2.4 After opening the package, the LEDs should be kept at 30°C or less and 70%RH or less.

2.5 The LEDs should be used within 168 hours (7 days) after opening the package.

2.6 If the moisture absorbent material (silica gel) has faded away or the LEDs have exceeded the storage time, baking treatment should be performed using the following conditions.

Baking treatment : $60\pm 5^{\circ}\text{C}$ for 24 hours.

3. Soldering Condition

3.1 Pb-free solder temperature profile

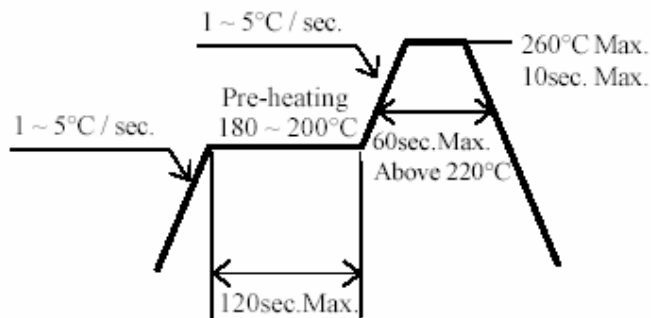

3.2 Reflow soldering should not be done more than two times.

3.3 When soldering, do not put stress on the LEDs during heating.

3.4 After soldering, do not warp the circuit board.

4.Soldering Iron

Each terminal is to go to the tip of soldering iron temperature less than 280°C for 3 seconds within once in less than the soldering iron capacity 25W. Leave two seconds and more intervals, and do soldering of each terminal. Be careful because the damage of the product is often started at the time of the hand solder.

5.Repairing

Repair should not be done after the LEDs have been soldered. When repairing is unavoidable, a double-head soldering iron should be used (as below figure). It should be confirmed beforehand whether the characteristics of the LEDs will or will not be damaged by repairing.

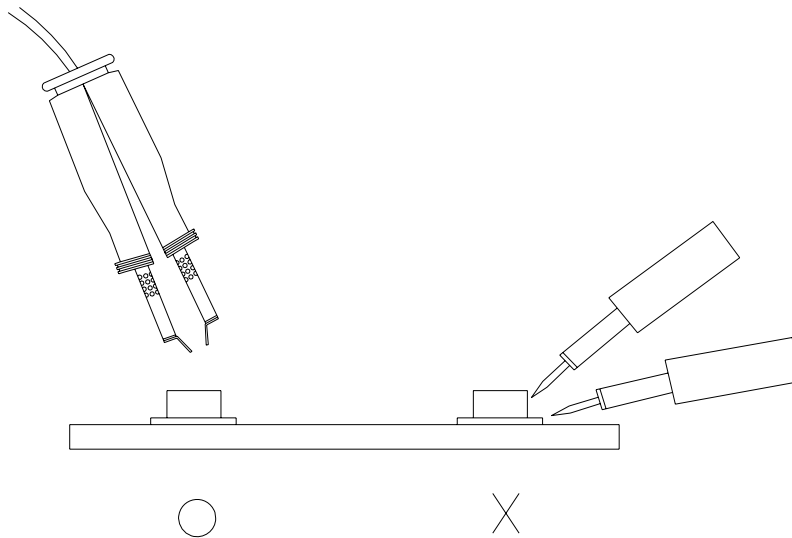

Reliability Test Item And Condition

The reliability of products shall be satisfied with items listed below.

Confidence level : 90%

LTPD : 10%

NO.	Item	Test Conditions	Test Hours/ Cycles	Sample Sizes	Failure Judgement Criteria	Ac/Re
1	REFLOW Soldering	TEMP. : 260°C±5°C 5secs	6Mins	22pcs	$I_L \leq L \times 0.8$ L : Lower Specification Limit	0/1
2	Temperature Cycle	H : +100°C 15mins \updownarrow 5mins L : -40°C 15mins	50Cycles	22pcs		0/1
3	Thermal Shock	H : +100°C 5mins \updownarrow 10secs L : -10°C 5mins	50Cycles	22pcs		0/1
4	High Temperature Storage	TEMP. : +100°C	1000hrs	22pcs		0/1
5	Low Temperature Storage	TEMP. : -40°C	1000hrs	22pcs		0/1
6	DC Operating Life	$V_R=5V$	1000hrs	22pcs		0/1
7	High Temperature/ High Humidity	85°C / 85% R.H	1000hrs	22pcs		0/1

Package Dimensions

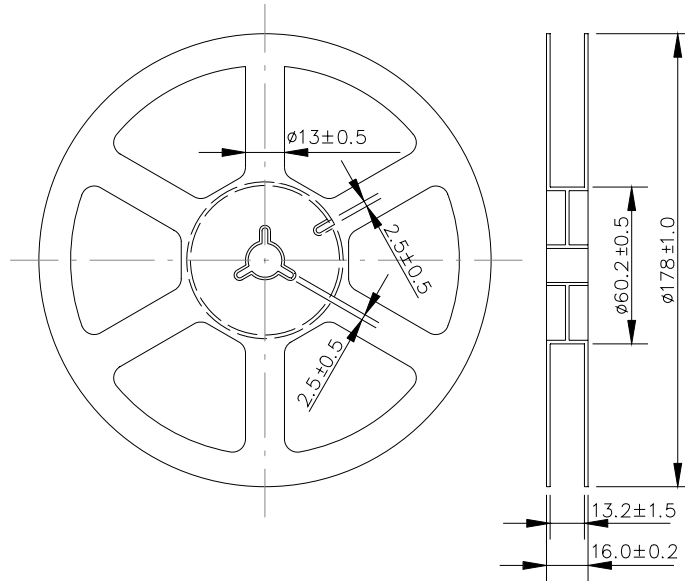

Taping Dimensions

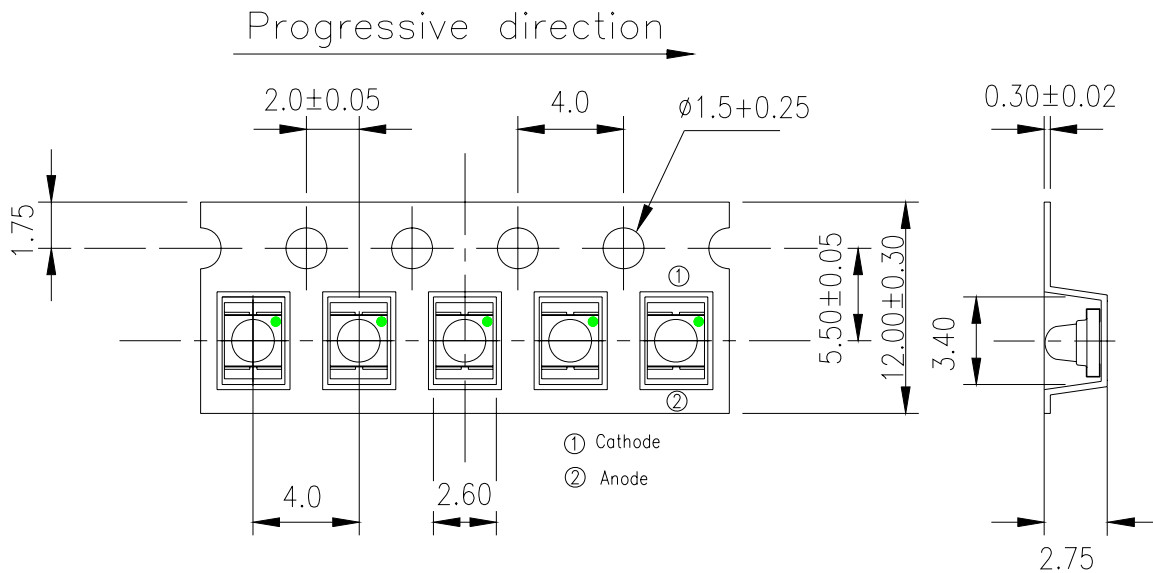

Unit:mm

Packing Quantity Specification

- 1.1000Pcs/1Volume , 1Volume/1Bag
- 2.10Boxes/1Carton

Label Form Specification

EVERLIGHT	
CPN:	
P/N:	
	RoHS
QTY:	PD42-21C/TR8
	CAT:
LOT NO:	HUE:
	REF:
MADE IN TAIWAN	

CPN: Customer's Production Number

P/N : Production Number

QTY: Packing Quantity

CAT: Ranks

HUE: Peak Wavelength

REF: Reference

LOT No: Lot Number

MADE IN TAIWAN: Production Place

Notes

1. Above specification may be changed without notice. EVERLIGHT will reserve authority on material change for above specification.
2. When using this product, please observe the absolute maximum ratings and the instructions for using outlined in these specification sheets. EVERLIGHT assumes no responsibility for any damage resulting from use of the product which does not comply with the absolute maximum ratings and the instructions included in these specification sheets.
3. These specification sheets include materials protected under copyright of EVERLIGHT corporation. Please don't reproduce or cause anyone to reproduce them without EVERLIGHT's consent.

EVERLIGHT ELECTRONICS CO., LTD.
Office: No 25, Lane 76, Sec 3, Chung Yang Rd,
Tucheng, Taipei 236, Taiwan, R.O.C

Tel: 886-2-2267-2000, 2267-9936
Fax: 886-2267-6244, 2267-6189, 2267-6306
<http://www.everlight.com>