

# TRANSDUCERS

Solutions For Voltage, Current, Power & Frequency

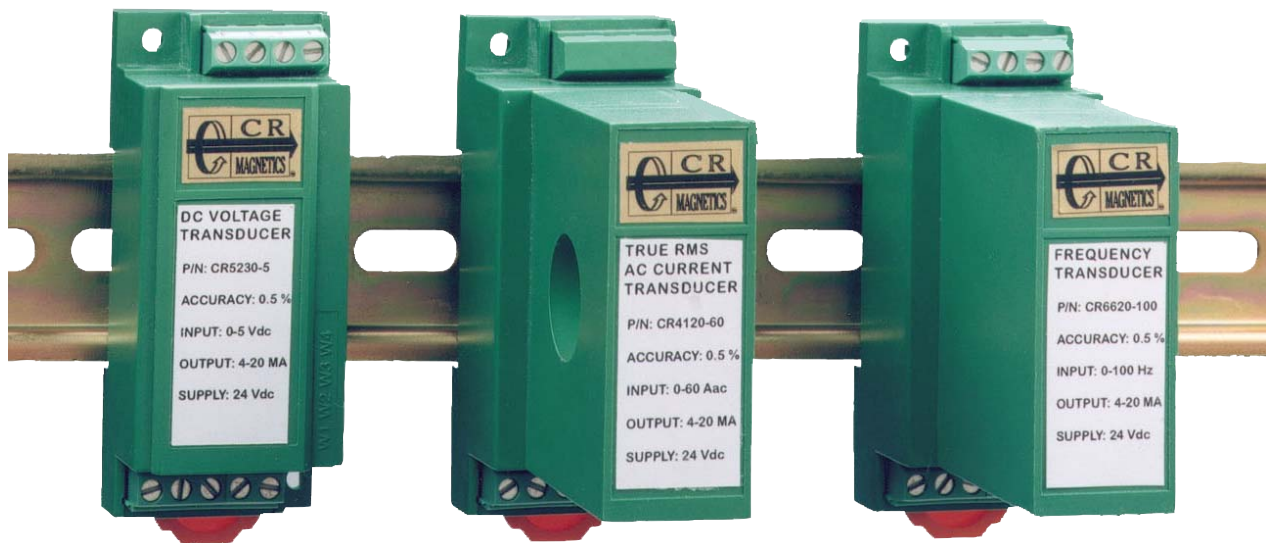

An Advanced Line Of Precision Transducers:

- True RMS
- DC Sensing
- Loop Powered
- Self Powered
- Active & Reactive Power

CURRENT SOLUTIONS





[www.crmagnetics.com](http://www.crmagnetics.com)

sales@crmagnetics.com

Ph: 636-343-8518

Fx: 636-343-5119

544 Axminister Dr.

Fenton, MO 63026

USA

## Specialists in Electrical Current and Power Monitoring Products

### CURRENT

True RMS, Average RMS, DIN Rail, Panel Mount, Rugged Environment, Multi-phase, Mono-phase, AC & DC

### VOLTAGE

True RMS, Average RMS, DIN Rail, Panel Mount, Rugged Environment, Multi-phase, Mono-phase, AC & DC

### POWER

Active, Reactive, 1, 2, or 3 Elements, DIN Rail, Panel Mount

### FREQUENCY

Sine Wave, Square Wave, Zero-Cross, DIN Rail, Panel Mount

© 2003 CR Magnetics, Inc. — All rights reserved







The information in this catalog has been carefully checked and is believed to be accurate; however, no responsibility is assumed for any inaccuracies.

CR Magnetics, Inc. 544 Axminister Dr. Fenton MO USA 63026 V: 636.343.8518 F: 636.343.5119



















Web: <http://www.crmagnetics.com>

E-mail: sales@crmagnetics.com

# TRANSDUCCERS

CURRENT										
AC								AC/DC	DC	
True RMS			Average RMS						RMS	
24 Vdc			Loop Powered			Self Powered	120 Vac Powered	24 Vdc		
<b>Power Source</b>	24 Vdc			Loop Powered			Self Powered	120 Vac Powered	24 Vdc	
<b>Elements</b>	1	2	3	1	2	1	1	1	1	
<b>Input Range</b>	0.5 - 150 Aac	0.5 - 15 Aac	0.5 - 15 Aac	0.5 - 50 Aac	0.5 - 50 Aac	5 - 400 Aac	5 - 200 Aac	5 - 600 Aac	20 - 300 Aac/dc ±DC - 4 KHZ	0 - 300 Adc
<b>Mounting</b>	DIN/PANEL					PANEL			DIN/PANEL	
<b>Output</b>	0 - 5 Vdc 4-20 mAdc			4-20 mAdc			0-5 Vdc 0-10 Vdc	4-20 mAdc	±5 Vac/dc	0-5 Vdc 4-20 mAdc
<b>Part Number</b>	CR4110 CR4120	CR4150 CR4160	CR4170 CR4180	CR4220	CR4260	CR4320	CR4310 CR4311	CR4340	CR5410	CR5210 CR5220
<b>Agency Approval</b>										
<b>Page</b>	6	6	6	14	14	10	8	12	16	18

# TRANSDUCCERS











VOLTAGE					POWER				FREQUENCY
AC			DC		AC				
True RMS		Average RMS			RMS	Active/Reactive			Sine Wave Square Wave Zero-Cross
24 Vdc		Loop Powered		24 Vdc		12 Vdc			24 Vdc
1	3 Δ 3 Y	1	2	3 Δ 3 Y	1	1	3 Δ	3 Y	1
50-500 Vac				120-480 Vac	.05-200 Vdc	5-50 Aac 150-500 Vac			100-5000K Hz
DIN/PANEL				PANEL	DIN/PANEL				
0-5Vdc 4-20 mAdc		4-20 mAdc			0 - 5 Vdc 4-20 mAdc				
CR4510 CR4520	CR4550 CR4560 CR4570 CR4580	CR4620	CR4640	CR4730 CR4731	CR5310 CR5320	CR6210 CR6211 CR6220 CR6221	CR6230 CR6231 CR6240 CR6241	CR6250 CR6251 CR6260 CR6261	CR6610 CR6611 CR6612 CR6620 CR6621 CR6622
									
									
20	20	24	24	22	26	28	28	28	32

## RELAYS and INDICATORS

	Relays			Indicators		
						
<b>Part Number</b>	<b>CR4395</b>	<b>CR7310</b>	<b>CR9321</b>	<b>CR45</b>	<b>Model 18 &amp; 19</b>	<b>CR2550</b>
<b>Description</b>	Current Relay	Ground Fault Sensor	Current Switch	Current Indicator	Current Indicator	Current Indicator
<b>Frequency</b>	60/400 Hz	60/400 Hz	50/400Hz	50/60 Hz	50/60 Hz	50/400 Hz
<b>Input Range</b>	.01 to 100 Aac	.01 to 100 Aac	0.350 Aac	2 to 100 Aac	2 to 100 Aac	2 to 100 Aac
<b>Output</b>	Relay Transistor Triac	Relay Transistor Triac	Solid State	Visual	Visual	Visual
<b>Accuracy</b>	—	—	—	—	—	—
<b>Dimensions (H)x(W)x(D)</b>	2.13 x 3.50 x 2.5 (54.1x88.9x63.5)	2.13 x 3.50 x 2.5 (54.1x88.9x63.5)	1.50x1.0x.75 (38.1x25.4x19.1)	1.04x.95x.46 (26.4x24.1x11.7)	See Catalog	See Catalog
<b>Power Source</b>	120 Vac 240 Vac 24 Vdc	120 Vac 240 Vac 24 Vdc	Self Powered	Self Powered	Self Powered	Self Powered
<b>Agency Approval</b>			—	—	—	—

Contact factory or see Internet site for additional information on our Current Sensing Relays and Visual Current Indicators.

## CURRENT TRANSFORMERS

Current Transformers						
						
<b>17,18, 19</b>		<b>CR8750</b>	<b>CR8400</b>		<b>CR8300</b>	
Wire Lead	Commercial ANSI Class	Horizontal Mount	Wire Lead	Split Core	Vertical Mount	Medium Voltage
50-400 Hz	50-400 Hz	50-400 Hz	—	50-400 Hz	50-400 Hz	50-400 Hz
Up to 60 Aac	Up to 4,000 Aac	Up to 60 Aac	—	Up to 10,000 Aac	Up to 100 Aac	Up to 3,000 Aac
—	5.0, 1.0 0.2, 0.1 AAC	—	—	5.0 Aac & High Ratios	—	5.0 Aac
—	Up to 0.3%	—	—	Up to 0.3%	—	Up to 0.3%
.29 & .55 (7.4 & 14.0)	See Catalog	.250 (6.4)	.232 to .610 (5.8 to 15.5)	See Catalog	.272 to .772 (6.9 to 19.6)	See Catalog
—	—	—	—	—	—	—
		—	—		—	

**Contact factory or see Internet site for additional information on our Current Transformers.**



# True RMS AC Current Transducer

DIN RAIL / PANEL MOUNT, TRUE RMS

The **CR4100** Series true RMS Current Transducers and Transmitters are designed for applications where AC current waveforms are not purely sinusoidal. More precise and accurate than other transducers, these devices are ideal in chopped wave and phase fired control systems.



**CR4110 CR4120**  
One Element - .79" Window  
0.5 to 150 Aac Range



**CR4150 CR4160**  
Two Element - .26" Window  
0.5 to 30 Aac Range



**CR4170 CR4180**  
Three Element .26" window  
0.5 to 30 Aac Range

## Regulatory Agencies

- Approved to UL3111-1, First Edition, Amendment 2
- Approved to CAN/CSA-C22.2, No. 1010.1-92
- Meets requirement of IEC 61010-1 and BS EN 61010-1

## Applications

- Phase fired controlled heaters
- Quickly varying motor loads
- Chopped wave form drivers
- Harmonic currents

## Features

- 35mm DIN Rail or Panel Mount
- Available with 0 - 5 Vdc or 4 - 20 mA DC outputs
- 24 Vdc powered
- Use with external current transformers
- Highest precision available
- Connection diagram printed on case

## Internet Resources <http://www.crmagnetics.com/>

- Pricing: pricing/4100.html
- Application Sheets: pdf/ancr4310.pdf, pdf/ancr4310-2.pdf, pdf/ancr4320.pdf

See page 34 for typical applications

## Part Numbers

- CR4110** -  Single element with 0 - 5 Vdc output
- CR4120** -  Single element with 4 - 20 mA DC output
- CR4150** -  Two element with 0 - 5 Vdc output \*
- CR4160** -  Two element with 4 to 20 mA DC output \*
- CR4170** -  Three element with 0 - 5 Vdc output \*
- CR4180** -  Three element with 4 - 20 mA DC output \*

\* Two and three element transducers are available only in ranges of 0.5 to 30 Aac

Add suffix for input range

- |                        |                        |
|------------------------|------------------------|
| <b>.5</b> - 0-.5 Aac * | <b>40</b> - 0-40 Aac   |
| <b>5</b> - 0- 5 Aac *  | <b>50</b> - 0-50 Aac   |
| <b>10</b> - 0-10 Aac * | <b>75</b> - 0-75 Aac   |
| <b>15</b> - 0-15 Aac * | <b>100</b> - 0-100 Aac |
| <b>20</b> - 0-20 Aac * | <b>150</b> - 0-150 Aac |
| <b>25</b> - 0-25 Aac * |                        |
| <b>30</b> - 0-30 Aac * |                        |

Other Ranges Available

# True RMS AC Current Transducer

## Specifications

Basic Accuracy:.....	0.5%	Frequency Range:.....	20 Hz - 5 KHz
Calibration:.....	True RMS Sensing	MTBF:.....	Greater than 100 K hours
Thermal Drift:.....	500 PPM/°C	Cleaning:.....	Water-dampened cloth
Operating Temperature:.....	0°C to +60°C	Supply Voltage:.....	24 Vdc ±10%
Installation Category:.....	CAT II	Output Load:.....	4-20 mA dc - 0 to 300 Ω
Pollution Degree:.....	2		0-5 Vdc - 2K Ω or Greater
Insulation Voltage:.....	2500 Vdc	Response Time:.....	250 ms max. 0-90% FS
Altitude:.....	2000 meter max.	Relative Humidity:.....	80% for temperatures up to 31°C and decreasing linearly to 50% at 40°C

## Connection Drawings

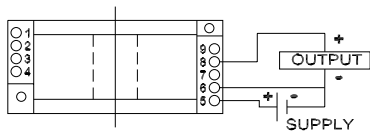

**CR4110** One Element 0 - 5 Vdc Output

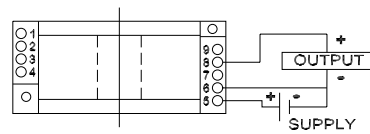

**CR4120** One Element 4 - 20 mA DC Output

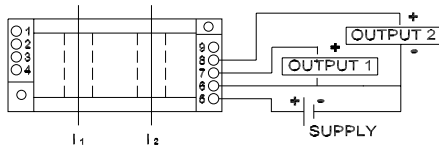

**CR4150** Two Element 0 - 5 Vdc Output

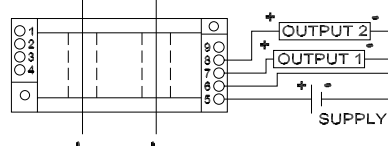

**CR4160** Two Element 4 - 20 mA DC Output

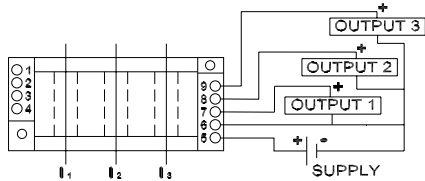

**CR4170** Three Element 0 - 5 Vdc Output

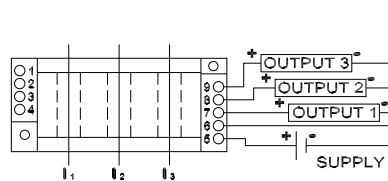

**CR4180** Three Element 4 - 20 mA DC Output

Note: The building installation must have a switch or circuit-breaker that is in close proximity and within easy reach of the operator. The switch or circuit breaker shall be marked as the disconnecting device for the equipment.

## Outline Drawing

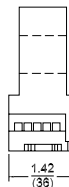
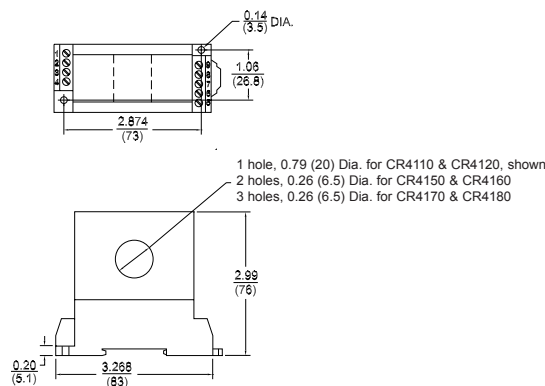

inch (mm)





# AC Current to Voltage Transducer

PANEL MOUNT RUGGED CONDITION, AVERAGE SENSING

The **CR4310** Series, current-to-voltage transducer produces a DC voltage output signal that is proportional to the input average RMS AC current. Designed for use with sinusoidal AC current signals, these devices provide an easy implementation of most AC current sensing requirements.



## Applications

- Directly connect to PLC high impedance inputs
- Sense motor stalls and short circuits
- Process control loops
- Industrial instrumentation

## Features

- Permanently calibrated and sealed for rugged environments
- Continuous operation at 150% of Full Scale
- Output overload protected
- Self-powered, requires no external power source
- 5 & 10 Vdc output available



**CR4310**      **CR4311**  
.93" Window

## Internet Resources <http://www.crmagnetics.com/>

- Pricing: [pricing/4310.html](http://www.crmagnetics.com/pricing/4310.html)
- Application Sheet: [pdf/ancr4310.pdf](http://www.crmagnetics.com/pdf/ancr4310.pdf),  
[pdf/ancr4310-2.pdf](http://www.crmagnetics.com/pdf/ancr4310-2.pdf)

## Part Numbers

**CR4310** -  0 - 5 Vdc output  
**CR4311** -  0 - 10 Vdc output

Add suffix for input range

		Accuracy
<b>5</b>	- 0-5 Aac	1.0
<b>10</b>	- 0-10 Aac	0.75
<b>15</b>	- 0-15 Aac	0.75
<b>20</b>	- 0-20 Aac	0.5
<b>30</b>	- 0-30 Aac	0.5
<b>40</b>	- 0-40 Aac	0.5
<b>50</b>	- 0-50 Aac	0.5
<b>75</b>	- 0-75 Aac	0.5
<b>100</b>	- 0-100 Aac	0.5
<b>150</b>	- 0-150 Aac	0.5
<b>200</b>	- 0-200 Aac	0.5

# AC Current to Voltage Transducer

## Specifications

Accuracy:.....	Depends on the range, see Part Numbers table	Operating Temperature Range:..	-30°C to +60°C
Calibrated Signal Out:.....	0 - 5 Vdc for CR4310 0 - 10 Vdc for CR4311	Storage Temperature Range:.....	-55°C to +85 °C
Max. Signal Out:.....	16 Vdc for CR4310 33 Vdc for CR4311	Shipping Weight:.....	1.5 pounds (.68 kg.)
Response Time:.....	250 ms max., 10-90% FS	Frequency:.....	50/60 Hz
Continuous Thermal Current Rating Factor:....	2.50 @ 30°C	Ripple:.....	1% Max. peak
Short Time Thermal Current Rating Factor:..	.60 x FS (1 Sec)	Insulation Class:.....	600 V, BIL 10 KV Full Wave
		Output Load:	4310 - 1 Meg Ω or Greater 4311 - 150 K Ω or Greater

## Connection Drawing

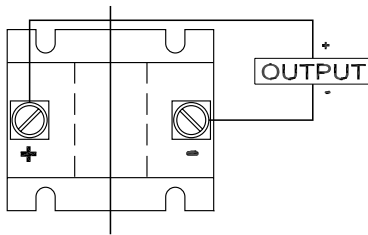

## Outline Drawing

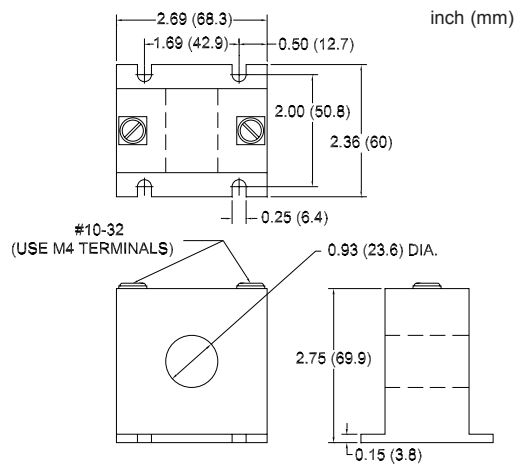

## Typical Application

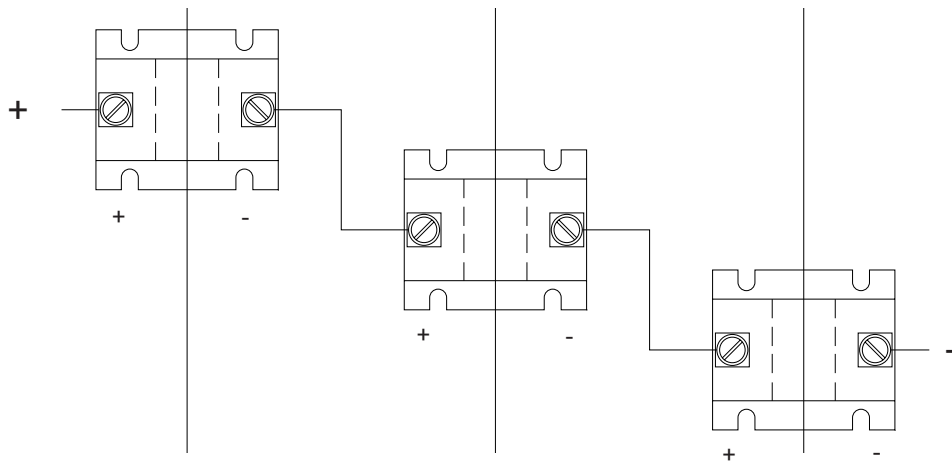

## 3-PHASE SYSTEMS

Three-phase systems may be monitored by attaching three transducers in series. The total output voltage will be the sum of each individual transducer. If each transducer is sized for the full-scale current, the output voltage will be 0-15 Vdc for the CR4310 Series (0-30 Vdc for the CR4311 Series) at 0 to 100% full-scale. As an alternate, each transducer may be sized for three times the full-scale current, then the output voltage for the CR4310 will be 0-5 Vdc for 0 to 100% full-scale.

CR Magnetics, Inc. 544 Axminister Dr. Fenton MO USA 63026 V: 636.343.8518 F: 636.343.5119

Web: <http://www.crmagnetics.com>

E-mail: [sales@crmagnetics.com](mailto:sales@crmagnetics.com)



# 2-Wire AC Current Transmitter

PANEL MOUNT RUGGED CONDITION, AVERAGE SENSING

The **CR4320** Series, Loop-powered, Current Transmitter produces 4 - 20 mA DC output current proportional to the input average RMS AC current. These devices provide long range monitoring of AC sinusoidal currents in an easy to install package.



## Applications

- Remote sensing of current from distant locations
- Sense motor stalls and short circuits
- Process control loops
- Industrial automation
- Electrically noisy environments

## Features

- Permanently calibrated and sealed for rugged environments
- Loop powered 2-wire connection eases installation
- Output overload protected
- Continuous operation at 130% full scale

Internet Resources <http://www.crmagnetics.com/>

- Pricing: [pricing/4320.html](#)
- Application Sheet: [pdf/ancr4320.pdf](#)



**5-200 Aac input**  
.93 Window



**300 and 400 Aac input**  
1.25 Window

## Part Numbers

**CR4320** -  2-Wire AC Current Transmitter

Add suffix for input range

		<b>.93" Window</b>	<b>1.25" Window</b>
<b>5</b>	-	0-5 Aac	<b>300</b> - 0-300 Aac
<b>10</b>	-	0-10 Aac	<b>400</b> - 0-400 Aac *
<b>15</b>	-	0-15 Aac	
<b>20</b>	-	0-20 Aac	* not UL recognized
<b>30</b>	-	0-30 Aac	
<b>50</b>	-	0-50 Aac	
<b>75</b>	-	0-75 Aac	
<b>100</b>	-	0-100 Aac	
<b>150</b>	-	0-150 Aac	
<b>200</b>	-	0-200 Aac	

# 2-Wire AC Current Transmitter

## Specifications

Accuracy:.....	±0.5% Full-Scale	Output Load:.....	0 to 600 Ω
Repeatability:.....	Less than 0.1%	Insulation Class:.....	600 V, BIL 10 KV Full Wave
Ripple & Noise:.....	1% max. P/P	Reverse Polarity Protection:.....	Yes
Calibrated Signal Out:.....	4 - 20 mA DC	Operating Temperature Range:	-30°C to +60°C
Response Time:.....	200 ms max.	Storage Temperature Range:.....	-55°C to +85°C
Max. Signal Out:.....	30 mA DC	Approximate Weight:.....	1.5 pounds (.68 kg)
Temperature Coefficient:.....	± 0.04%/°C	Short Time Thermal Current Rating Factor (30 Sec.):	
Supply Voltage:.....	24 Vdc ±10%	6.0 x Full Scale for AC ranges up to 200 Amp.	
Frequency:.....	50/60 Hz	4.0 x Full Scale for ranges 300 and 400 Amp.	
Continuous Thermal Rating Factor:..	1.33 @ 30°C.		

## Connection Drawing

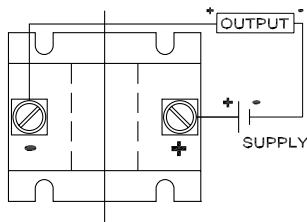

## Outline Drawings

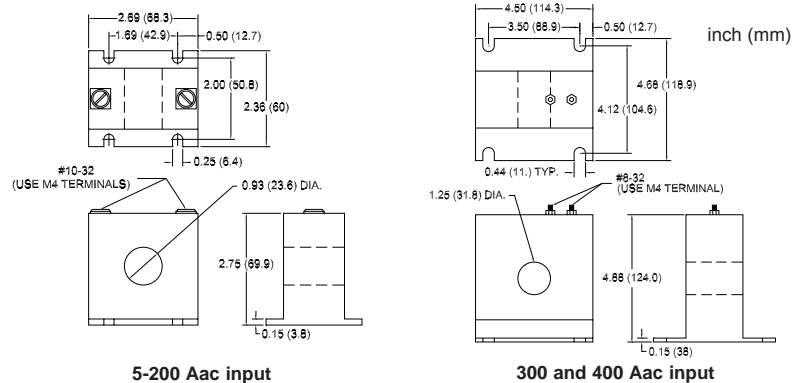

## Typical Application

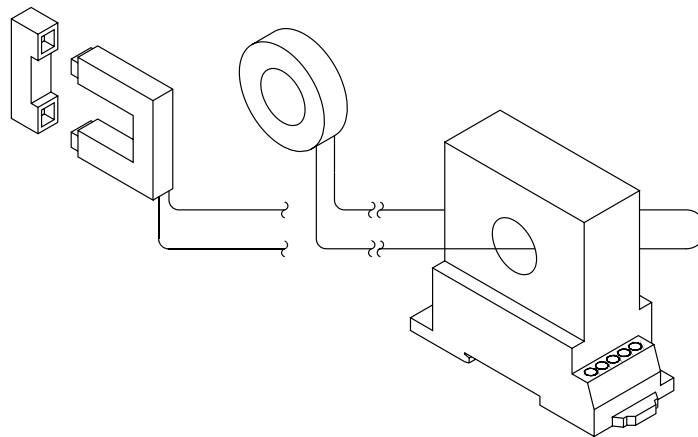

## EXTERNAL CURRENT TRANSFORMERS

The transducers and transmitters may be used with an external split-core or solid-core current transformer. The external transformer can be used to access remote loads or where the current-carrying wire is too large to fit through the window opening of the unit. A standard, 5 Amp secondary, commercial grade current transformer would be attached with the secondary leads threaded through the window opening. A transducer or transmitter with a 0-5 Amp input range would be selected. Request CR Magnetics current transformer catalog.



# 4-Wire AC Current Transmitter

PANEL MOUNT RUGGED CONDITION, AVERAGE SENSING

The **CR4340** Series Current Transmitter produces a calibrated 4 - 20 mA DC signal proportional to the average RMS input AC current. The output signal is produced by an internal current generator powered from an external 120 Vac supply.



## Applications

- Remote current sensing of distant locations
- Sense motor stalls and short circuits
- Process control loops
- Stand alone or small instrumentation systems
- Electrically noisy environments

## Features

- Permanently calibrated and sealed for rugged environments
- Direct attachment to instrumentation without the need of a DC power supply in the loop
- Output overload protected
- Continuous operation at 130% Full Scale

Internet Resources <http://www.crmagnetics.com/>

Pricing: [pricing/4340.html](#)  
 Application Sheet: [pdf/ancr4340-1.pdf](#)



**5-75 Aac input**  
.94" Window



**100-600 Aac input**  
2.13" Window

## Part Numbers

**CR4340** -  4-Wire AC Current Transmitter

Add suffix for input range

		.94" Window	2.13" Window	
5	-	0-5 Aac	100	- 0-100 Aac
			150	- 0-150 Aac
			200	- 0-200 Aac
20	—	0-10 Aac *	300	- 0-300 Aac
		0-15 Aac *	400	- 0-400 Aac
		0-20 Aac *	600	- 0-600 Aac
75	—	0-25 Aac *		
		0-50 Aac *		
		0-75 Aac *		

\* Range set with field selectable switch

# 4-Wire AC Current Transmitter

## Specifications

Accuracy:.....  $\pm 0.5\%$  Full-Scale  
 Ripple & Noise:..... 1% max., P/P  
 Calibrated Signal Out:..... 4-20 mA DC  
 Response Time:..... 150 ms max.  
 Supply Voltage:.....  $120 \pm 10\%$  Vac  
 Frequency:..... 50/60 Hz  
 Continuous Thermal Current Rating Factor:  
     1.50 @ 30°C for ranges up to 75 Amp.  
     1.33 @ 30°C for ranges 100 Amp. and over

Output Load:..... 0 - 1000  $\Omega$   
 Operating Temperature Range:..... -30°C to +60°C  
 Storage Temperature Range:..... -55°C to +85°C  
 Temperature Coefficient:.....  $\pm 0.02\%/^{\circ}\text{C}$   
 Max. Signal Out:..... 30 mA DC  
 Insulation Class:..... 600 V, BIL 10 KV Full Wave  
 Short Time Thermal Current Rating Factor (For 30 Sec.):  
     15.0 x Full Scale for AC ranges up to 75 Amp.  
     4.0 x Full Scale for ranges 400 Amp. and over

## Outline Drawings

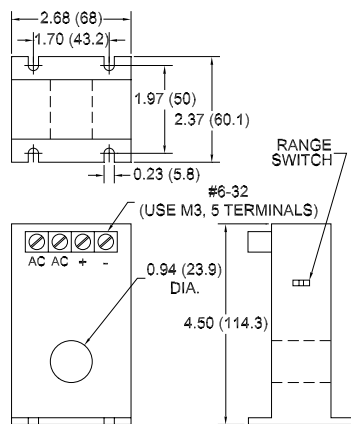

**5-75 Aac input**

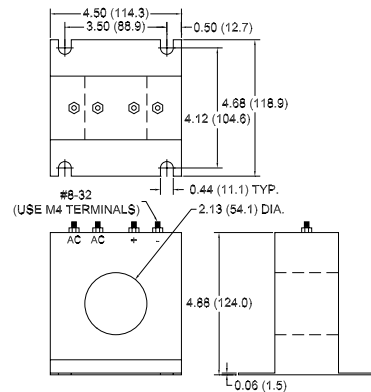

inch (mm)

**100-600 Aac input**

## Connection Drawings

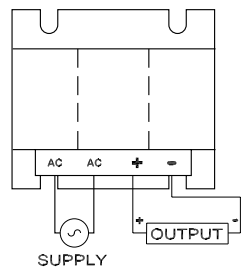

**CR4340**  
5 - 75 Aac

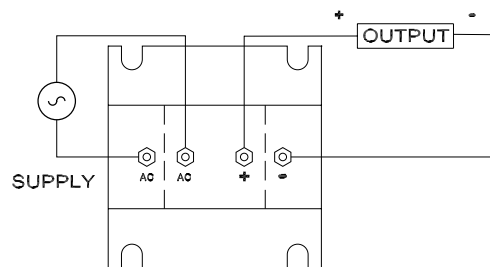

**CR4340**  
100 - 600 Aac



# Loop-Powered AC Current Transmitter

DIN RAIL / PANEL MOUNT, AVERAGE SENSING

The **CR4200** Series, Current Transmitters produce a calibrated 4-20 mA DC signal that is proportional to the average RMS input AC current. Designed for multi-point current sensing, these devices provide excellent features in a high value package. The output signal is generated from a user supplied 24 Vdc power supply within the output current loop.



**CR4220**

One Element - .79" Window  
0.5 to 50 Aac Range



**CR4260**

Two Element - .26" Window  
0.5 to 30 Aac Range

## Regulatory Agencies

- Approved to UL3111-1, First Edition, Amendment 2
- Approved to CAN/CSA-C22.2, No. 1010.1-92
- Meets requirement of IEC 61010-1 and BS EN 61010-1

## Applications

- Multi-point current sensing and control panels
- Remote current sensing
- Monitor motor faults
- Monitor heating elements
- Monitor lighting elements

## Features

- Relatively low cost
- 35mm DIN rail or panel mount
- High Accuracy
- Easy wiring
- Interfaces with most commercially available instrumentation
- Connection diagram printed on case

**Internet Resources** <http://www.crmagnetics.com/>

- Pricing: [pricing/4200.html](http://www.crmagnetics.com/pricing/4200.html)

See page 34 for typical applications

## Part Numbers

**CR4220** -  Single element with 4 to 20 mA DC output  
**CR4260** -  Two element with 4 to 20 mA DC output \*

\* Two element transducers are available only in ranges of 0.5 to 30 Aac

Add suffix for input range

<b>.5</b>	-	0-.5 Aac *
<b>5</b>	-	0- 5 Aac *
<b>10</b>	-	0-10 Aac *
<b>15</b>	-	0-15 Aac *
<b>20</b>	-	0-20 Aac *
<b>25</b>	-	0-25 Aac *
<b>30</b>	-	0-30 Aac *
<b>40</b>	-	0-40 Aac
<b>50</b>	-	0-50 Aac
Other Ranges Available		

# Loop-Powered AC Current Transmitter

## Specifications

Basic Accuracy:.....	0.5%	Insulation Voltage:.....	2500 Vdc
Thermal Drift:.....	500 PPM/°C	Loop Voltage:.....	24 Vdc
Operating Temperature:.....	0°C to +60°C	Frequency Range:.....	20Hz- 4 KHz
Installation Catagory:.....	CAT II	Compliance Voltage:...	16 to 28 Vdc
Polution Degree:.....	2	Typical Load:.....	0 To 300 Ω @ 24 Vdc
MTBF:.....	Greater than 100 K hours	Cleaning:.....	Water-dampened cloth
Altitude:.....	2000 meter max.	Response Time:.....	250 ms max., 0-90% FS
Response Time:.....	250 ms max., 0-90% FS	Relative Humidity:.....	80% for temperatures up to 31°C and decreasing linearly to 50% at 40°C
Calibration:.....	Average Sensing, RMS Calibrated		

## Connection Drawings

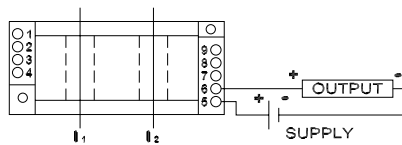

**CR4220**

One Element - 4 - 20 mA DC Output

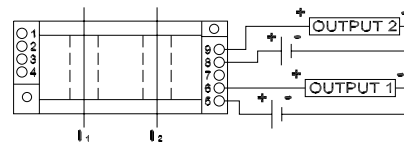

**CR4260**

Two Element 4 - 20 mA DC Output

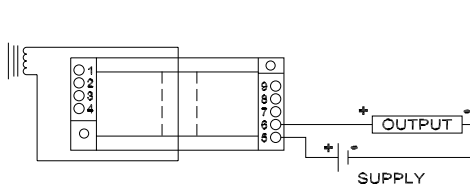

**CR4220**

One Element with external current transformer \*

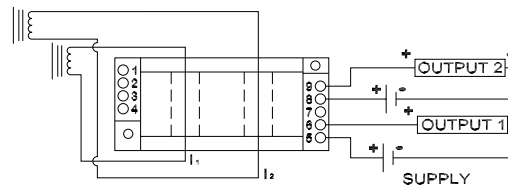

**CR4260**

Two Element with external current transformer \*

\* REQUEST CR MAGNETICS LOW AND MEDIUM VOLTAGE CURRENT TRANSFORMER CATALOG

Note: The building installation must have a switch or circuit-breaker that is in close proximity and within easy reach of the operator. The switch or circuit breaker shall be marked as the disconnecting device for the equipment.

## Outline Drawing

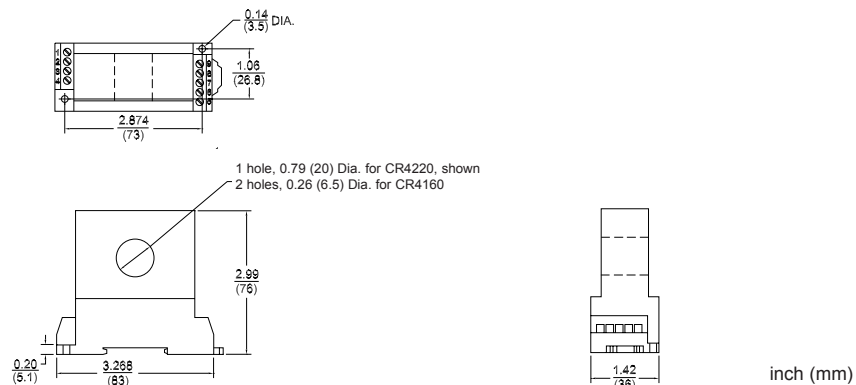

inch (mm)





# AC/DC Hall Effect Current Transducer

DIN RAIL / PANEL MOUNT, TRACING OUTPUT

The **CR5400** Series, AC/DC Hall Effect Current Transducers, are designed to provide a bipolar output that proportionally reflects (traces) the waveform of the input current. These devices are specifically targeted to be used in applications where multi-mode current sensing is required.

## Applications

- Inverter and multi-frequency drives
- Multi-mode ground paths carrying both AC and DC signals
- Feed back loop building block

## Features

- Output isolated from input
- Non-contact current sensing
- 35mm DIN Rail or Panel Mount
- Connection diagram printed on case

Internet Resources <http://www.crmagnetics.com/>

Pricing: [pricing/5400.html](http://www.crmagnetics.com/pricing/5400.html)



**CR5410**  
.79" Window

See page 35 for typical applications

## Part Numbers

**CR5410** -   $\pm 5$  Vac/dc output

Add suffix for input range

### .79" Window

<b>20</b>	-	$\pm 20$ A ac/dc
<b>30</b>	-	$\pm 30$ A ac/dc
<b>50</b>	-	$\pm 50$ A ac/dc
<b>75</b>	-	$\pm 75$ A ac/dc
<b>100</b>	-	$\pm 100$ A ac/dc
<b>150</b>	-	$\pm 150$ A ac/dc
<b>300</b>	-	$\pm 300$ A ac/dc

# AC/DC Hall Effect Current Transducer

## Specifications

Basic Accuracy:.....	1.0%	Supply Voltage:.....	24 Vdc $\pm$ 10%
Thermal Drift:.....	500 PPM/ $^{\circ}$ C	Frequency Range:.....	DC - 4 KHz
Operating Temperature:.....	0 $^{\circ}$ C to +50 $^{\circ}$ C	Output:.....	$\pm$ 5 Vac/DC
Insulation Voltage:.....	2500 Vdc	Output Load:.....	2 K $\Omega$ or greater
MTBF:.....	Greater than 100 K hours		

## Connection Drawing

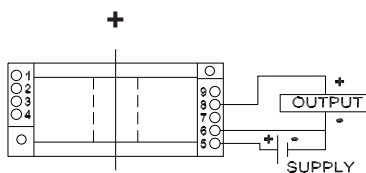

**CR5410**  
 $\pm$ 5 Vac/DC Output

## Outline Drawing

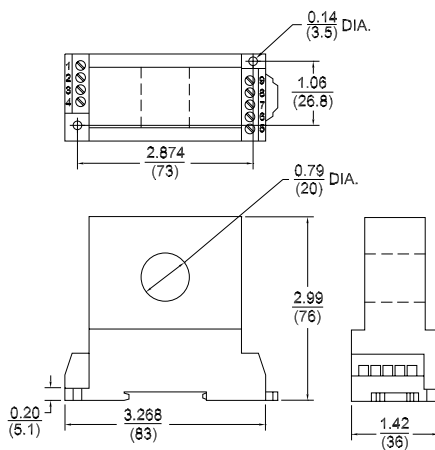

inch (mm)



# DC Current Transducer

DIN RAIL / PANEL MOUNT

The **CR5200** Series, DC Current Transducers are designed to provide a DC signal which is proportional to a DC sensed current. These devices are designed for direct current only, targeting them towards general and daily applications. The ranges 2 to 10 Amp utilize an advanced Magnetic Modulator technology and the ranges 20 amps and above utilize Hall Effect technology.

## Applications

- Battery chargers and systems
- DC motor drives
- Power supply management
- Mobile applications

## Features

- Closed loop sensing for accuracy
- 35mm DIN rail or panel mount
- 0 - 5 Vdc or 4 - 20 mA DC outputs
- Non-contact DC current sensing
- Connection diagram printed on case

Internet Resources <http://www.crmagnetics.com/>

Pricing: [pricing/5200.html](http://www.crmagnetics.com/pricing/5200.html)



**2 to 10 Adc input**  
.51" Window



**20 to 300 Adc input**  
.79" Window

See page 34 for typical applications

## Part Numbers

**CR5210** -  ± 5 Vdc output  
**CR5220** -  4 - 20 mA DC output

Add suffix for input range

<b>.51" Window</b>		<b>.79" Window</b>	
<b>2</b>	- 0-2 Adc	<b>20</b>	- 0-20 Adc
<b>5</b>	- 0-5 Adc	<b>30</b>	- 0-30 Adc
<b>10</b>	- 0-10 Adc	<b>50</b>	- 0-50 Adc
		<b>75</b>	- 0-75 Adc
		<b>100</b>	- 0-100 Adc
		<b>150</b>	- 0-150 Adc
		<b>300</b>	- 0-300 Adc

# DC Current Transducer

## Specifications

<p>Basic Accuracy:..... 1.0 %</p> <p>Thermal Drift:..... 500 PPM/°C</p> <p>Operating Temperature:..... 0°C to +50°C</p> <p>Response Time: ..... 250 ms. max.,0-90% FS</p> <p>Insulation Voltage:..... 2500 Vdc</p>	<p>Supply Voltage:..... 24 Vdc ±10%</p> <p>Frequency Range:..... DC only</p> <p>MTBF:..... Greater than 100 K hours</p> <p>Output Load:.....0-5 Vdc..... 2 K or greater</p> <p style="padding-left: 100px;">4-20 mA DC..... 0 - 300Ω</p>
--	--

## Connection Drawing

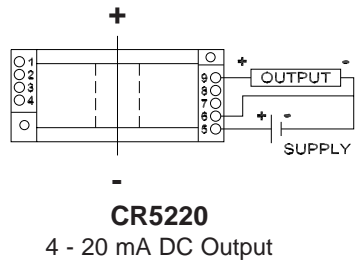
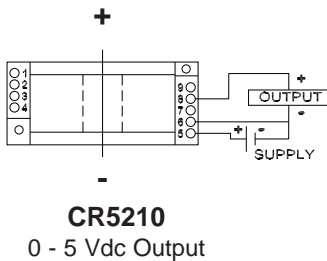

## Outline Drawing

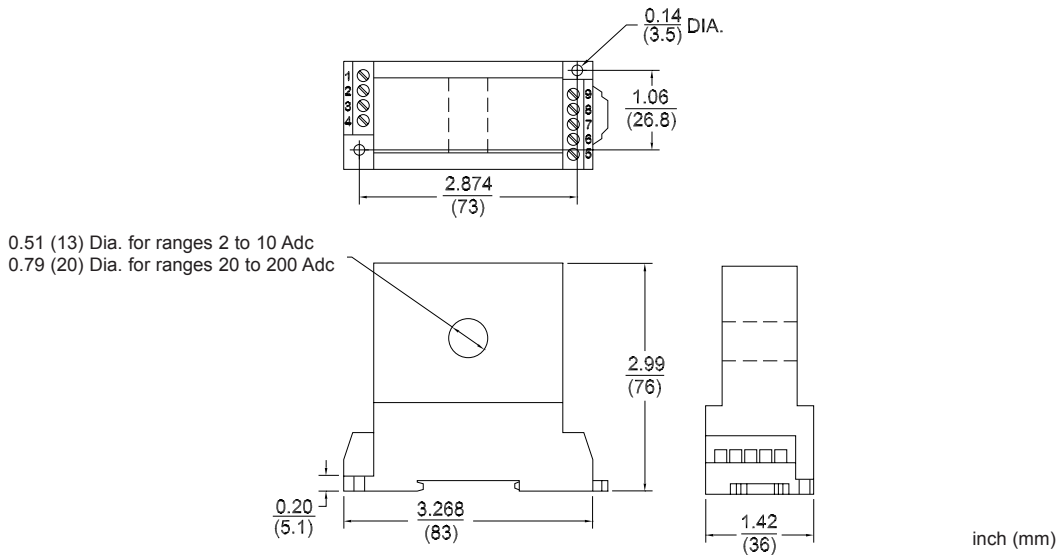



# True RMS AC Voltage Transducer

DIN RAIL / PANEL MOUNT, TRUE RMS

The **CR4500** Series, true RMS Voltage Transducers and Transmitters are designed for applications where AC voltage waveforms are not purely sinusoidal. More precise and accurate than other devices, these units are ideal in chopped wave and phase fired control systems.



**CR4510      CR4520**  
Single Phase



**CR4550      CR4560**  
**CR4570      CR4580**  
Three Phase

## Regulatory Agencies

- Approved to UL3111-1, First Edition, Amendment 2
- Approved to CAN/CSA-C22.2, No. 1010.1-92
- Meets requirement of IEC 61010-1 and BS EN 61010-1

## Applications

- Phase fired controlled devices
- Quickly varying voltage supplies
- Chopped waveform drivers
- Harmonic voltages

## Features

- 35mm DIN rail mount or panel mount
- Available with 0-5 Vdc or 4-20 mA DC outputs
- 24 Vdc powered
- Highest precision available
- Outputs isolated from inputs
- Connection diagram printed on case

**Internet Resources** <http://www.crmagnetics.com/>

- Pricing: [pricing/4500.html](http://www.crmagnetics.com/pricing/4500.html)

## Part Numbers

- CR4510** -  Single Phase with 0 to 5 Vdc Output
- CR4520** -  Single Phase with 4 - 20 mA DC Output
- CR4550** -  3-Phase 3-Wire with 0 to 5 Vdc Output
- CR4560** -  3-Phase 3-Wire with 4 - 20 mA DC Output
- CR4570** -  3-Phase 4-Wire with 0 to 5 Vdc Output
- CR4580** -  3-Phase 4-Wire with 4 - 20 mA DC Output

Add suffix for input range

- 50** - 0-50 Vac
- 150** - 0-150 Vac
- 250** - 0-250 Vac
- 500** - 0-500 Vac \*

Other Ranges Available

\* not UL recognized

# True RMS AC Voltage Transducer

## Specifications

Basic Accuracy:.....	0.5%	Supply Voltage:.....	24 Vdc $\pm$ 10%
Calibration:.....	True RMS sensing	Frequency Range:.....	20 Hz - 5 KHz
Thermal Drift:.....	500 PPM/ $^{\circ}$ C	Cleaning:.....	Water-dampened cloth
Operating Temperature:.....	0 $^{\circ}$ C to +60 $^{\circ}$ C	MTBF:.....	Greater than 100 K hours
Installation Category:.....	CAT II	Output Load:.....	0-5 Vdc - 2 K $\Omega$ or greater 4-20 mA dc - 0 to 300 $\Omega$
Polution Degree:.....	2	Relative Humidity:....	80% for temperatures up to 31 $^{\circ}$ C and decreasing linearly to 50% at 40 $^{\circ}$ C
Response Time: .....	250 ms		
Altitude:.....	2000 meter max.		
Insulation Voltage:.....	2500 Vdc		

## Connection Drawings

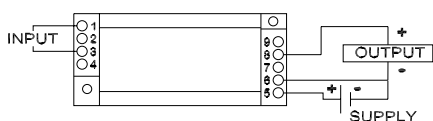

**CR4510**  
Single Phase - 0 - 5 Vdc Output

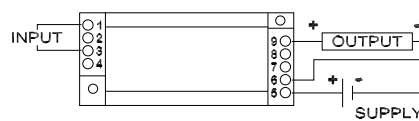

**CR4520**  
Single Phase - 4 - 20 mA DC Output

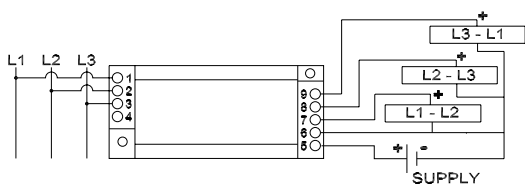

**CR4550**  
3 Phase, 3 Wire - 0 - 5 Vdc Output

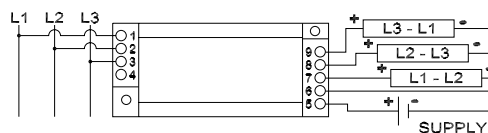

**CR4560**  
3 Phase, 3 Wire - 4-20 mA DC Output

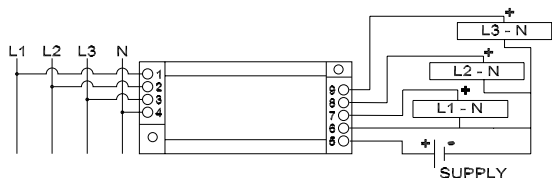

**CR4570**  
3 Phase, 4 Wire - 0 - 5 Vdc Output

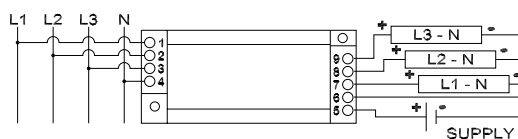

**CR4580**  
3 Phase - 4 Wire - 4 - 20 mA DC Output

## Outline Drawing

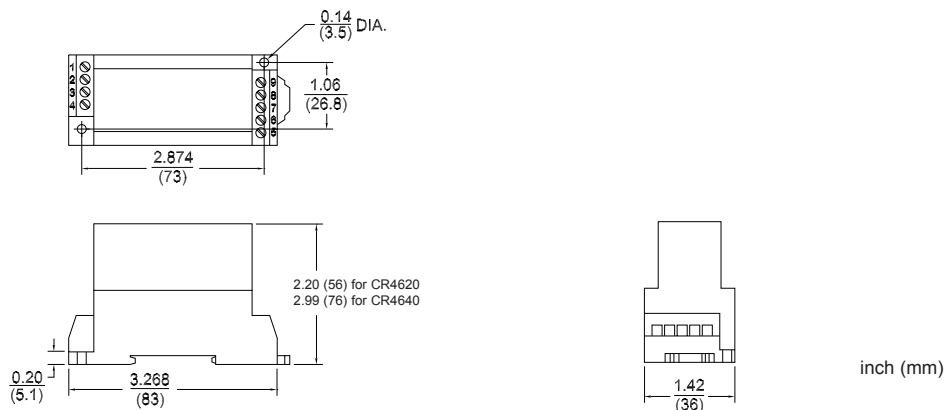



# 3-Phase AC Voltage Transmitter

PANEL MOUNT RUGGED CONDITION, AVERAGE SENSING

The **CR4730** Series, AC Voltage Transmitters are expanded scale instruments designed to accurately measure three-phase AC voltages. Each model produces three discrete 4-20 mA DC signals which are proportional to each three-phase AC voltage.



CR4730

CR4731

## Applications

- Sense phase loss
- Use in power calculations and applications
- Use in feed-forward motor drive controls

## Features

- Permanently calibrated and sealed for rugged environments
- Fully isolated outputs and inputs
- Expanded scale allows more accurate monitoring of small variances
- Available in line-to-line and line-to-neutral models

Internet Resources <http://www.crmagnetics.com/>

Pricing: [pricing/4730.html](http://pricing/4730.html)

Application Sheet: [pdf/ancr4730-1.pdf](http://pdf/ancr4730-1.pdf)

## Scaling

PART NUMBERS	APPLICATION	NOMINAL VOLTAGE RANGE	INPUT VOLTAGE RANGE	INPUT BURDEN (MAX)	TRANSFER FUNCTION $I_{\text{LOOP MA DC}} =$
CR4730-120	Line-to-line	120 V	90 V to 150 V	0.1 VA @ 240 V	$\frac{E_{\text{IN}} - 75}{3.75}$
CR4730-480 (Dual Range)	Line-to-line	240 V	180 V to 300 V	0.1 VA @ 265 V	$\frac{E_{\text{IN}} - 150}{7.5}$
		480 V	360 V to 600 V	0.1 VA @ 530 V	$\frac{E_{\text{IN}} - 300}{15}$
CR4731-120	Line-to-neutral	120 V	90 V to 150 V	0.1 VA @ 150 V	$\frac{E_{\text{IN}} - 75}{3.75}$
CR4731-277	Line-to-neutral	277 V	180 V to 300 V	0.1 VA @ 300 V	$\frac{E_{\text{IN}} - 150}{7.5}$

$E_{\text{IN}}$  = Volts RMS

## Part Numbers

- CR4730-120** 3 Phase, 3 Wire, Line to Line, 120 Vac Nominal  
**CR4730-480** 3 Phase, 3 Wire, Line to Line, 240/480 Vac Nominal, Dual Range  
**CR4731-120** 3 Phase, 4 Wire, Line-to-Neutral, 120 Vac Nominal  
**CR4731-277** 3 Phase, 4 Wire, Line-to-Neutral, 277 Vac Nominal

# 3-Phase AC Voltage Transmitter

## Specifications

Nominal Input Voltages:..... 120, 240, 277 & 480 Vac	Frequency:..... 50/60 Hz
Accuracy:..... $\pm 0.5\%$ Full-Scale (FS)	Max. Continuous Input Voltage: ... 600 V
Ripple On Output:..... Less than 1%	Operating Temperature Range: ... -30°C to +60°C
Calibrated Signal Out:..... 4 - 20 mA DC	Storage Temperature Range:..... -50°C to +85°C
Temperature Coefficient:..... $\pm 0.03\%/^{\circ}\text{C}$	Reverse Polarity Protection:..... Yes
Supply Voltage:..... 24 Vdc $\pm 10\%$	Load Resistance:..... 0-600 $\Omega$
Response Time:..... 1.50 sec. max., 10 - 90% FS	Shipping Weight:..... Approx: 1.3 Pounds (.59 kg)

## Connection Drawings

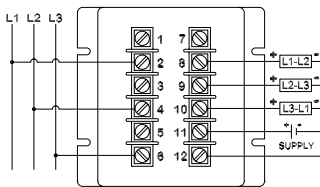

**CR4730-120**  
3 Phase, 3 Wire  
120 VL-L

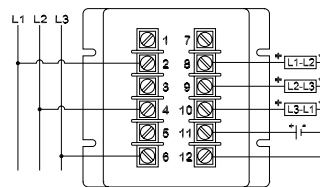

**CR4731-120**      **CR4731-277**  
3 Phase, 4 Wire      3 Phase, 4 Wire  
120 VL-N              277 VL-N

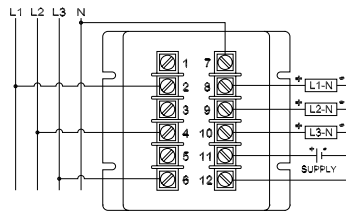

180-300 VL-L Connection

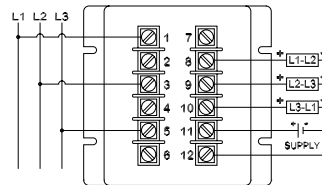

360-600 VL-L connection

**CR4730-480**  
3 Phase, 3 Wire

## Outline Drawing

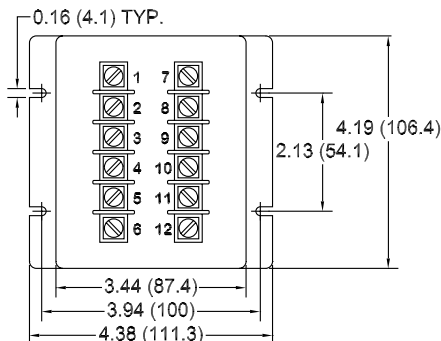

Top View

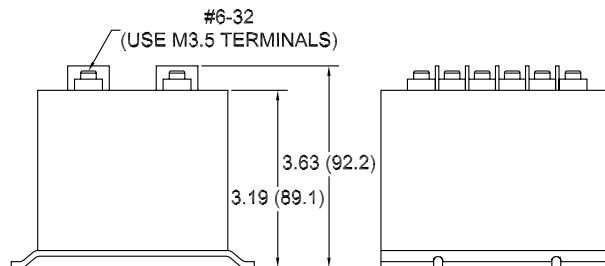

Side View

inch (mm)





# Loop-Powered AC Voltage Transmitter

4-20 mA DC LOOP POWERED, AVERAGE SENSING

The **CR4600** Series, Loop-Powered AC Voltage Transmitters are designed to provide a 4 - 20 mA DC output that is proportional to the average RMS AC voltage input. These devices are best suited for general applications, such as fixed frequency voltage supplies.



**CR4620**  
One Element Transmitter



**CR4640**  
Two Element Transmitter

## Regulatory Agencies

- Approved to UL3111-1, First Edition, Amendment 2
- Approved to CAN/CSA-C22.2, No. 1010.1-92
- Meets requirement of IEC 61010-1 and BS EN 61010-1

## Features

- Monitor for over/under voltage
- Sense phase loss
- Power monitoring
- Multi-point instrumentation needs

## Applications

- 35 DIN Rail or Panel Mount
- Outputs isolated from inputs
- One or two element
- Connection diagram printed on case

Internet Resources <http://www.crmagnetics.com/>

- Pricing: [pricing/4600.html](http://www.crmagnetics.com/pricing/4600.html)

See page 35 for typical applications

## Part Numbers

- CR4620** -  Single Element with 4 - 20 mA DC output  
**CR4640** -  Two Element with 4 - 20 mA DC output

Add suffix for input range

- 50** - 0-50 Vac  
**150** - 0-150 Vac  
**250** - 0-250 Vac  
**500** - 0-500 Vac \*

Other Ranges Available

\* not UL recognized

# Loop-Powered AC Voltage Transmitter

## Specifications

Basic Accuracy:.....	0.5%	Power Source:.....	Loop Powered
Thermal Drift:.....	500 PPM/°C	Loop Voltage:.....	24 Vdc
Operating Temperature:.....	0°C to +60°C	Frequency Range:.....	20Hz - 5 KHz
Polution Degree:.....	2	Typical Load:.....	0 - 300 Ω @ 24 Vdc
Installation Catagory:.....	CAT II	Compliance Voltage:..	16 to 28 Vdc
Response Time: .....	250 ms	MTBF:.....	Greater than 100 K hours
Insulation Voltage:.....	2500 Vdc	Cleaning:.....	Water-dampened cloth
Altitude:.....	2000 meter max.	Relative Humidity:.....	80% for temperatures up to 31°C and decreasing linearly to 50% at 40°C
Calibration:.....	Average Sensing, RMS Calibrated		

## Connection Drawings

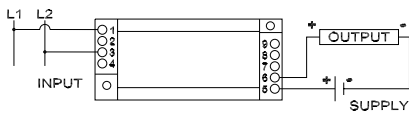

**CR4620** One Element 4 - 20 mA DC Output

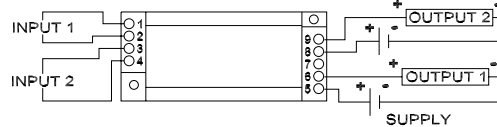

**CR4640** Two Element, 4 - 20 mA DC Output

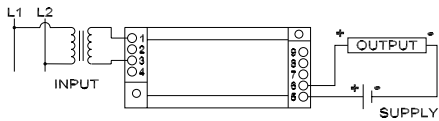

**CR4620** One Element with External Voltage Transformers \* \*

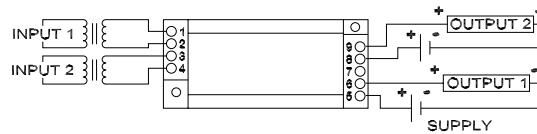

**CR4640** Two Element with External Voltage Transformers \* \*

\* \* USE CR MAGNETICS LOW AND MEDIUM VOLTAGE POTENTIAL TRANSFORMERS

Note: The building installation must have a switch or circuit-breaker that is in close proximity and within easy reach of the operator. The switch or circuit breaker shall be marked as the disconnecting device for the equipment.

## Outline Drawing

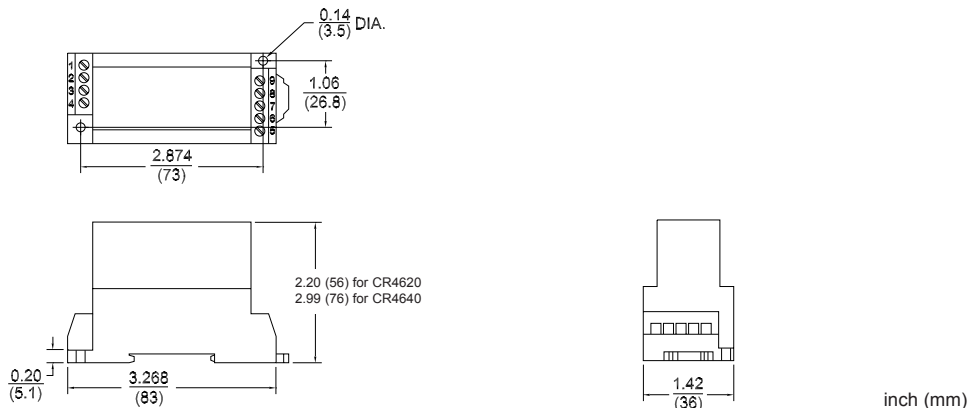



# DC Voltage Transducer

DIN RAIL / PANEL MOUNT

The **CR5300** Series, DC Voltage Transducers and Transmitters, are designed to provide an output DC signal that is proportional to the input DC voltage. These devices are especially suited for applications with a current shunt to monitor DC current.



## Regulatory Agencies

- Approved to UL3111-1, First Edition, Amendment 2
- Approved to CAN/CSA-C22.2, No. 1010.1-92
- Meets requirement of IEC 61010-1 and BS EN 61010-1

## Applications

- Power Supply over/under sensing
- Battery chargers and systems
- Mobile applications
- Power sensing

## Features

- Output isolated from input
- 0 - 5 Vdc or 4 - 20 mAdc outputs
- 35mm DIN rail or panel mount
- Connection diagram printed on case



CR5310

CR5320

Internet Resources <http://www.crmagnetics.com/>

Pricing: [pricing/5300.html](http://www.crmagnetics.com/pricing/5300.html)

## Part Numbers

**CR5310** -  0 -  $\pm 5$  Vdc Output  
**CR5320** -  4 - 20 mAdc Output

Add suffix for input range

**.01** - 0-0.01 Vdc  
**.05** - 0-0.05 Vdc  
**.1** - 0-0.1 Vdc  
**1** - 0-1 Vdc  
**10** - 0-10 Vdc  
**50** - 0-50 Vdc  
**150** - 0-150 Vdc  
**200** - 0-200 Vdc  
 other ranges available

## Specifications

Basic Accuracy:.....	0.5%	Insulation Voltage:....	2500 Vdc
Calibration:.....	RMS Calibrated	Supply Voltage:.....	24 Vdc $\pm$ 10%
Thermal Drift:.....	200 PPM/ $^{\circ}$ C	Frequency Range:....	DC
Operating Temperature:.....	0 $^{\circ}$ C to +60 $^{\circ}$ C	Output Load:.....	0-5 Vdc - 2 K $\Omega$ or Greater
Installation Catagory:.....	CAT II		4-20 mAdc - 0 to 300 $\Omega$
Polution Degree:.....	2	Cleaning:.....	Water-dampened cloth
Response Time: .....	250 ms	Relative Humidity:.....	80% for temperatures up to
Altitude:.....	2000 meter max.		31 $^{\circ}$ C and decreasing linearly to 50% at 40 $^{\circ}$ C
MTBF:.....	Greater than 100 K hours		

## Connection Drawings

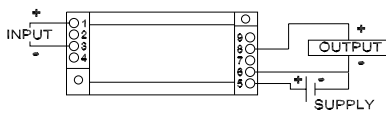

**CR5310**  
0 -  $\pm$ 5 Vdc Output

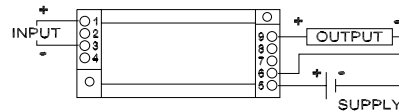

**CR5320**  
4 - 20 mAdc Output

Note: The building installation must have a switch or circuit-breaker that is in close proximity and within easy reach of the operator. The switch or circuit breaker shall be marked as the disconnecting device for the equipment.

## Outline Drawing

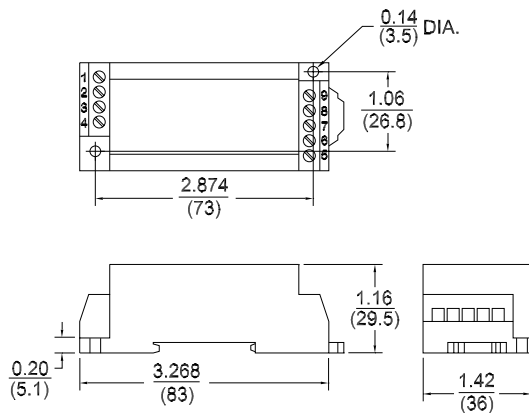

inch (mm)



# AC Power Transducer

DIN RAIL / PANEL MOUNT, AVERAGE SENSING

The **CR6200** Series, Power Transducers and Transmitters are designed to provide a controlled output that is proportional to the average power. These devices are specifically targeted to provide an efficient solution to most power sensing needs. Units are designed for operation in systems with sinusoidal voltage and current wave forms.



**CR6210, CR6211  
CR6220, CR6221**



**CR6230, CR6231  
CR6240, CR6241**



**CR6250, CR6251  
CR6260, CR6261**

## Regulatory Agencies

- Approved to UL3111-1, First Edition, Amendment 2
- Approved to CAN/CSA-C22.2, No. 1010.1-92
- Meets requirement of IEC 61010-1 and BS EN 61010-1

## Applications

- Energy Management
- Motor Efficiency
- Multi-point power sensing
- Remote power sensing over long distances

## Features

- 35mm DIN Rail or Panel Mount
- Ranges available for any power sensing need
- Active and Reactive power sensing
- 0 - 5 Vdc and 4 - 20 mAdc outputs
- Connection diagram printed on case

## Internet Resources <http://www.crmagnetics.com/>

- Pricing: [pricing/6200.html](http://www.crmagnetics.com/pricing/6200.html)
- Application Sheets: [pdf/an6230-1.pdf](http://www.crmagnetics.com/pdf/an6230-1.pdf),  
[pdf/an6250-1.pdf](http://www.crmagnetics.com/pdf/an6250-1.pdf)

## Part Numbers

- CR6210** -  -  1 Phase, Active Power with 0 - 5 Vdc Output
- CR6211** -  -  1 Phase, Reactive Power with 0 - 5 Vdc Output
- CR6220** -  -  1 Phase, Active Power with 4 - 20 mAdc Output
- CR6221** -  -  1 Phase, Reactive Power with 4 - 20 mAdc Output
- CR6230** -  -  3-Phase, 3-Wire, Active Power with 0 - 5 Vdc Output
- CR6231** -  -  3-Phase, 3-Wire, Reactive Power with 0 - 5 Vdc Output
- CR6240** -  -  3-Phase, 3-Wire, Active Power with 4 - 20 mAdc Output
- CR6241** -  -  3-Phase, 3-Wire, Reactive Power with 4 - 20 mAdc Output
- CR6250** -  -  3-Phase, 4-Wire, Active Power with 0 - 5 Vdc Output
- CR6251** -  -  3-Phase, 4-Wire, Reactive Power with 0 - 5 Vdc Output
- CR6260** -  -  3-Phase, 4-Wire, Active Power with 4 - 20 mAdc Output
- CR6261** -  -  3-Phase, 4-Wire, Reactive Power with 4 - 20 mAdc Output

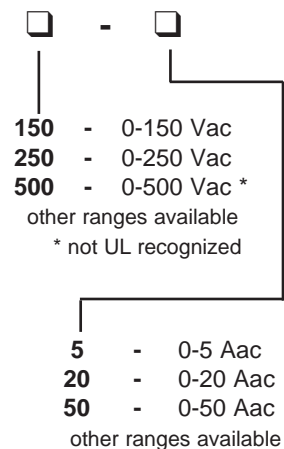

# AC Power Transducer

## Specifications

Basic Accuracy:..... 0.5%  
 Thermal Drift:..... 500 PPM/°C  
 Operating Temperature:..... 0°C to +60°C  
 Installation Category:..... CAT II  
 Pollution Degree:..... 2  
 Response Time: ..... 250 ms max. 0-90% FS  
 Supply Voltage:..... 12 to 24 Vdc  
 MTBF:..... Greater than 100 K hours

Frequency Range:..... 20Hz - 5 KHz, sine wave  
 Insulation Voltage:..... 2500 Vdc  
 Altitude:..... 2000 meter max.  
 Output Load:..... 4-20 mAdc -0 to 300 Ω  
 0-5 Vdc - 2K Ω or Greater  
 Cleaning:..... Water-dampened cloth  
 Relative Humidity:.... 80% for temperatures up to 31°C and decreasing linearly to 50% at 40°C

## Connection Drawings

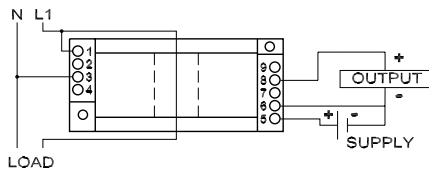

**CR6210 CR6211**  
 Single Phase, 0 - 5 Vdc Output

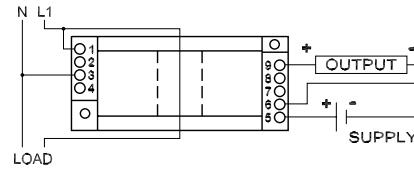

**CR6220 CR6221**  
 Single Phase, 4 - 20 mAdc Output

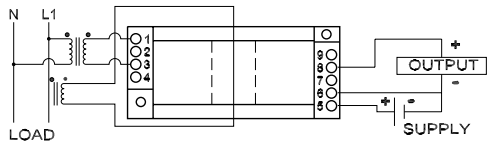

**CR6210 CR6211**  
 Single Phase, 0 - 5 Vdc Output  
 with external voltage transformers

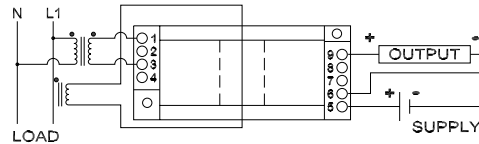

**CR6220 CR6221**  
 Single Phase, 4 - 20 mAdc Output  
 with external voltage transformers

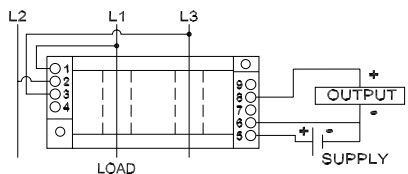

**CR6230 CR6231**  
 3 Phase - 3 Wire, 0 - 5 Vdc Output

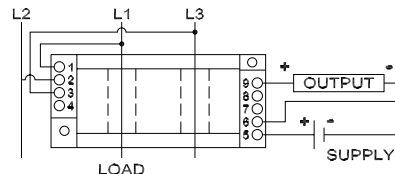

**CR6240 CR6241**  
 3 Phase - 3 Wire, 4 - 20 mAdc output

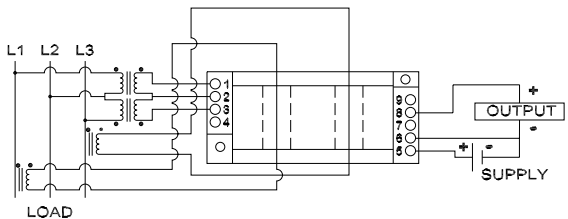

**CR6230 CR6231**  
 3 Phase - 3 Wire, 0 - 5 Vdc Output  
 with external voltage and  
 current transformers

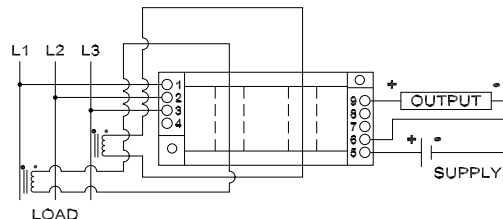

**CR6240 CR6241**  
 3 Phase - 3 Wire, 4 - 20 mAdc Output  
 with external current transformer

Note: The building installation must have a switch or circuit-breaker that is in close proximity and within easy reach of the operator. The switch or circuit breaker shall be marked as the disconnecting device for the equipment.

CR Magnetics, Inc. 544 Axminster Dr. Fenton MO USA 63026 V: 636.343.8518 F: 636.343.5119

Web: <http://www.crmagnetics.com>

E-mail: [sales@crmagnetics.com](mailto:sales@crmagnetics.com)

## Connection Drawings

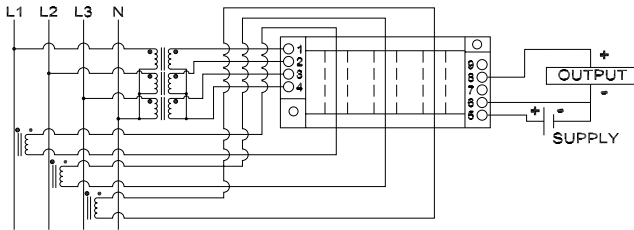

**CR6250 CR6251**  
Three Phase - 4 Wire, 0 - 5 Vdc Output  
shown with external voltage and  
current transformers

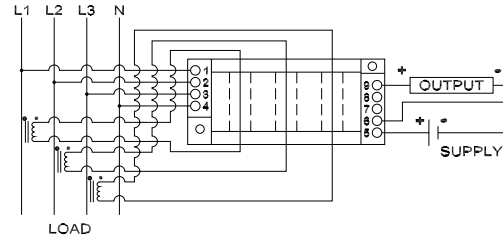

**CR6260 CR6261**  
Three Phase - 4 Wire, 4 - 20 mAdc Output  
shown with external current transformers

## Typical Application

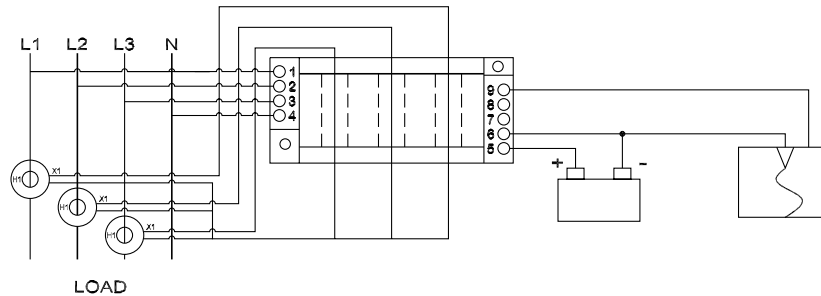

## POWER TRANSDUCER

A university campus needs to monitor the power coming into each building and record the results at a central location. The incoming feeds are rated at 480/277, 2000 amps, 3-phase, 4-wire Y.

An ANSI Metering Class Current Transformer, part number CR170RL-202, is selected from the CR Magnetics current transformer catalog to convert the full-load current down to 5 Amps for input to the transducer. The voltage legs are connected directly to the transducer.

## Outline Drawing

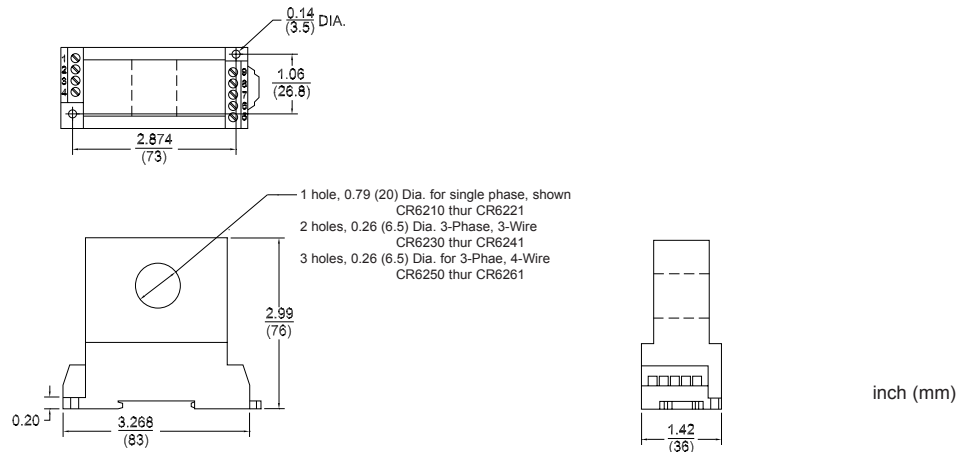

# AC Motor Loads & U.S. Standard Voltages

## A C Motor Loads \*

HP	MOTOR FULL LOAD CURRENTS								MAXIMUM LOCKED ROTOR CURRENTS						
	SINGLE PHASE		3-PHASE A.C. INDUCTION						3-PHASE A.C. INDUCTION						
	115 V	230 V	115 V	200 V	230 V	460 V	575 V	2300 V	4160 V	200 V	220/230 V	440/460 V	550/575 V	2300 V	4160 V
1/2	9.8	4.9	4	2.3	2	1	.8			23	20	10	8		
3/4	13.8	6.9	5.6	3.2	2.8	1.4	1.1			29	25	12.5	10		
1	16	8	7.2	4.15	3.6	1.8	1.4			34.5	30	15	12		
1 1/2	20	10	10.4	6	5.2	2.6	2.1			46	40	20	16		
2	24	12	13.6	7.8	6.8	3.4	2.7			57.5	50	25	20		
3	34	17		11	9.6	4.8	3.9			73.5	64	32	25		
5	56	28		17.5	15.2	7.6	6.1			106	92	46	37		
7 1/2	80	40		25	22	11	9			146	127	63	51		
10	100	50		32	28	14	11			186	162	81	65		
15				48	42	21	17			267	232	116	93		
20				62	54	27	22			334	290	145	116		
25				78	68	34	27			420	365	182	146	35	19
30				92	80	40	32			500	435	217	174	41	23
40				120	104	52	41			667	580	290	232	55	30
50				150	130	65	52			834	725	362	290	69	38
60				177	154	77	62	16	8.9	1000	870	435	348	83	46
75				221	192	96	77	20	11	1250	1085	592	435	104	57
100				285	248	124	99	26	14.4	1670	1450	725	580	139	76
125				358	312	156	125	31	17	2085	1815	907	726	173	96
150				415	360	180	144	37	20.5	2500	2170	1085	870	208	115
200				550	480	240	192	49	27	3340	2900	1450	1160	278	153
OVER 200 HP APPROX. AMPS / HP					2.75	2.40	1.20	.96	.24		.133				

\*This information provided as reference only. Consult motor manufacturer and related standards for additional information.

## U.S. STANDARD VOLTAGES

### SINGLE-PHASE

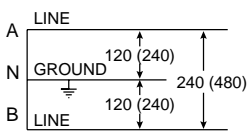

120/240 V, 3 W (240/480 V, 3 W)  
THREE-WIRE

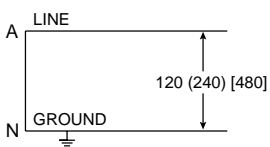

120 V, 2 W (240 V, 2 W) [480 V, 2 W]  
TWO-WIRE

### POLYPHASE

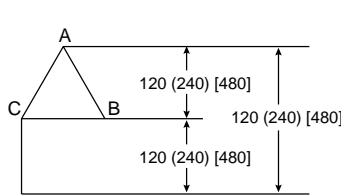

120 V, 3 W (240 V, 3 W) [480 V, 3 W]  
THREE-PHASE, THREE-WIRE

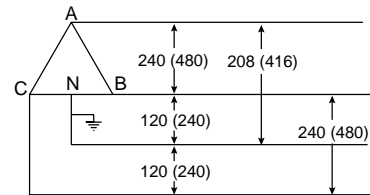

240/120 V, 4 W (480/240 V, 4 W)  
THREE-PHASE, FOUR-WIRE DELTA

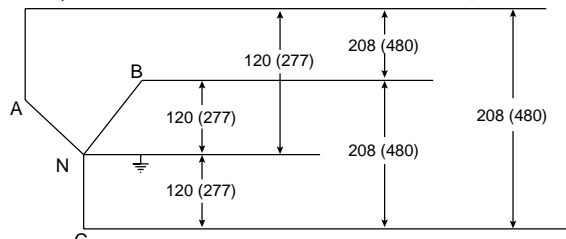

208Y/120 V, 4 W (480Y/277 V, 4 W)  
THREE-PHASE, FOUR-WIRE WYE





# Frequency Transducer

DIN RAIL / PANEL MOUNT

The **CR6600** Series, Frequency Transducers and Transmitters are designed to give a DC output that is proportional to an input frequency value. These devices are especially suited to variable frequency systems.

## Applications

- Applications monitor generator sets
- Multi-frequency control and monitoring
- Inverter drives and systems
- Power quality monitoring

## Features

- Outputs isolated from inputs
- Ranges available for any application
- Sine, square and zero crossover waveforms
- 35 DIN rail or panel mount
- Connection diagram printed on case



**CR6610**  
**CR6611**  
**CR6612**

**CR6620**  
**CR6621**  
**CR6622**

**Internet Resources** <http://www.crmagnetics.com/>

Pricing: [pricing/6600.html](http://www.crmagnetics.com/pricing/6600.html)

## Part Numbers

- CR6610** -  Sine wave sensing with 0 - 5 Vdc Output
- CR6611** -  Square wave sensing with 0 - 5 Vdc Output
- CR6612** -  Zero crossover sensing with 0 - 5 Vdc Output
- CR6620** -  Sine wave sensing with 4 - 20 mAdc Output
- CR6621** -  Square wave sensing with 4 - 20 mAdc Output
- CR6622** -  Zero crossover sensing with 4 - 20 mAdc Output

Add suffix for input range

**100** - 0-100 Hz  
**500** - 0-500 Hz  
**5000** - 0-5000 Hz

Other Ranges Available

# Frequency Transducer

## Specifications

Basic Accuracy:.....	0.5%	Supply Voltage:.....	24 Vdc $\pm$ 10%
Thermal Drift:.....	500 PPM/ $^{\circ}$ C	Output Load:.....	4-20 mA <sub>dc</sub> - 0 to 300 $\Omega$
Operating Temperature:.....	0 $^{\circ}$ C to +50 $^{\circ}$ C		0-5 Vdc - 2K $\Omega$ or Greater
Response Time: .....	250 ms. max, 0-90 % FS	Input Voltage:.....	20 to 250 V Peak,
Insulation Voltage:.....	1500 Vdc		(other voltage ranges available)
MTBF:.....	Greater than 100 K hours		

## Connection Drawings

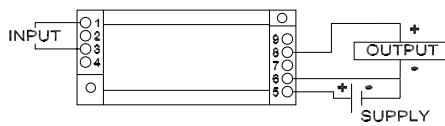

**CR6610**  
0 - 5 Vdc Output

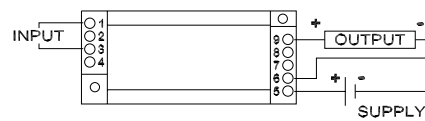

**CR6620**  
4 - 20 mA<sub>dc</sub> Output

## Outline Drawing

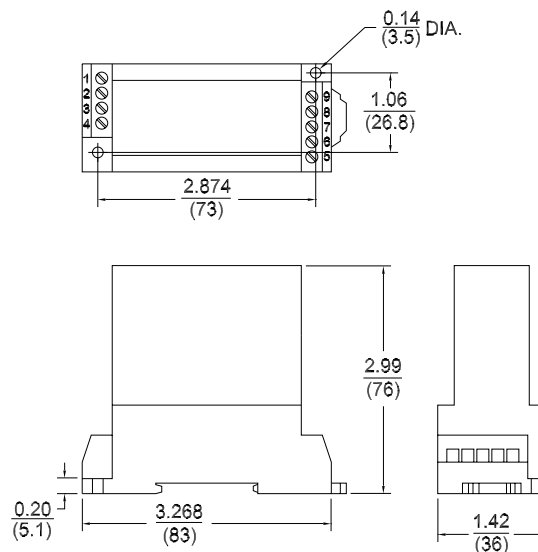

inch (mm)

## Typical Applications

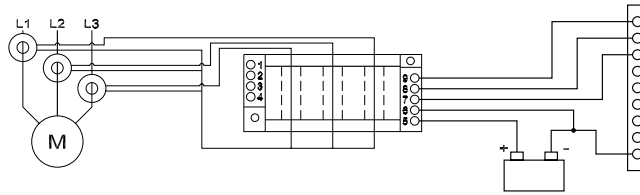

This illustrates a typical application for monitoring current to a 3-Phase motor. External current transformers are attached to each of the three incoming power lines. The secondary leads from each current transformer are routed through the window openings in the CR4170 True RMS Current Transducer. A standard 5 Amp secondary current transformer is recommended to be attached to a transducer rated for 5 Amp input. With the transducer attached to a PLC, the over/under current and phase loss conditions can be monitored.

### OVER/UNDER CURRENT MONITORING

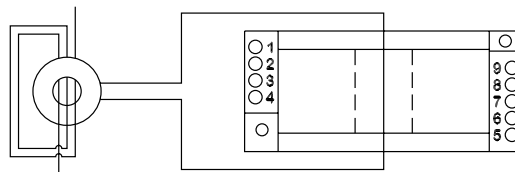

Looping the primary current-carrying wire several times through the window opening may change the scaling factor. The “actual” measurement range will be the nameplate rating of the transducer divided by the number of wire passes. For example, the CR4220-30 has a nameplate rating of 0-30 Aac. Three passes of the wire through the window opening will then provide an effective range of 0-10 Aac (30/3).

### LOOP-POWERED AC CURRENT TRANSMITTER

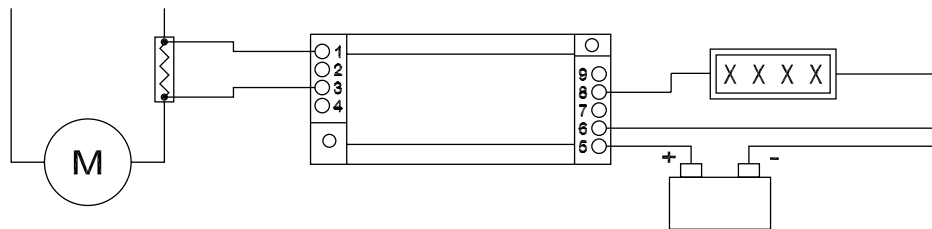

DC current may be monitored by using the voltage transducer attached to a resistive shunt. The illustration shows a CR5310-.05 transducer with an input range of 0-50 mv attached to a standard 50 mv resistive shunt. The output is attached to a standard 0-5 Vdc panel meter.

### DC CURRENT MONITORING

# Typical Applications

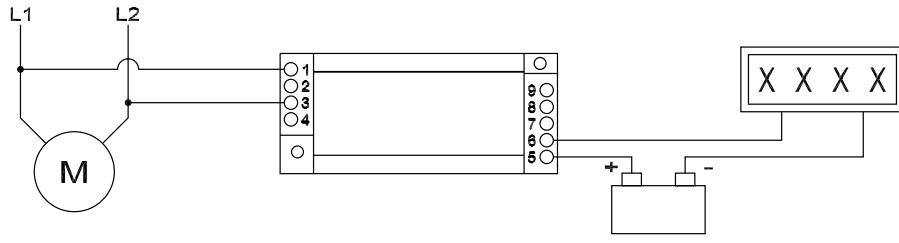

This illustrates a typical application for monitoring the voltage supply to a motor. The transmitter is attached to the incoming voltage supply leads. Use the CR4600 or CR4700 series for an AC supply and the CR5300 series for a DC supply. The transmitter output is attached to standard 4-20 ma, loop-powered panel meter. The transmitter may also be attached to a PLC to monitor for over/under voltage and phase loss.

## VOLTAGE MONITORING

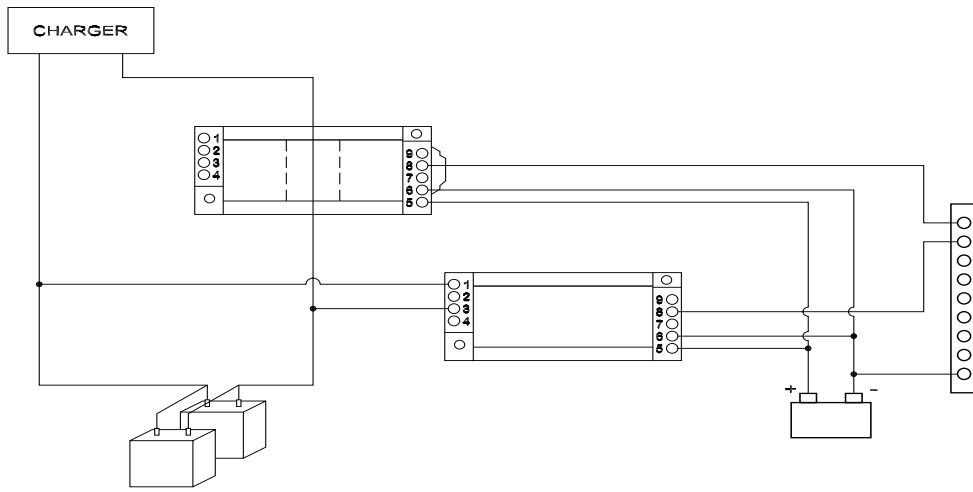

A plant manager needs to record the total charge to a bank of batteries. A CR5210 DC Current Transducer is attached to one of the incoming current lead and a CR5310 is attached to the incoming voltage lines. The output from each transducer is attached to a 0-5 Vdc analog input module on a PLC. The PLC computes the product of the current and voltage for the total power usage.

## DC POWER MEASUREMENT

## 3-Phase Balanced Circuits

### 3-Phase Delta

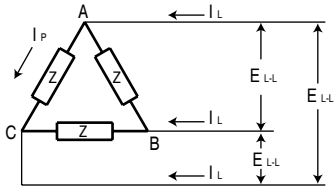

$$P = 1.73 E_{L-L} I_L \cos \theta = \frac{3(E_{L-L})^2}{Z}$$

$$Z = \frac{1.73 E_{L-L}}{I_L}$$

$$I_P = \frac{I_L}{1.73}$$

- The current in each element is equal to the line current  $I_L$  divided by  $\sqrt{3}$ .
- The voltage across each element is equal to the line voltage  $E_{L-L}$ .
- The impedance of each element is equal to  $\sqrt{3}$  times the voltage across each element divided by the line current.
- The voltage across the elements are  $120^\circ$  out of phase.
- The currents in the elements are  $120^\circ$  out of phase.
- The power is equal to  $\sqrt{3}$  times voltage across each element times the current  $I_L$  times  $\cos \theta$ .

$P$  = power in watts

$\theta$  = phase angle in degrees

### 3-Phase WYE

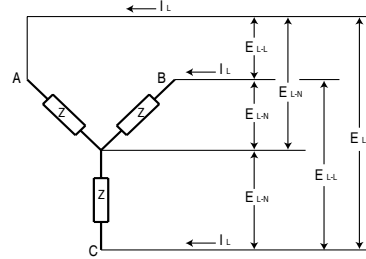

$$P = 3 E_{L-N} I_L \cos \theta = 1.73 E_{L-L} I_L \cos \theta$$

$$I_L = \frac{E_{L-N}}{Z} = \frac{E_{L-L}}{1.73 Z}$$

$$E_{L-N} = \frac{E_{L-L}}{1.73}$$

$$Z = \frac{E_{L-L}}{1.73 I_P}$$

- The current in each element is equal to the line current  $I_L$ .
- The voltage across each element  $E_{L-N}$  is equal to the line voltage  $E_{L-L}$  divided by  $\sqrt{3}$ .
- The impedance of each element is equal to line voltage  $E_{L-L}$  divided by  $\sqrt{3}$  times the line current.
- The voltages across the elements are  $120^\circ$  out of phase.
- The currents in the elements are  $120^\circ$  out of phase.
- The power is equal to 3 times line voltage  $E_{L-N}$  times line current times  $\cos \theta$ .
- For a balanced load the current in the neutral is equal to zero.

## 3-Phase Open Leg Circuits

### 3-Phase Delta

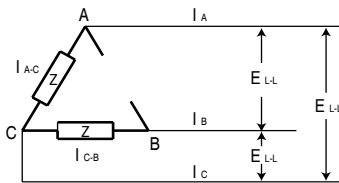

$$P = \frac{2(E_{L-L})^2}{Z}$$

$$I_{A-C} = I_{C-B} = I_A = I_B = \frac{E_{L-L}}{Z}$$

$$I_C = 1.73 I_A = 1.73 I_B$$

- The current in each non-open element is equal.
- The current in the connecting leg of the non-open elements is  $\sqrt{3}$  times the current in any other leg.

### 3-Phase WYE (No neutral)

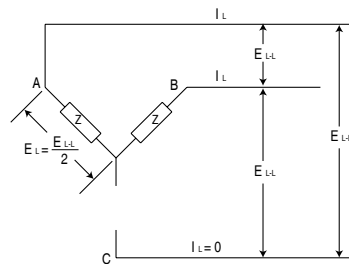

$$P = E_{L-L} I_L \cos \theta$$

$$I_L = \frac{E_{L-L}}{2 Z}$$

- The current in each non-open element is equal to the line current.
- The voltage across each non-open element is equal to the line voltage divided by 2.
- The power is equal to the line voltage times the line current times  $\cos \theta$ .



**Manufacturers & Designers Of Electrical Current & Power Monitoring Products  
For Industrial Market Applications Throughout The World**

**CR MAGNETICS, INC.**

**544 Axminister Drive  
Fenton, MO 63026 USA**

**PHONE: 636 343-8518**

**FAX: 636 343-5119**

**E-MAIL: [sales@crmagnetics.com](mailto:sales@crmagnetics.com)**

**WEB SITE: [www.crmagnetics.com](http://www.crmagnetics.com)**

Code TRANSDUCER 03A