

Ref: CTSR 0.3-P, CTSR 0.6-P

For the electronic measurement of current: DC, AC, pulsed..., with galvanic isolation between the primary (high power) and the secondary circuit (electronic circuit).

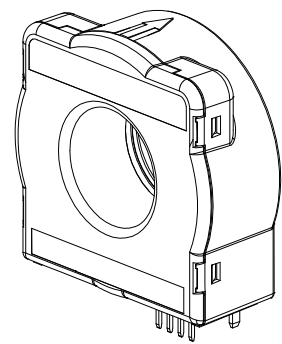
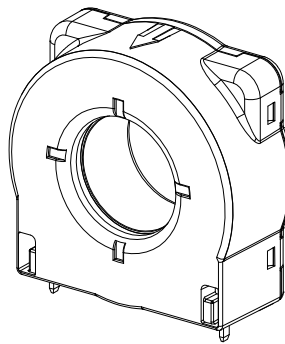

Features

- Closed loop (compensated) current transducer
- Voltage output
- Single supply voltage
- Isolated plastic case material recognized according to UL 94-V0
- PCB mounting.

Advantages

- High accuracy
- Very low offset drift over temperature
- Wide aperture (20.1 mm)
- High overload capability
- High isolation capability
- Reference pin with two modes, Ref In and Ref Out
- Degauss and test functions.

Applications

- Residual current measurement
- Leakage current measurement in transformerless PV inverters
- First human contact protection of PV arrays
- Failure detection in power sources
- Symmetrical fault detection (e.g. after motor inverter)
- Leakage current detection in stacked DC sources
- Single phase or three phase nominal current measurement up to $\pm 30 \text{ A}$ per wire (DC or AC).

Standards

- EN 50178
- IEC 61010-1 (safety).

Application Domain

- Industrial
- Suitable to fulfil VDE 0126-1-1 and UL 1741.

Absolute maximum ratings

Parameter	Symbol	Unit	Value
Supply voltage	V_C	V	7
Primary conductor temperature		°C	110
Impulse overload (100 μ s, 500 A/ μ s)		A	3300

Stresses above these ratings may cause permanent damage. Exposure to absolute maximum ratings for extended periods may degrade reliability.

Isolation characteristics

Parameter	Symbol	Unit	Value	Comment
RMS voltage for AC isolation test 50/60Hz/1 min	V_d	kV	5.4	
Impulse withstand voltage 1.2/50 μ s	\hat{V}_w	kV	10.1	
Partial discharge extinction voltage @ 10 pC (rms)	V_e	kV	1.65	
Clearance distance (pri. - sec.)	dCl	mm	11	Shortest distance through air
Creepage distance (pri. - sec.)	dCp	mm	11	Shortest path along device body
Comparative tracking index	CTI	V	600	
Application example	-		1000 V CAT III PD2	Basic isolation, non uniform field according to EN 50178
Application example	-		600 V CAT III PD3	Basic isolation, non uniform field according to EN 50178, IEC 61010
According to UL 508: primary potential involved in Volt rms AC or DC	-	V	600	For use in a pollution degree 3 environment
Primary conductor shall be connected after an overvoltage device or system evaluated by standard UL 1449.				

Environmental and mechanical characteristics

Parameter	Symbol	Unit	Min	Typ	Max	Comment
Ambient operating temperature	T_A	°C	-40		105	
Ambient storage temperature	T_S	°C	-50		105	
Mass	m	g		28		
Standards	EN 50178, IEC 61010-1, UL 508					

Electrical data CTSR 0.3-P

 At $T_A = 25^\circ\text{C}$, $V_C = +5\text{ V}$, output voltage referred to V_{REF} unless otherwise noted.

Parameter	Symbol	Unit	Min	Typ	Max	Comment
Primary nominal residual current rms	I_{PRN}	mA		300		
Primary residual current, measuring range	I_{PRM}	mA	-500		500	
Supply voltage	V_C	V	4.75	5	5.25	
Current consumption	I_C	mA	16	17.5	21.6	+ I_p (mA)/ N_s With $N_s = 1000$ turns - $40^\circ\text{C} \dots 105^\circ\text{C}$
Reference voltage @ $I_p = 0$	V_{REF}	V	2.495	2.5	2.505	Internal reference
External reference voltage	V_{REF}	V	2.3		4	Internal resistance of V_{REF} input = 499 Ω Note 1
Electrical offset current referred to primary (Note 2)	I_{OE}	mA	-24	+7	24	
Temperature coefficient of V_{OE} @ $I_p = 0$	TCV_{OE}	ppm/K		50	570	ppm/K of 2.5 V - $40^\circ\text{C} \dots 105^\circ\text{C}$
Theoretical sensitivity	G_{th}	V/A		4		
Sensitivity error (Note 2)	ϵ_G	%	-1.6	0.5	1.6	$R_L > 500\text{ k}\Omega$
Temperature coefficient of G	TCG	ppm/K			± 230	- $40^\circ\text{C} \dots 85^\circ\text{C}$
					± 400	- $40^\circ\text{C} \dots 105^\circ\text{C}$
Linearity error	ϵ_L	% of I_{PRM}		0.5	1	
Reaction time @ 10 % of I_{PRN}	t_{ra}	μs		7		$R_L > 500\text{ k}\Omega$, $di/dt > 5\text{ A}/\mu\text{s}$
Response time @ 90 % of I_{PRN}	t_r	μs		50		$R_L > 500\text{ k}\Omega$, $di/dt > 5\text{ A}/\mu\text{s}$
Frequency bandwidth (- 1 dB)	BW	kHz		3.5		$R_L > 500\text{ k}\Omega$
Output voltage noise (1 Hz .. 10 kHz)	V_{no}	mV rms		6		$R_L > 500\text{ k}\Omega$
Magnetic offset current referred to primary (1000 x I_{PRN})	I_{OM}	mA		17		
Accuracy (Note 3)	X	%			1.9	$= (\epsilon_G^2 + \epsilon_L^2)^{1/2}$
Output voltage referred to GND (during Degauss cycle)		V		0.3	0.5	Note 1
Output voltage referred to V_{REF} (Test current)		V	$V_{OE} +$ 0.7	$V_{OE} +$ 1.2	$V_{OE} +$ 1.7	Note 1

Notes: 1) See "Application information" section.

2) Only with a primary nominal residual current, see paragraph "Primary nominal residual current and primary nominal current".

3) Accuracy @ T_A and I_p : $X_{TA} = (X^2 + (TCG \cdot 100 \cdot (T_A - 25))^2 + (TCV_{OE} \cdot 2.5 \cdot (T_A - 25) / G_{th} \cdot 100 / I_p)^2)^{1/2}$

Typical performance characteristics CTSR 0.3-P

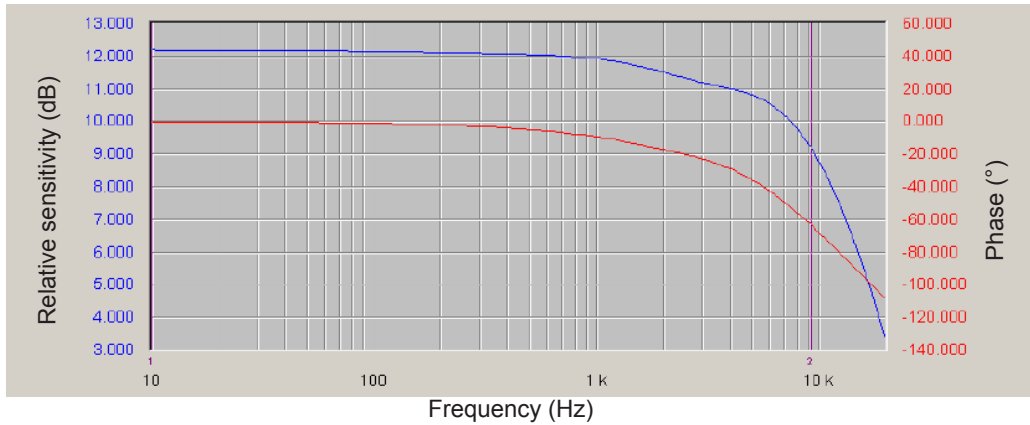

Figure 1: Frequency response

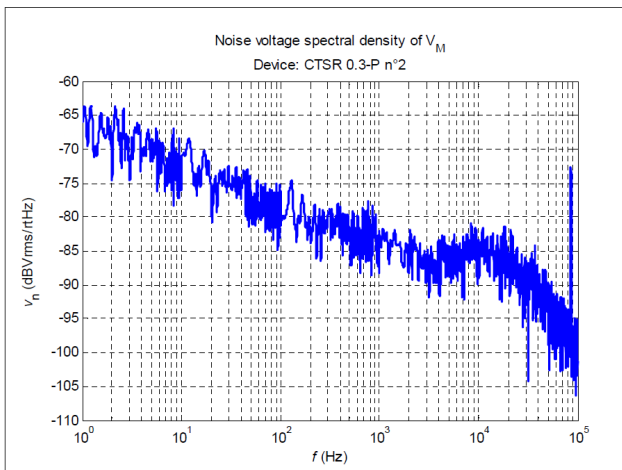

Figure 2: Output noise, spectral density

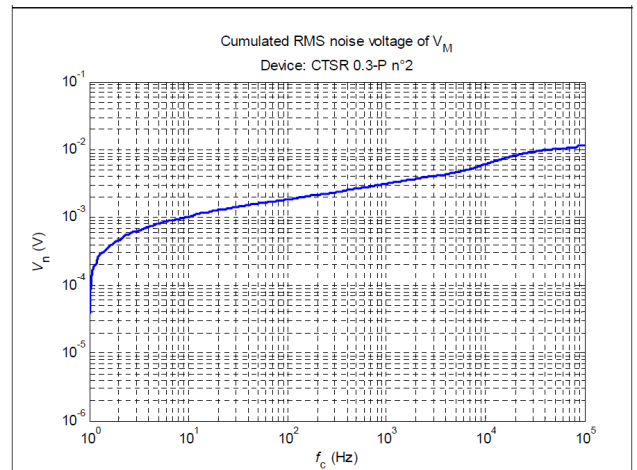

Figure 3: Output noise, cumulated rms

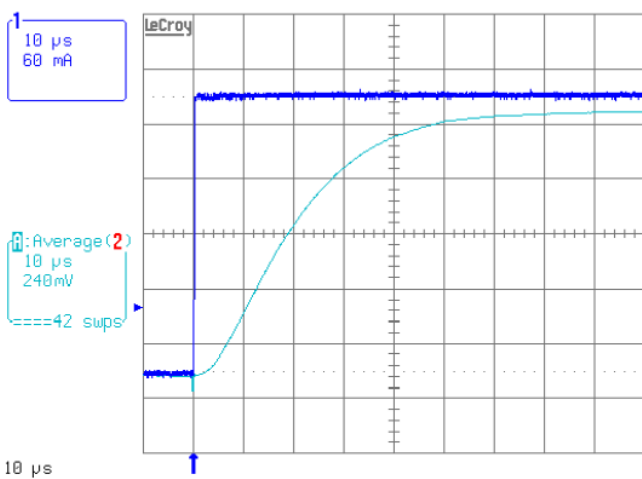

Figure 4: Typical step response

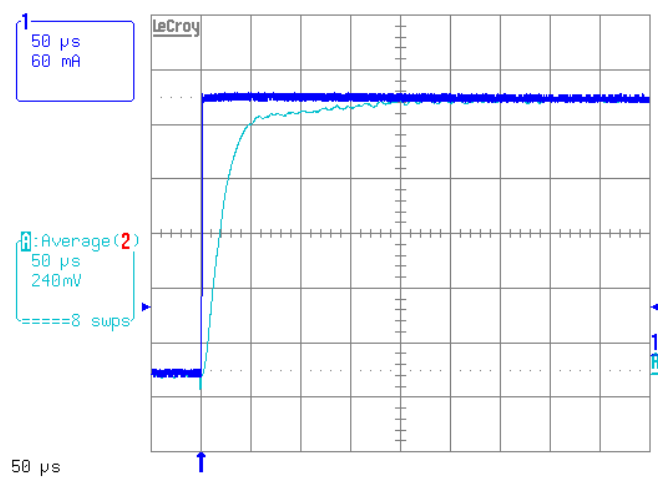

Figure 5: Typical step response

Electrical data CTSR 0.6-P

 At $T_A = 25^\circ\text{C}$, $V_C = +5\text{ V}$, output voltage referred to V_{REF} unless otherwise noted.

Parameter	Symbol	Unit	Min	Typ	Max	Comment
Primary nominal residual current rms	I_{PRN}	mA		600		
Primary residual current, measuring range	I_{PRM}	mA	-850		850	
Supply voltage	V_C	V	4.75	5	5.25	
Current consumption	I_C	mA	16	17.5	21.6	+ I_p (mA)/ N_s With $N_s = 1000$ turns - $40^\circ\text{C} \dots 105^\circ\text{C}$
Reference voltage @ $I_p = 0$	V_{REF}	V	2.495	2.5	2.505	Internal reference
External reference voltage	V_{REF}	V	2.3		4	Internal resistance of V_{REF} input = $499\ \Omega$ Note 1
Electrical offset current referred to primary (Note 2)	I_{OE}	mA	-24	4.2	24	
Temperature coefficient of V_{OE} @ $I_p = 0$	TCV_{OE}	ppm/K		60	520	ppm/K of 2.5 V - $40^\circ\text{C} \dots 105^\circ\text{C}$
Theoretical sensitivity	G_{th}	V/A		2.476		
Sensitivity error (Note 2)	ϵ_G	%	-0.2	0.3	0.7	$R_L > 500\ \text{k}\Omega$
Temperature coefficient of G	TCG	ppm/K			100	- $40^\circ\text{C} \dots 105^\circ\text{C}$
Linearity error	ϵ_L	% of I_{PRM}		0.4	1.3	
Reaction time @ 10 % of I_{PRN}	t_{ra}	μs		5		$R_L > 500\ \text{k}\Omega$, $di/dt > 5\ \text{A}/\mu\text{s}$
Response time @ 90 % of I_{PRN}	t_r	μs		30		$R_L > 500\ \text{k}\Omega$, $di/dt > 5\ \text{A}/\mu\text{s}$
Frequency bandwidth (- 1 dB)	BW	kHz		9.5		$R_L > 500\ \text{k}\Omega$
Output voltage noise (1 Hz .. 10 kHz)	V_{no}	mV rms		4		$R_L > 500\ \text{k}\Omega$
Magnetic offset current referred to primary ($1000 \times I_{PRN}$)	I_{OM}	mA		17		
Accuracy (Note 3)	X	%			1.5	$= (\epsilon_G^2 + \epsilon_L^2)^{1/2}$
Output voltage referred to GND (during Degauss cycle)		V		0.3	0.5	Note 1
Output voltage referred to V_{REF} (Test current)		V	V_{OE}^+ 0.4	V_{OE}^+ 0.75	V_{OE}^+ 1.1	Note 1

Notes: 1) See "Application information" section.

2) Only with a primary nominal residual current, see paragraph "Primary nominal residual current and primary nominal current".

 3) Accuracy @ T_A and I_p : $X_{TA} = (X^2 + (TCG \cdot 100 \cdot (T_A - 25))^2 + (TCV_{OE} \cdot 2.5 \cdot (T_A - 25) / G_{th} \cdot 100 / I_p)^2)^{1/2}$

Typical performance characteristics CTSR 0.6-P

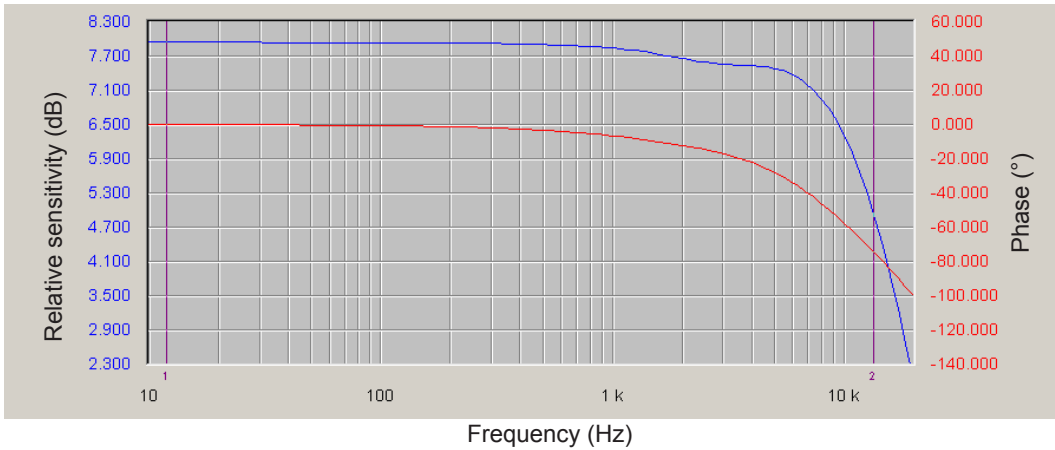

Figure 6: Frequency response

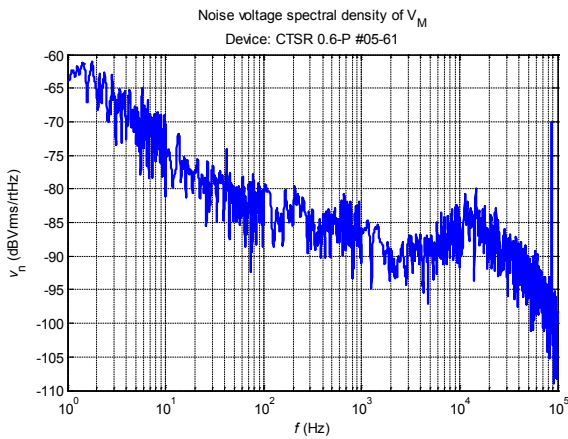

Figure 7: Output noise, spectral density

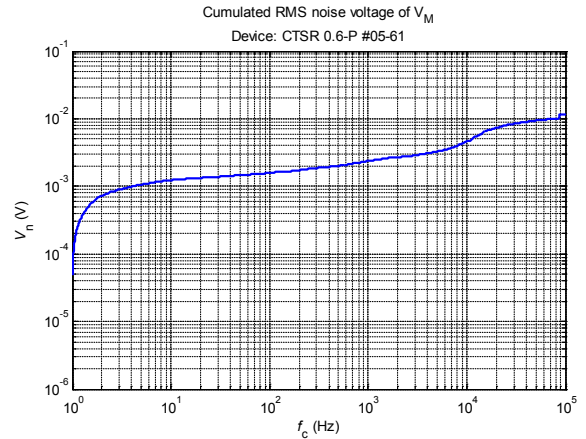

Figure 8: Output noise, cumulated rms

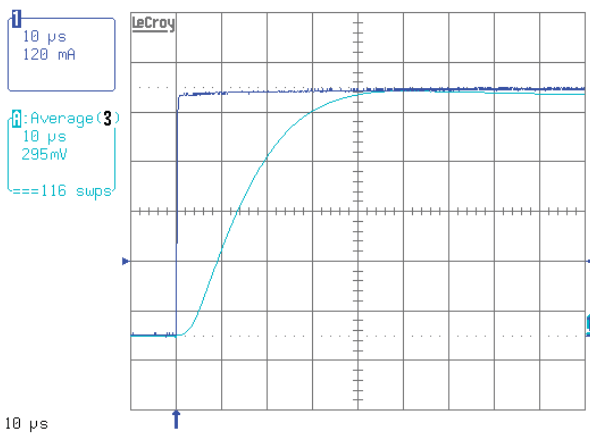

Figure 9: Typical step response

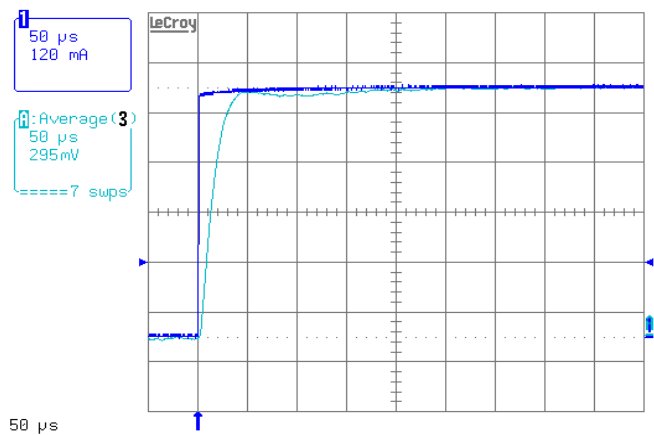

Figure 10: Typical step response

Application information

Filtering, decoupling CTSR transducer

Supply voltage Vc (5 V):

The CTSR transducers have internal decoupling capacitors, but in the case of a power supply track on the application PCB having a high impedance, it is advised to provide local decoupling, 100 nF or more, located close to the transducer.

Reference Vref:

Ripple present on the Vref pin can be filtered with a low value of capacitance because of the internal 499 ohm series resistance. The CTSR transducers have an internal capacitor of 22 nF between Vref pin and Gnd pin and the maximum filter capacitance value which could be added is 1 µF. Adding a larger decoupling capacitor will increase the activation delay of degauss.

Output Vout:

The CTSR transducers have an internal low pass filter 470 ohm/22 nF; if a decoupling capacitor is added on Vout pin, the bandwidth and the response time will be affected. In case of short circuit, the transducer CTSR can source or sink up to a maximum of 10 mA on its output Vout.

Using an external reference voltage

If the Vref pin of the transducer is not used it could be either left unconnected or filtered according to the previous paragraph "Reference Vref".

The Vref pin has two modes Ref Out and Ref In:

- In the Ref Out mode the 2.5 V internal precision reference is used by the transducer as the reference point for bipolar measurements; this internal reference is connected to the Vref pin of the transducer through a 499 ohms resistor. It tolerates sink or source currents up to ±5 mA, but the 499 ohms resistor prevents this current to exceed these limits.
- In the Ref In mode, an external reference voltage is connected to the Vref pin; this voltage is specified in the range 2.3 to 4 V and is directly used by the transducer as the reference point for measurements. The external reference voltage Vref must be able:
 - o either to source a typical current of $\frac{V_{ref} - 2.5}{499}$, the maximum value will be 3 mA when Vref = 4 V.
 - o or to sink a typical current of $\frac{2.5 - V_{ref}}{499}$, the maximum value will be 0.4 mA when Vref = 2.3 V.

The following graphs show how the measuring range of the transducer depends on the external reference voltage value Vref (Vc = 5 V).

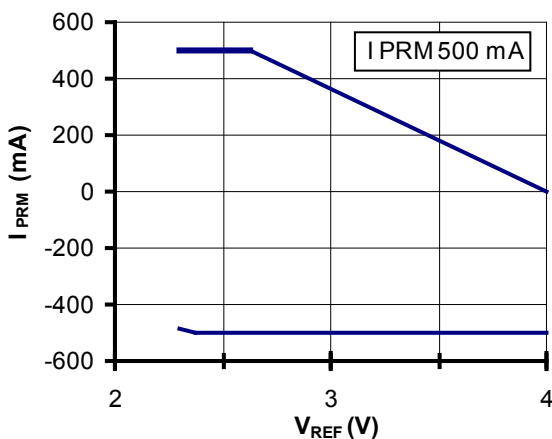

Upper limit: $I_p = 500 \text{ mA}$ (Vref = 2.3..2.625 V)
 Upper limit: $I_p = -363.5 \cdot V_{ref} + 1454.25$ (Vref = 2.625..4 V)
 Lower limit: $I_p = -210.6 \cdot V_{ref} + 0.092$ (Vref = 2.3..2.375 V)
 Lower limit: $I_p = -500 \text{ mA}$ (Vref = 2.375..4 V)

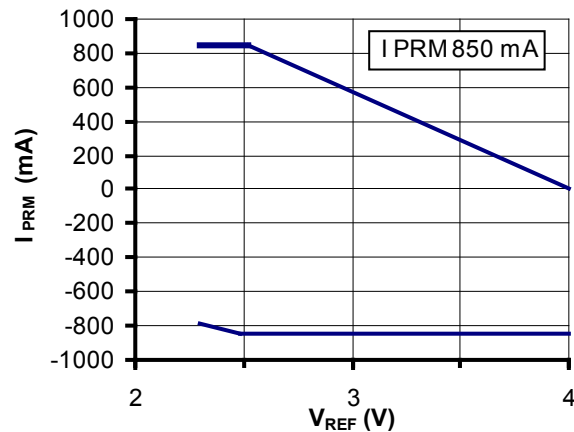

Upper limit: $I_p = 850 \text{ mA}$ (Vref = 2.3..2.52V)
 Upper limit: $I_p = -574.3 \cdot V_{ref} + 2297.5$ (Vref = 2.52..4 V)
 Lower limit: $I_p = -342.9 \cdot V_{ref} + 0.148$ (Vref = 2.3..2.48 V)
 Lower limit: $I_p = -850 \text{ mA}$ (Vref = 2.48..4 V)

Primary nominal residual current and primary nominal current

The primary nominal residual current is the sum of the instantaneous values of all currents flowing through the aperture of the transducer.

The primary nominal current is the current flowing through any conductor placed into the aperture of the transducer.

The presence of a primary nominal current DC or AC leads to an additional uncertainty.

For example, with a primary nominal current of 30 A the uncertainty referred to primary is 3.6 mA.

CTSR transducer in Test mode

When the **Vref** pin is forced at a Low level voltage between 0 and 1 V and is maintained at this level, the output voltage **Vout** of CTSR transducer exhibits a fixed value (see specification) as if it measured a primary test current.

The activation time of test mode is min 30 ms. The CTSR transducer can be maintained in test mode as long as needed for checking that it is fully operating.

CTSR transducer in Degauss mode

The CTSR transducers go in degauss mode automatically at each power on or on demand by using the **Vref** pin.

At power on:

A degauss is automatically generated at each power on of the CTSR transducer; during degaussing the output voltage **Vout** is maintained at 0.3 V typ. (max 0.5 V). After c.a. 110 ms, the output voltage **Vout** is released and takes the normal operation level in relation with the measured primary current.

Using Vref pin:

When the pin **Vref** is released from the Low level voltage defined in the Test mode above, there is a rising edge on **Vref** which generates an automatic degauss.

The activation of degauss takes typically 40 μ s after releasing **Vref** pin, then degauss lasts typically 110 ms.

Isolation around the CTSR transducer housing

Due to the joint between the case and the cover of the CTSR transducer, there is some isolation distance to respect when primary conductors pass around the CTSR housing.

The figure below shows the joint and the apertures where the clearance between the secondary part inside the CTSR transducer and the surface of the housing is 3 mm (label E).

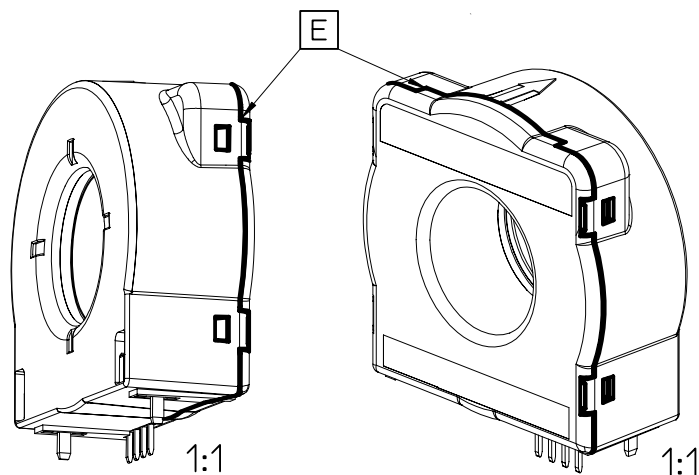

PCB Footprint CTSR series

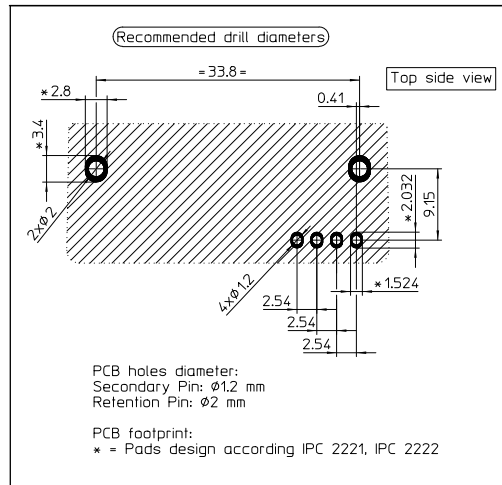

Assembly on PCB

- Recommended PCB hole diameter
 1.2 mm for secondary pin
 2 mm for retention pin
- Maximum PCB thickness
 2.4 mm
- Wave soldering profile
 maximum 260 °C, 10 s
 No clean process only

The two retention pins inserted into the case of the transducer are electrically isolated by the housing. Because one of them is close to the secondary connector, it is recommended to connect both to the secondary side GND or +Vc. Consequently any primary conductor must be placed in the PCB at the requested isolation distance regarding these secondary sides (see also paragraph "Isolation around the CTSR transducer housing").

Safety

This transducer must be used in limited-energy secondary circuits according to IEC 61010-1.



This transducer must be used in electric/electronic equipment with respect to applicable standards and safety requirements in accordance with the manufacturer's operating instructions.



Caution, risk of electrical shock.

When operating the transducer, certain parts of the module can carry hazardous voltage (e.g. primary bus bar, power supply). Ignoring this warning can lead to injury and/or cause serious damage.

This transducer is a build-in device, whose conducting parts must be inaccessible after installation.

A protective housing or additional shield could be used.

Main supply must be able to be disconnected.

Dimensions CTSR series (in mm, general tolerance ± 0.3 mm)

