

Electromagnetic Inductive RFID System V700





V700 System Offers Enhanced Functionality and High-Performance to Revolutionize Product and Distribution Management in the Production Environment











- A long transmission distance and a wide transmission range allow position displacement and axial offset of ID Tags to be handled easily.
- Reading and writing are possible with several ID Tags in the Antenna's transmission range for use in a wider range of new applications.
- Easy-to-use, reasonably-priced ID Tags mean low-cost systems, even in applications using a large number of Tags.
- A Compact Reader/Writer, the V700-HMD11(-1), is now available.
- The lineup includes an ID Link Unit that is compatible with multi-drop connections and RS-485 interfaces.
- The V700-HMD11-1 Compact Reader/Writer can be connected directly to the ID Link Unit or to an Omron PLC, without an AC Adapter.



Ordering Information



■ List of Models

Item	Description		Model
ID Tag	20 dia. × 2.7 mm	Coin-shaped 128 bytes (with user area of 112 bytes)	 V700-D13P31
	3.9 dia. × 25 mm	Stick-shaped 256 bytes (with user area of 240 bytes)	 V700-D23P41
ID Tag Holder	Special holder for the V700-D13P31 (There is no ID Tag provided with the product.)		 V700-A80
Antenna	250 × 200 × 35 mm	100-mm cable	 V700-H01 (Standard Antenna)
	650 × 200 × 35 mm	100-mm cable	 V700-H02 (Wide-field Antenna)



Item	Description		Model	
Controller	90 × 65 × 75 mm	RS-232C interface 24 VDC, 1 channel for Antenna connection	 V700-CD1D-V3	
		RS-485 interface Maximum number of Controllers that can be connected: 31 24 VDC, 1 channel for Antenna connection	 V700-CD2D-V3	
Antenna Cable	2 m	Material: Vinyl chloride The connector is not waterproof.		V700-A40
	3 m			V700-A41
	5 m			V700-A42
	10 m			V700-A43
	20 m			V700-A44
	30 m			V700-A45
Compact Reader/Writer	40 × 53 × 23 mm	RS-232C interface 5 VDC supplied via AC Adapter 2-m cable	 V700-HMD11	
		RS-232C interface 5 VDC supplied via AC Adapter for V700-L12 and CPM2C PLCs	1-m cable	 V700-HMD11-1
			2-m cable	
4-m cable				
Compact Flash Type Reader/Writer	52 x 59 x 12 mm	Compact Flash Type 2 PDA interface; 3.3 VDC from internal battery	 V705-HMF01	
PCB Type Reader/Writer Modules	80 x 80 x 5 mm	C-MOS interface	 V700-HMC71	
	40 x 44 x 10 mm	C-MOS interface	 V700-HMC73	
ID Link Unit	110 × 65 × 64 mm	RS-232C and RS-485 interface Unit for multiple connections	 V700-L12	
Programming Console		Equipped with the following functions: Execution status monitor, set value display, transmission execution, transmission test, noise measurement, reading error contents	 C200H-PRO27-E	
Programming Console Connecting Cable	2 m	Cable for connecting the V700-CD□D-V□ and C200H-PRO27-E	 V700-P10	

Specifications



■ ID Tags

Item	Model	
	V700-D13P31 	V700-D23P41 
Memory capacity	112 bytes (user area)	240 bytes (user area)
Memory type	EEPROM	
Data backup time	10 years after data written	
Data writing times	100,000 times per address	
Ambient operating temperature (during transmission)	-20 to 70°C (with no icing)	-25 to 70°C (with no icing)
Ambient operating temperature (not during transmission)	-40 to 110°C (with no icing). Heat resistance: Constant high temperature: 180°C for 200 hours Thermal cycle: 25°C/180°C, 30 minutes, 200 cycles	-40 to 110°C (with no icing)
Ambient storage temperature	-40 to 110°C (with no icing)	
Ambient operating humidity	No restrictions	35% to 95% (with no condensation)
Degree of protection	IEC60529: IP68	IEC60529: IP67
Vibration resistance	10 to 2,000 Hz, 0.75-mm single amplitude, 150-m/s ² acceleration with 10 sweeps of 15 min each in X, Y, and Z directions	
Shock resistance	500-m/s ² acceleration 3 times each in X, Y, Z directions (18 times total)	
Material	PPS resin	Case: PBT resin; Filling: Epoxy resin
Weight	Approx. 2 g	Approx. 1 g

■ Controllers

Item	Model	
	V700-CD1D-V3 	V700-CD2D-V3 
Host interface	RS-232C	RS-485 (Up to 31 Controllers can be connected.)
Number of connectable Antennas	1	
Power supply voltage	24 VDC +10%/-15%	
Power consumption	20 W max.	
Insulation resistance	20 MΩ min. (at 100 VDC) between the power supply terminals and ground terminal, power supply terminals and I/O terminals, power supply terminals and case, I/O terminals and ground terminal, I/O terminals and case, and ground terminal and case	
Dielectric strength	500 VAC (50/60 Hz, 1 minute) between the above terminals (leakage current: 10 mA max.)	
Vibration resistance	10 to 150 Hz, 0.30-mm double amplitude with 4 sweeps of 8 min each in X, Y, and Z directions	
Shock resistance	200-m/s ² acceleration for 3 times each in X, Y, and Z directions (18 times in total)	
Ambient operating temperature	-10 to 55°C (with no icing)	
Ambient operating humidity	35% to 85% (with no condensation)	
Ambient storage temperature	-25 to 65°C (with no icing)	
Ambient storage humidity	35% to 95% (with no condensation)	
Degree of protection	IEC60529: IP30 (panel mounted)	
Ground	Ground at a resistance of less than 100 Ω. If grounding is not performed properly, transmission specifications may be adversely affected by the surrounding environment.	
Weight	Approx. 290 g	

■ Antennas

Item	Model	
	 V700-H01	 V700-H02
Oscillation frequency	125 kHz	
Insulation resistance	20 MΩ min. (at 500 VDC) between the cable terminals and the case	
Dielectric strength	1,000 VAC (50/60 Hz, 1 minute) between the cable terminals and the case (leakage current: 1 mA max.)	
Vibration resistance	10 to 150 Hz, 1.50-mm double amplitude with 2 sweeps of 8 min each in X, Y, and Z directions	
Shock resistance	300-m/s ² acceleration for 3 times each in X, Y, and Z directions (18 times in total)	
Ambient operating temperature	-20 to 55°C (with no icing)	
Ambient storage temperature	-35 to 65°C (with no icing)	
Ambient operating humidity	35% to 85% (with no condensation)	
Ambient storage humidity	35% to 95% (with no condensation)	
Degree of protection	IEC60529: IP40 (except connector)	
Material	Case: PC/ASA resin; Rear panel: Phenol resin; PVC (The connector is not resistant to water or oil.)	
Cable length	Maximum connection distance: 50.1 m using extension cable.	
Weight	Approx. 800 g	Approx. 1,760 g

■ Compact Reader/Writers

Item	Model	
	 V700-HDM11	 V700-HMD11-1 (requires V700-L12)
Host interface	RS-232C	
Power consumption	5 VDC ±5% (supplied via V600-A20 AC Adapter) Oscillating: 200 mA max.; Not oscillating: 25 mA max.	5 VDC ±5% (supplied via connector) 250 mA max.
Insulation resistance	50 MΩ min. (at 500 VDC) between the cable terminals and the case	
Dielectric strength	1,000 VAC (50/60 Hz, 1 minute) between the cable terminals and the case (leakage current: 1 mA max.)	
Vibration resistance	10 to 150 Hz, 1.50-mm double amplitude with 4 sweeps of 8 min each in X, Y, and Z directions	
Shock resistance	300-m/s ² acceleration for 3 times each in X, Y, and Z directions (18 times in total)	
Ambient operating temperature	-10 to 55°C (with no icing)	
Ambient operating humidity	25% to 85% (with no condensation)	
Ambient storage temperature	-25 to 65°C (with no icing)	
Ambient storage humidity	25% to 95% (with no condensation)	
Degree of protection	IEC60529: IP67 The connector is not resistant to water or oil.	
Material	Case: ABS resin; Filling: Epoxy resin; Cable: PVC (oil-resistant)	
Cable length	2 m (RS-232C signal lines can be extended up to a total length of 15 m.)	1, 2, 4 m
Weight	Approx. 210 g	Approx. 210 g (2 m)

■ ID Link Unit

Item	V700-L12 
Host interface	RS-232C or RS-485 (special 1:N protocol)
Number of connectable Antennas	1
Power supply voltage	24 VDC +10%/–15%
Power consumption	10 W max.
Insulation resistance	50 MΩ min. (at 500 VDC) between the power supply terminals and the ground terminal
Dielectric strength	1,000 VAC (50/60 Hz, 1 minute) between the power supply terminals and the ground terminal (leakage current: 5 mA max.)
Vibration resistance	10 to 150 Hz, 0.20-mm double amplitude, 15-m/s ² acceleration with 10 sweeps of 8 min each in X, Y, and Z directions
Shock resistance	150-m/s ² acceleration for 3 times each in X, Y, and Z directions (18 times in total)
Ambient operating temperature	0 to 40°C (with no icing)
Ambient operating humidity	35% to 85% (with no condensation)
Ambient storage temperature	–15 to 50°C (with no icing)
Ambient storage humidity	35% to 85% (with no condensation)
Degree of protection	IEC60529: IP20
Ground	Ground at a resistance of less than 100 Ω. If grounding is not performed properly, transmission specifications may be adversely affected by the surrounding environment.
Weight	Approx. 185 g

■ ID Tag Holder (for V700-D13P31 Coin-Shaped ID Tag)

Item	V700-A80 
Ambient storage temperature	Conforms to the specifications for the V700-D13P31 Coin-shaped ID Tag.
Ambient operating humidity	No restrictions
Material	PPS resin
Weight	Approx. 5 g

■ Communications Distance (Reference Values)

Item	ID Tag	Communications distance
Using the V700-H01/H02	V700-D13P21	0 to 250 mm
	V700-D13P31	
	V700-D23P41	
Using the V700-H01/H02	V700-D13P21	8 to 43 mm
	V700-D13P31	
	V700-D23P41	
Using the V700-H01/H02	V700-D13P21	0 to 63 mm
	V700-D13P31	
	V700-D23P41	
Using the V700-H01/H02	V700-D13P21	0 to 53
	V700-D13P31	
	V700-D23P41	
Using the V700-H01/H02	V700-D13P21	0 to 45 mm
	V700-D13P31	
	V700-D23P41	
Using the V700-H01/H02	V700-D13P21	0 to 38
	V700-D13P31	
	V700-D23P41	

System Configuration

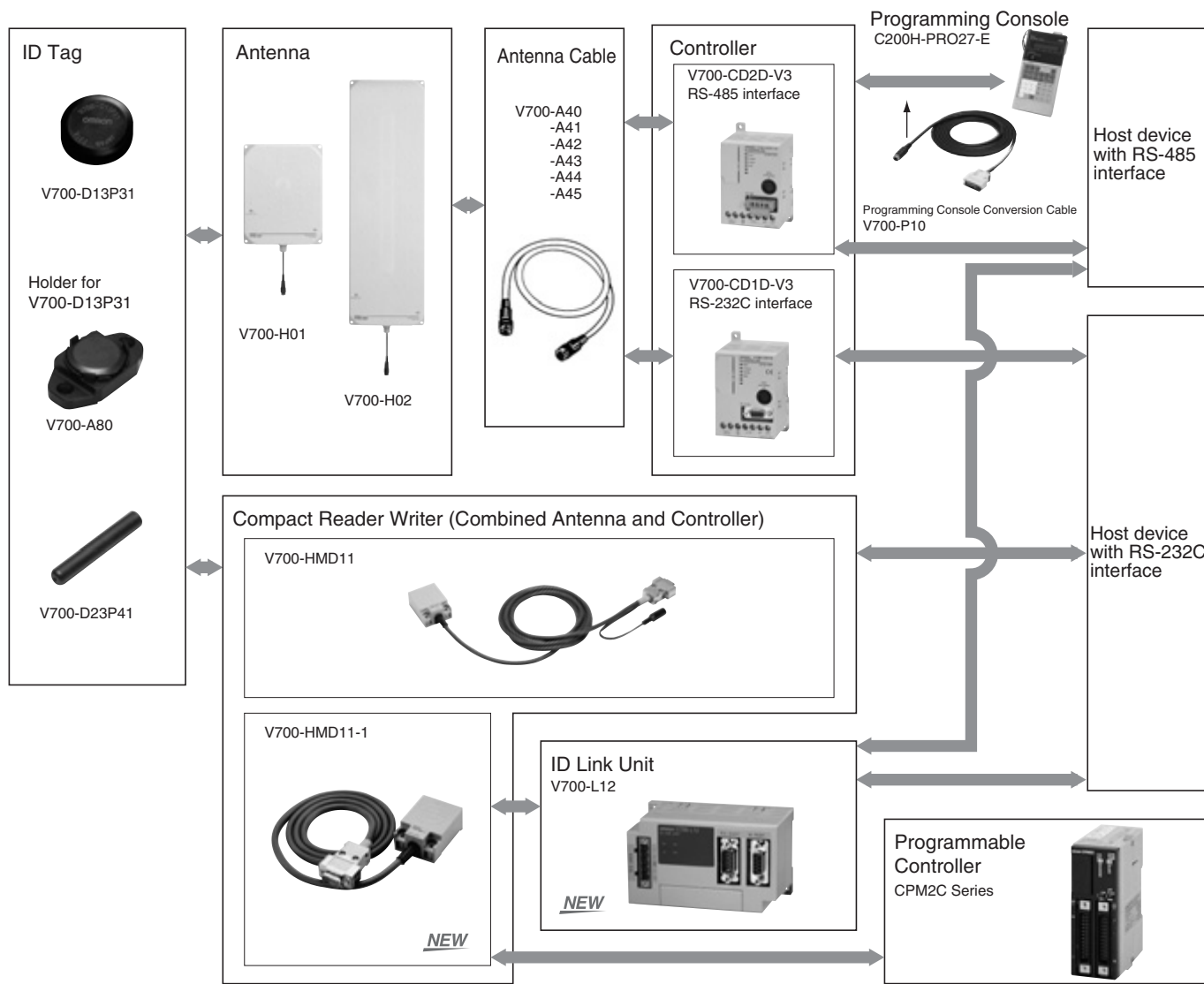

Note: The V700-CD1D-V3, V700-HMD11(-1), and V700-L12 all have different function and command structures.

Characteristic Data (Typical)

■ Transmission Range

Antenna Operation Range Graphs

V700-H01 & V700-D13P31

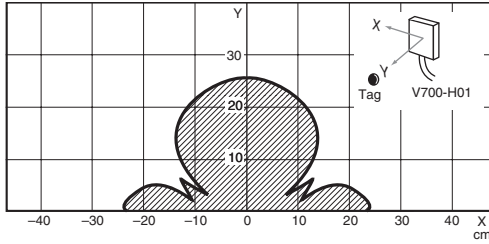

V700-H01 & V700-D23P41

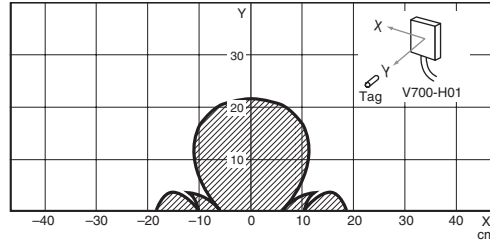

V700-H02 & V700-D13P31

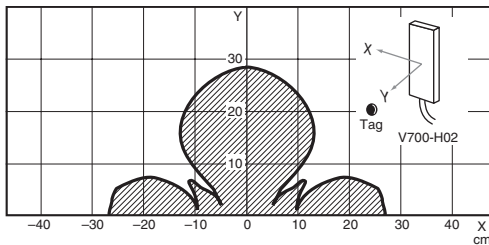

V700-H02 & V700-D23P41

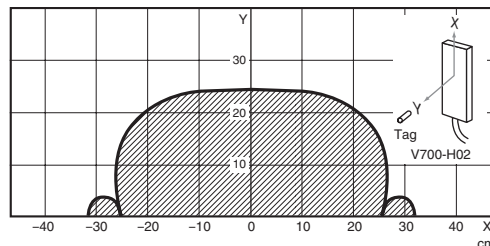
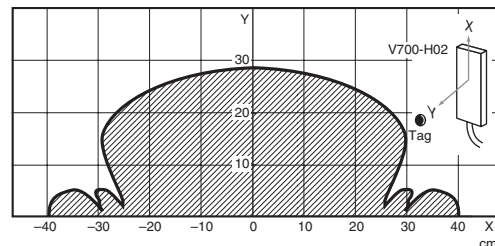
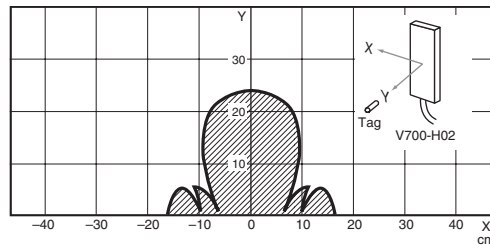

V700-HMD11(-1) & V700-D13P31

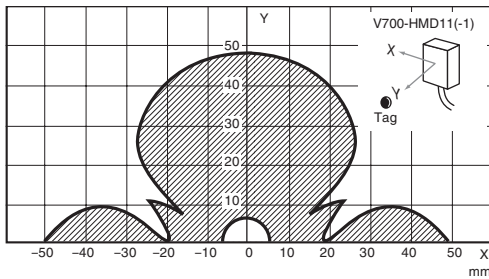

V700-HMD11(-1) & V700-D23P41

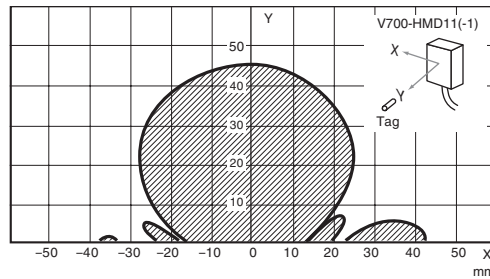

Transmission Time

The transmission time is the time required for transmission between the Antenna and ID Tag and does not include time required for host communications.

Note: T = Transmission time (ms)
N = Number of pages (1 page = 8 bytes)

V700-CD□D-V□

Asynchronous	Write	$T = 46.7 N + 60.7$
	Read	$T = 52.8 N + 113.5$
Read-only synchronization	Read	$T = 46.7 N + 107.4$
Read-write synchronization	Write	$T = 52.8 N + 119.6$
	Read	$T = 52.8 N + 172.4$

V700-HMD11/HMD11-1

Read	$T = 48 N + 66$
Write	$T = 55 N + 120$

Precautions on Using the Product Near Noise Sources

This product makes transmissions to ID Tags using a frequency of 125 KHz. Transceivers, motors, monitoring devices, and power supplies have parts that generate electromagnetic waves (noise). These waves may interfere with transmissions to ID Tags. Before using this product near these kinds of devices, check that there is no adverse affect on transmissions.

Multiple Access with the V700-□D-V□

The transmission time when using multiple-access commands not only depends on the number of bytes, but also on the number of ID Tags in the transmission range and the combination of the ID Tags' codes. The average values for random ID codes are given below.

Functions

Transmission Functions

	V700-CD1D-V3 V700-CD2D-V3	V700-HMD11 V700-HMD11-1
Single access	Provided	Provided
FIFO	Provided	Provided
Multiple access	Provided	Not provided
Selective access	Provided	Not provided

Note: The V700-CD□D-V□ and V700-HMD11(-1) have different command structures.

	ID Tag	Transmission distance
Using the V700-H01/H02	V700-D13P31	0 to 250 mm
	V700-D23P41	0 to 220 mm
Using the V700-HMD11 or V700-HMD11-1	V700-D13P31	8 to 43 mm
	V700-D23P41	0 to 37 mm

Note: The transmission distance is the same for reading and writing.

Mutual Interference Prevention Functions

If there is less than 15 m between Antennas, all the Antennas must be synchronized to prevent mutual interference. This can be done using either of the two methods described below.

Read-Only Synchronization

If all the Antennas only use read commands, this method can be used to reduce the access time.

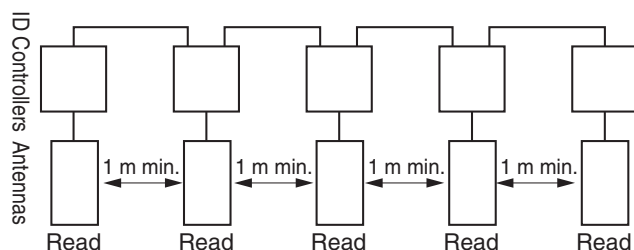

Read/Write Synchronization

This is the synchronization method that is usually used. It enables the synchronization of both read and write commands for several connected Antennas.

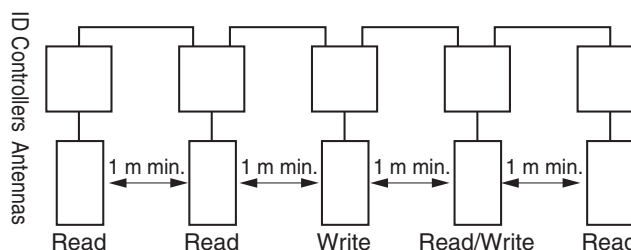

Dimensions

Note: All units are in millimeters unless otherwise indicated.

ID Tag

V700-D13P31
Coin-shaped ID Tag

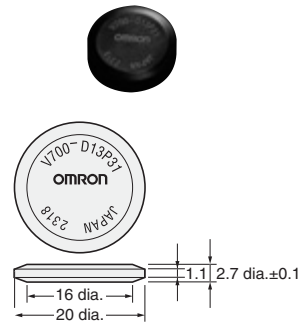

V700-D23P41
Stick-shaped ID Tag

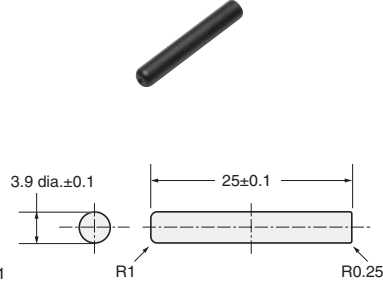

ID Tag Holder (for V700-D13P31)

V700-A80

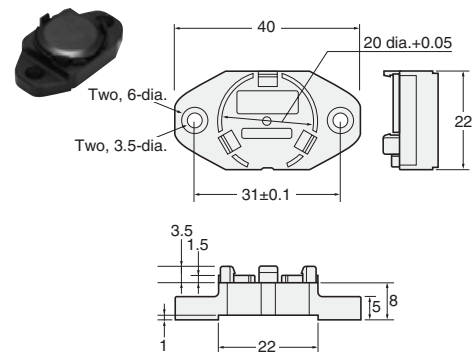

Antenna

V700-H01 Standard Antenna

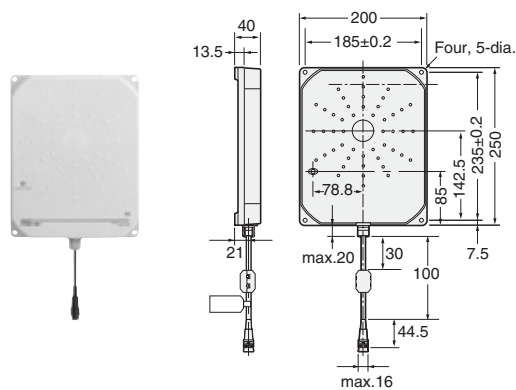

V700-H02 Wide-field Antenna

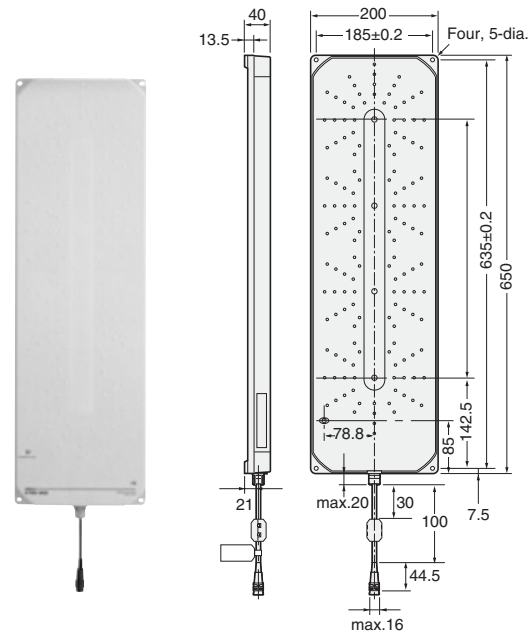

Compact Reader/Writer

V700-HMD11

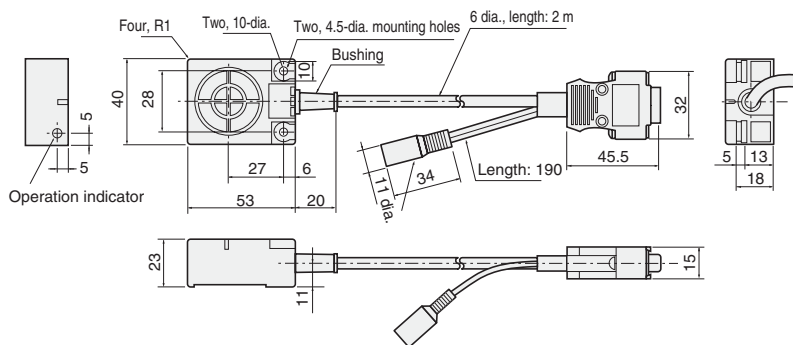

V700-HMD11-1

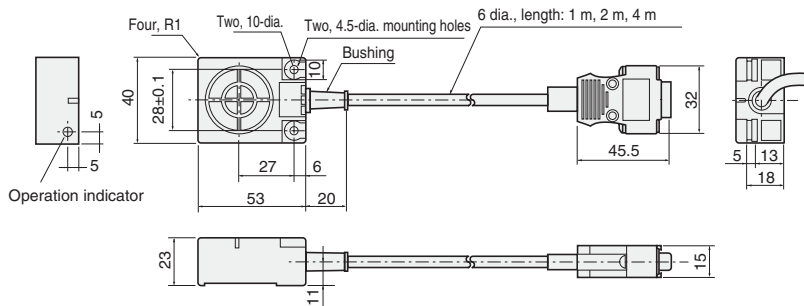

Controller

V700-CD1D-V3

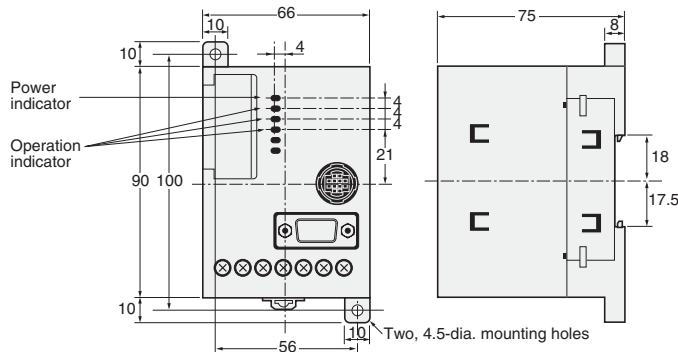

V700-CD2D-V3

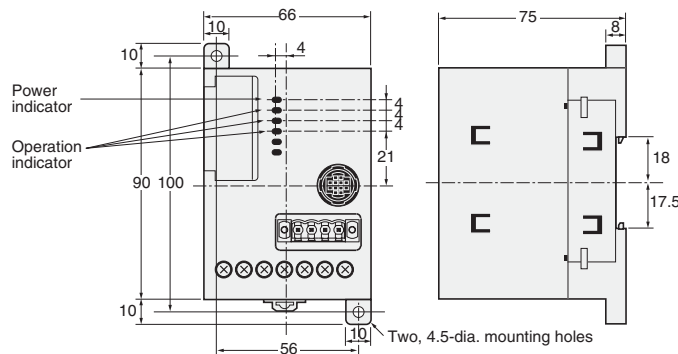

ID Link Unit

V700-L12

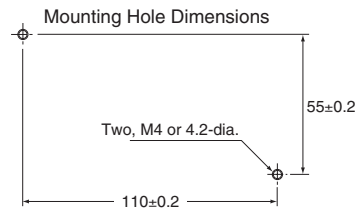
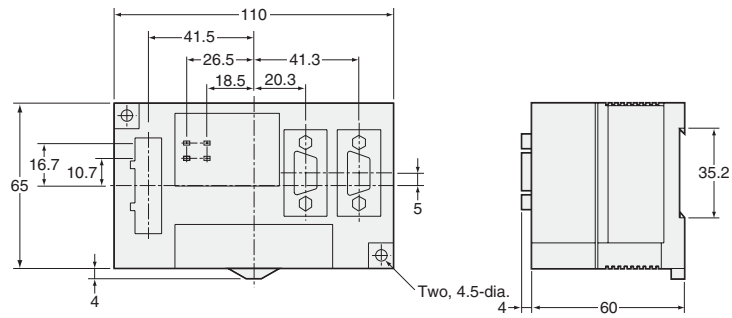

■ CF Card-Type RFID Unit V705-HMF01

- Omron's V705-HMF01 CF Card-type RFID Unit connects to a variety of PDAs (Personal Digital Assistants) to form a handy RFID Reader/Writer system. Its compact size ensures easy portability for use virtually anywhere.
- Supports original Omron Tags (V700-D13P21/31, V700-D23P41).
- Readily available PDA interface: Compact Flash Type 2 (<http://www.compactflash.org/>).
- Highly versatile functions, such as Read/Write modes, in a compact size.
- Combining the V705-HMF01 with a PDA costs much less than most handy RFID readers.



V705-HMF01 Product Specifications

Item	Specifications
Communications frequency	125 kHz
Ambient temperature in operation	0 to 50°C (with no icing)
Weight	Approx. 25 g
Supply voltage	3.3 VDC ± 5%
Antenna dimensions	50 (W) x 20 (H) x 13 (D) mm (the dimensions of the portion of the antenna extending from the PDA when the Unit is mounted in the PDA)
Current consumption	Approx. 90 mA (oscillating); approx. 70 mA (not oscillating)
Communications range	20 mm with V700-D13P31
Interface	Compact Flash Type 2 (9,600 bps)

Dimensions

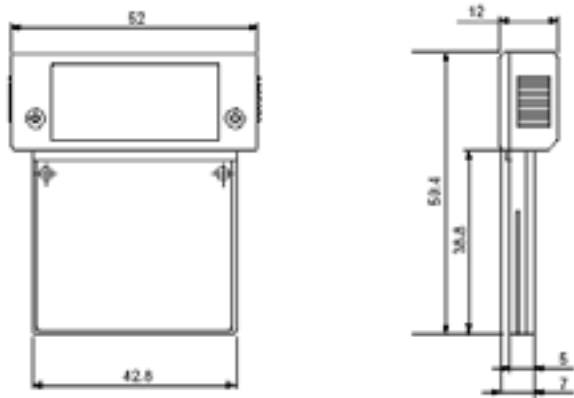

Communications Time Reference Value

Read	$T = 48 N + 66$
Write	$T = 55 N + 120$

Note: T = Transmission time (ms)
N = Number of pages (1 page = 8 bytes)

Communications Range

Tag V700-D13P31/21

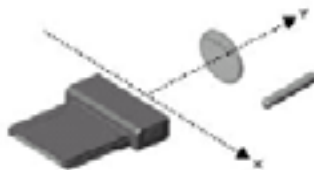
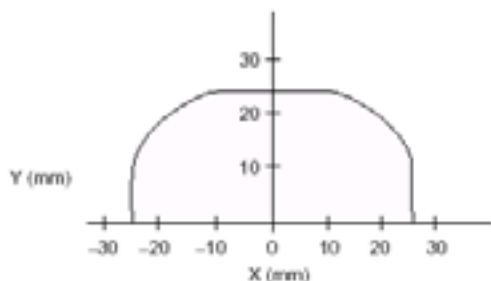

■ PCB-Type Reader/Writer Modules V700-HMC7□

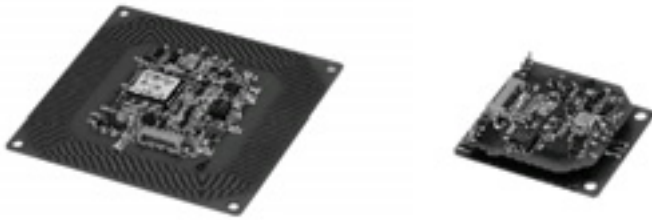

- These PCB-type Reader/Writer Modules are mounted to PCBs for incorporation into systems. A built-in C-MOS interface enables direct connection to the host CPU.
- The Modules offer industry-leading baud rate, as well as transmission distance and security specifications exceeding those of other products in the same class.

V700-HMC7□ Product Specifications

Item	V700-HMC71	V700-HMC73
Dimensions	80 x 80 x 5 mm	40 x 44 x 10 mm
Mounting	M3 screw mounting at 4 points	M2 or M2.3 screw mounting at 3 points
Supply voltage	5 VDC ±10%	
Current consumption	180 mA max. (oscillating), 15 mA max. (not oscillating)	
Vibration resistance	Destruction: 10 to 150 Hz, 0.15-mm single amplitude at 20 m/s ² in three directions 4 times for 8 minutes	
Shock resistance	Destruction: 200 m/s ² three times each in six directions	
Ambient temperature in operation	-10 to 55°C	
Ambient temperature in storage	-25 to 65°C	
Ambient humidity in operation	25% to 85% (with no condensation)	
Communications frequency	125 kHz	
Weight	Approx. 18 g	Approx. 11 g

Dimensions

V700-HMC71

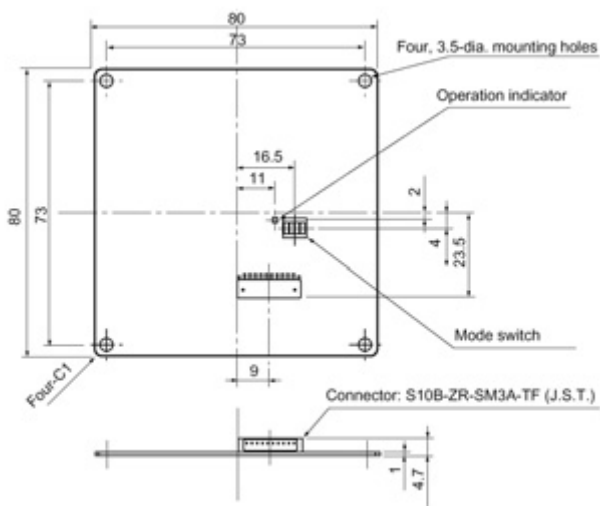

V700-HMC73

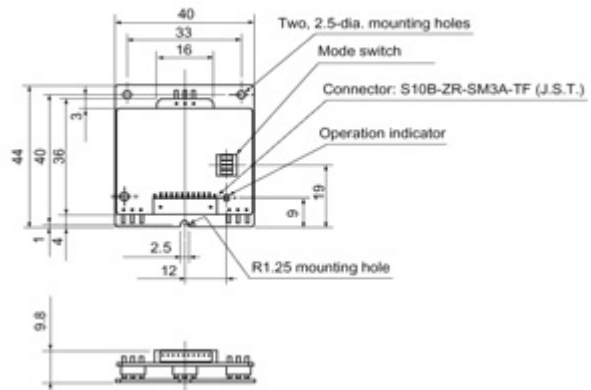

Antenna Operating Range

V700-HNMC71

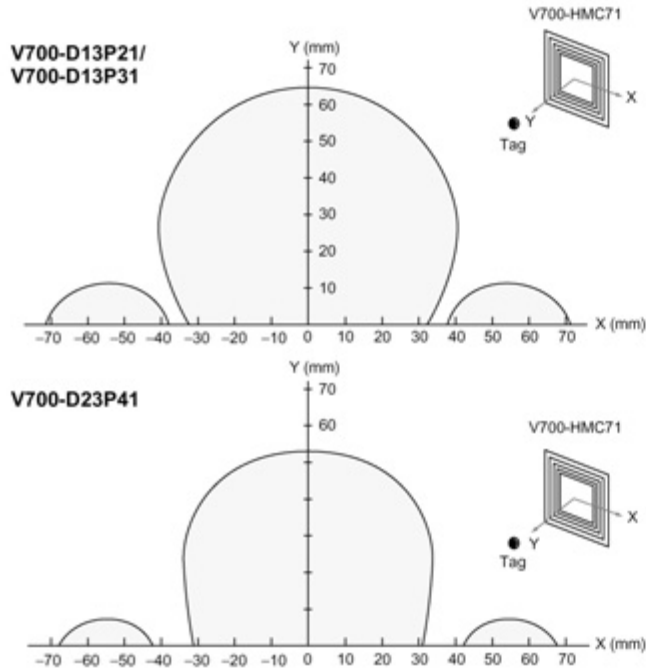

V700-HNMC73

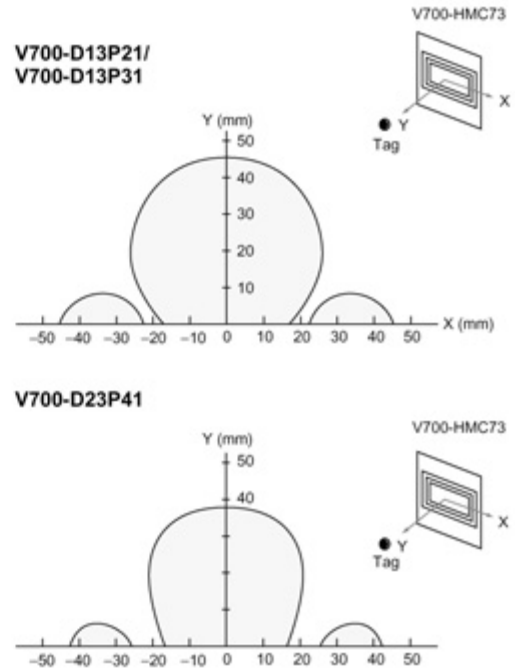

ALL DIMENSIONS SHOWN ARE IN MILLIMETERS.

To convert millimeters into inches, multiply by 0.03937. To convert grams into ounces, multiply by 0.03527.

Terms and Conditions

WARRANTY, LIMITATIONS OF LIABILITY

WARRANTY OMRON's exclusive warranty is that the products are free from defects in materials and workmanship for a period of one year (or other period if specified) from date of sale by OMRON.

OMRON MAKES NO WARRANTY OR REPRESENTATION, EXPRESS OR IMPLIED, REGARDING NON-INFRINGEMENT, MERCHANTABILITY OR FITNESS FOR PARTICULAR PURPOSE OF THE PRODUCTS. ANY BUYER OR USER ACKNOWLEDGES THAT IT ALONE HAS DETERMINED THAT THE PRODUCTS WILL SUITABLY MEET THE REQUIREMENTS OF THEIR INTENDED USE. OMRON DISCLAIMS ALL OTHER WARRANTIES, EXPRESS OR IMPLIED.

LIMITATIONS OF LIABILITY OMRON SHALL NOT BE RESPONSIBLE FOR SPECIAL, INDIRECT OR CONSEQUENTIAL DAMAGES, LOSS OF PROFITS OR COMMERCIAL LOSS IN ANY WAY CONNECTED WITH THE PRODUCTS, WHETHER SUCH CLAIM IS BASED ON CONTRACT, WARRANTY, NEGLIGENCE OR STRICT LIABILITY.

In no event shall responsibility of OMRON for any act exceed the individual price of the product on which liability is asserted.

IN NO EVENT SHALL OMRON BE RESPONSIBLE FOR WARRANTY, REPAIR OR OTHER CLAIMS REGARDING THE PRODUCTS UNLESS OMRON'S ANALYSIS CONFIRMS THAT THE PRODUCTS WERE PROPERLY HANDLED, STORED, INSTALLED AND MAINTAINED AND NOT SUBJECT TO CONTAMINATION, ABUSE, MISUSE, OR INAPPROPRIATE MODIFICATION OR REPAIR.

APPLICATION CONSIDERATIONS

SUITABILITY FOR USE OMRON shall not be responsible for conformity with any standards, codes or regulations which apply to the combination of the product in the customer's application or use of the product.

At the customer's request, OMRON will provide applicable third party certification documents identifying ratings and limitations of use which apply to the product. This information by itself is not sufficient for a complete determination of the suitability of the product in combination with the end product, machine, system, or other application or use.

The following are some examples of applications for which particular attention must be given. This is not intended to be an exhaustive list

of all possible uses of this product, nor is it intended to imply that the uses listed may be suitable for this product:

- Outdoor use, uses involving potential chemical contamination or electrical interference, or conditions or uses not described in this catalog.
- Nuclear energy control systems, combustion systems, railroad systems, aviation systems, medical equipment, amusement machines, vehicles, safety equipment, and installations subject to separate industry or government regulations.
- Systems, machines and equipment that could present a risk to life or property.

Please know and observe all prohibitions of use applicable to this product.

NEVER USE THE PRODUCT FOR AN APPLICATION INVOLVING SERIOUS RISK TO LIFE OR PROPERTY WITHOUT ENSURING THAT THE SYSTEM AS A WHOLE HAS BEEN DESIGNED TO ADDRESS THE RISKS, AND THAT THE OMRON PRODUCT IS PROPERLY RATED AND INSTALLED FOR THE INTENDED USE WITHIN THE OVERALL EQUIPMENT OR SYSTEM.

PROGRAMMABLE PRODUCTS OMRON shall not be responsible for the user's programming of a programmable product, or any consequence thereof.

DISCLAIMERS

PERFORMANCE DATA Performance data given in this catalog is provided as a guide for the user in determining suitability and does not constitute a warranty. It may represent the result of OMRON's test conditions, and the user must correlate it to actual application requirements. Actual performance is subject to the OMRON Warranty and Limitations of Liability.

CHANGE IN SPECIFICATIONS Product specifications and accessories may be changed at any time based on improvements and other reasons. It is our practice to change part numbers when published ratings or features are changed, or when significant construction changes are made. However, some specifications of the product may be changed without any notice. When in doubt, special part numbers may be assigned to fix or establish key specifications for your application. Please consult with your OMRON representative at any time to confirm actual specifications of purchased product.

ERRORS AND OMISSIONS The information in this catalog has been carefully checked and is believed to be accurate; however, no responsibility is assumed for clerical, typographical or proofreading errors, or omissions.

Complete terms and conditions for product purchase and use are on Omron's website at www.omron.com/oei – under the "About Us" tab, in the Legal Matters section.

ALL DIMENSIONS SHOWN ARE IN MILLIMETERS. To convert millimeters into inches, divide by 25.4

OMRON®

OMRON ELECTRONICS LLC

One Commerce Drive
Schaumburg, IL 60173

847-843-7900

For US technical support or other inquiries:

800-556-6766

OMRON CANADA, INC.

885 Milner Avenue
Toronto, Ontario M1B 5V8

416-286-6465

OMRON ON-LINE

Global - <http://www.omron.com>
USA - <http://www.omron.com/oei>
Canada - <http://www.omron.ca>