

RXM-SG GPS Module w/Ext Antenna (#28505)

The RXM-SG GPS Module provides a high quality, highly sensitive GPS receiver with an external antenna to provide a complete GPS solution for both microcontroller and PC applications. The high-performance SiRFstar III chipset features 20 parallel satellite tracking channels for fast acquisition of NMEA0183 data for robotics navigation, telemetry or experimentation. This GPS Module can connect to a microcontroller or even a PC (via USB). A Windows application provides a graphical display of the GPS data and can even show your location on Google Maps (internet connection required). Four general purpose I/O pins provide expansion for pin-intensive projects.

Features

- SiRFstar III chipset
- Outputs raw NMEA0183 data strings to microcontroller
- View data graphically on your PC via USB connection
- 200,000+ correlations
- Low power consumption
- High sensitivity (-159 dBm)
- 20 satellite tracking channels
- Battery-backed SRAM
- 11-pin SIP header with breadboard-friendly 0.1" spacing

Key Specifications

- Power Requirements: 5 V @ ~50 mA (typical)
- Communication: 3.3 V CMOS asynchronous serial @ 9600 baud default for microcontrollers, or USB for PC
- Dimensions: 1.7 x 1.6 x 0.6 in (4.33 x 4.09 x 1.52 cm)
- Operating temperature: -22 to +185 °F (-30 to +85 °C)

Application Ideas

- RoboMagellan robot competition
- Fleet Management
- Positioning and Navigation
- Surveying

Packing List

- RXM-SG GPS Module
- 2 shorting blocks (pre-installed)
- 1575.42 MHz external GPS antenna with 9' cable
- 3 V Lithium battery (CR2032)

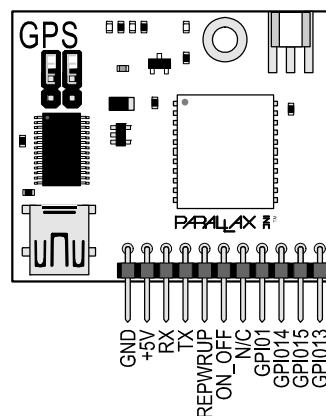
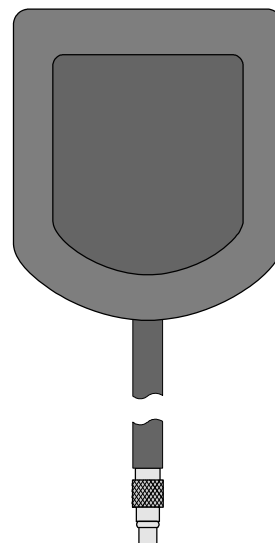

Quick-Start Guide

- ✓ Install the battery on the module: slide the battery under the clip on the back, from the top, ensuring that the + symbol faces away from the PCB.
- ✓ Connect the External GPS Antenna to its MMCX connector as shown in Figure 1.

For PC Connection via USB

- ✓ Install the USB drivers (required) and the LINX MDEV-GPS software (optional) from the links in the Resources and Downloads section on page 5.
- ✓ Make sure the jumper block is in the Shprted position, as shown Figure 3.
- ✓ Then, connect the GPS Module to your PC with a USB A to Mini B cable (not included) as shown in Figure 1. Your GPS module is now ready to use with the software of your choice via the USB port.

For Microcontrollers

- ✓ Make sure the jumper block is in the Open position, as shown in Figure 2.
- ✓ Connect the GPS module's GND pin to ground, and +5V pin to regulated 5 VDC.
- ✓ Minimum I/O connection is to connect the GPS module's TX pin to your microcontroller's available I/O pin set to input. Read the Communication Protocol section on page 3 before interfacing a 5 V microcontroller to the GPS module's RX or other input pins. For BASIC Stamp and Propeller microcontroller examples, see page 6.

Figure 1: Module Connections

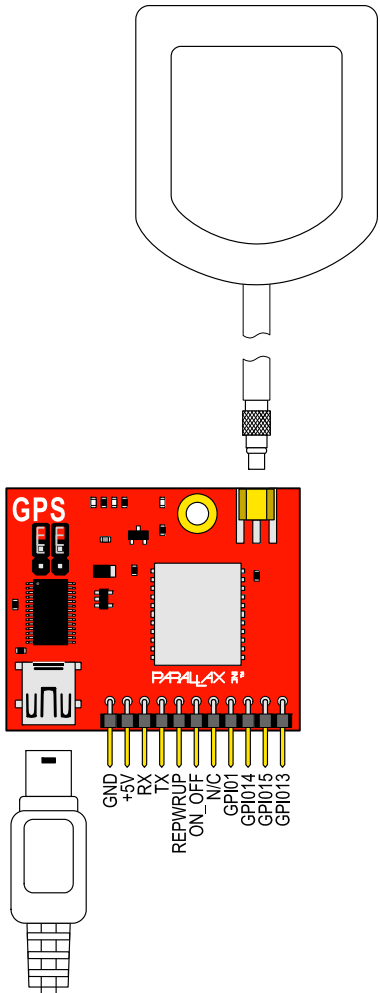

Figure 2: Jumpers Open—Microcontroller Mode

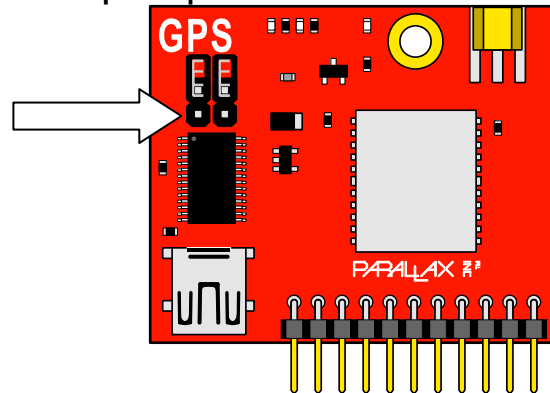
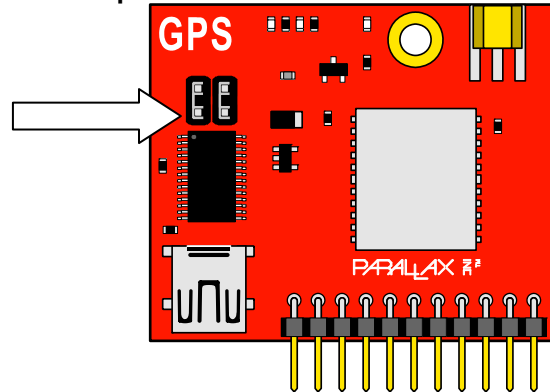

Figure 3: Jumpers Shorted—USB to PC Mode



Theory of Operation

Global Positioning System (GPS) is a space-based global navigation system providing location and time information anywhere on or near the earth. The system was created by the United States Department of Defense and consists of 24 satellites orbiting the earth. With an unobstructed view of the sky the GPS system will attempt to acquire and lock on to three or more satellites to provide a position fix using trilateration. Time information is provided by atomic clocks aboard each satellite. This information is provided to the user in UTC format.

Device Information

Supplying Power

The RXM-SG GPS module includes one 3 V lithium CR2031 battery. This battery is necessary for the module to operate. The purpose of the battery is to provide a backup power supply for the SRAM and RTC only; it is not sufficient on its own to power the module for operation. There are two power options:

- When using a PC connection via USB, the module draws power from the USB port for operation.
- When using a microcontroller connection, the module requires 50 mA of 5 V regulated DC voltage on its +5V pin (and a ground connection on GND).

CAUTION: Do not apply voltage to the module's +5 V pin while the module is connected to the PC via USB, as this could damage your computer's USB port.

Jumper Block

The purpose of the jumper block is to prevent write contention to the GPS module's TX and ON_OFF lines. The jumper block should always be in the Open position when used with a microcontroller, and in the Shorted position when used with a PC via USB. However, it is possible to receive data from the module by either method with the jumper block in either position.

LEDs

There are three surface-mount LEDs on the GPS module:

- Red (leftmost): Transmitting data to PC via USB
- Blue (center): Receiving data from PC via USB
- Green (rightmost): GPS channel lock status. This LED will blink rapidly while acquiring satellites signals until three channels have locked onto satellites. Once three channels are locked, the blinking will slow to a once-per-second rate.

Communication Protocol

Communication with the RXM-SG GPS Module is via non-inverted, 3.3 V CMOS level serial protocol at a default baud rate of 9600 bps. The baud rate can be set via command to 4800, 9600, 19200, 38400 or 57600 bps via the SetSerialPort command (see datasheet). Note that the GPS is compatible with 5 V microcontrollers from the perspective of the GPS output. Any signals going into the GPS module would need to be buffered using a level translator or buffer chip such as the 74LVC244A (Parallax #603-10004).

Command Set

The commands understood by the GPS Module are covered in detail in the RXM-GPS-SG datasheet. These commands are structured to look very much like the NMEA data the GPS provides. Note that each command must have a valid checksum at the end for the module to understand the command and process it. If you are unfamiliar with how the checksums are constructed please see the RXM-GPS-SG datasheet under the section, interfacing with NMEA messages.

Calibration

GPS calibration is not necessary as the GPS Module will download the necessary data from the available satellites automatically, however when the GPS Module is first powered up it must acquire ephemeral data from the satellites, which can take several minutes. Accuracy improves as more satellites are acquired, however civilian GPS resolution is around 20 yards (65 feet).

Please see the RXM-GPS-SG datasheet for additional information.

Pin Definitions

Pin	Name	Type	Function
1	GND	G	Ground (0 V)
2	+5V	P	Power (5 V)
3	RX	I	GPS Receive*
4	TX	O	GPS Transmit
5	RFPWRUP	O	Power State Indication
6	ON_OFF	I	Edge Triggered soft on/off request*
7	N/C	—	No Connection
8	GPIO01	I/O	General Purpose I/O*
9	GPIO14	I/O	General Purpose I/O*
10	GPIO15	I/O	General Purpose I/O*
11	GPIO13	I/O	General Purpose I/O*

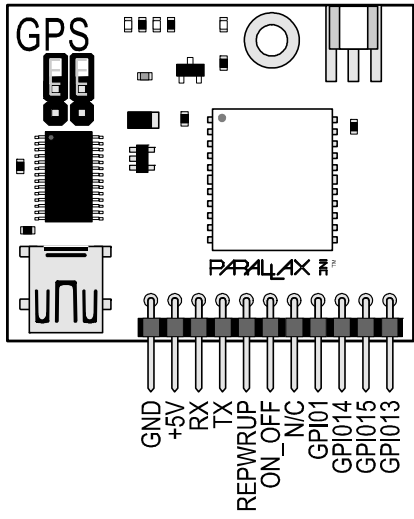

Pin Type: P = Power, G = Ground, I = Input, O = Output

*see RXM-GPS-SG datasheet for pin ratings and details

Precautions

- Always be sure to check the position of the jumpers when switching between Microcontroller and PC interfaces. The jumpers should be OPEN for Microcontrollers and CLOSED (shorted) for PC interfacing through a USB port.
- The I/O pins operate at a 3.3 V CMOS level and are not 5 V tolerant. Because of this, 5 V microcontrollers, such as the BASIC Stamp series, cannot send commands to the GPS Module directly, however they can receive NMEA data without issue. Any signals going into the GPS module would need to be buffered using a level translator or buffer chip such as the 74LVC244A (Parallax #603-10004).
- Do not connect the RXM-SG GPS Module to a USB port and external power at the same time.
- Do not connect the RX, TX, RFPWRUP or ON_OFF pins while interfacing to the USB port.

Module Dimensions

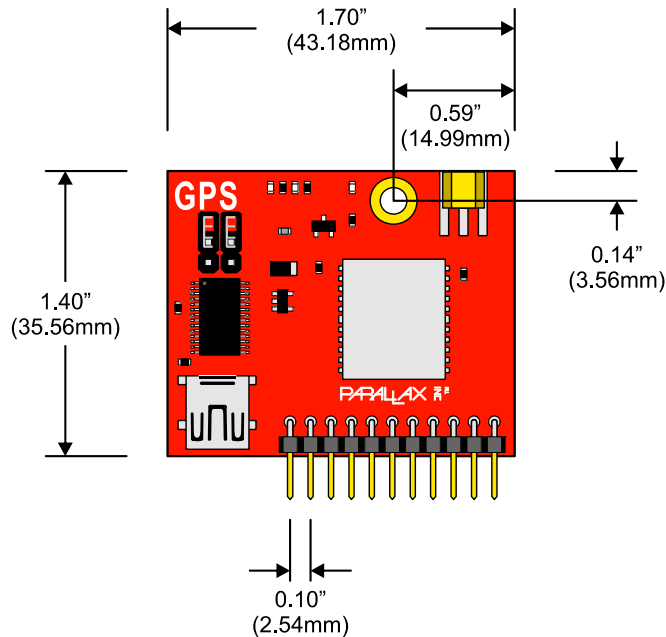

Resources and Downloads

Check for the latest version of this document, free software, and example programs from the RXM-GS GPS Module product page. Go to www.parallax.com and search 28505.

Product Page Resources

- Example code for the BASIC Stamp 2p.
- Linx Technology's GPS Module Evaluation software for Windows.
- RXM-GS GPS Module Schematic
- GPIO Command Set PDF

You may also visit <http://www.parallax.com/go/gps> for a GPS Module comparison chart.

USB Drivers

Before connecting this device to a PC you must first install the USB Drivers. Windows 2000/XP/Vista/7 drivers can be found at the following URL: <http://www.parallax.com/usbdriers>

If you wish to connect your GPS Module to a Mac or a PC running Linux you must obtain other drivers available at the following URL: <http://www.ftdichip.com/Drivers/VCP.htm>

Parallax Inc. cannot support installation or use of the GPS Module with drivers other than the Windows drivers posted on the Parallax website via the link above.

Propeller Example Code

The Propeller Object Exchange is a resource for Propeller objects created by Parallax Inc. as well as those submitted by other Propeller chip users. A search for GPS on the OBEX yields several available GPS objects which are free to download and use. You can visit the object exchange at the following URL: <http://obex.parallax.com/>

Microcontroller Examples

BASIC Stamp® 2p Series

A BASIC Stamp 2p, 2pe or 2px module is recommended for this product due to the large strings that need to be buffered. The BS2p series includes scratch pad RAM which can buffer an entire NMEA string for parsing into the various data elements required. Please view the steps below for connecting and testing your RXM-SG GPS Module using a BASIC Stamp 2p series module.

- ✓ Provide +5V power to the GPS Module. The GPS Module requires ~50 mA. If you're using a development board such as the Board of Education you can supply 5 V from Vdd. The on-board regulator of the BASIC Stamp module should not be used to power the GPS Module.
- ✓ Connect the TX (transmit) pin of the GPS Module to P0 of the BASIC Stamp 2p series module.
- ✓ Connect the GPS Antenna to the MMCX connector located on top of the GPS Module.
- ✓ Load (or enter) and run the test program, RXM-SG GPS Demo V1.0.bsp. The source code is available from the Downloads section of the RXM-SG GPS Module product page.
- ✓ Run (download) the code to the BASIC Stamp 2p series module. The Debug Terminal should open displaying the output of the program.

The display won't show all of the available data until at least three satellites have been acquired and locked.

Propeller™ Chip

As a 3.3 V multicore microcontroller, the Propeller chip can send commands to and receive data from the GPS Module simultaneously and without any signal voltage level management.

- ✓ Provide +5 V power to the GPS Module. The GPS Module requires ~50 mA. If you're using a development board such as the Propeller Demo Board or Prop Proto Board you can supply 5 V from the on-board 5 V regulator.
- ✓ Connect the TX (transmit) pin of the GPS Module to an available I/O pin on the Propeller chip.
- ✓ Connect the RX (receive) pin of the GPS Module to an available I/O pin on the Propeller chip.
- ✓ Connect any of the other optional pins from the GPS Module to available I/O pins on the Propeller chip.
- ✓ Connect the GPS Antenna to the MMCX connector located on top of the GPS Module.
- ✓ Example GPS objects can be downloaded from the Propeller Object Exchange. Please see the link in the Resources section on page 5 of this documentation.
- ✓ Always check the pin assignments to ensure the direction of the pins connected to the module.
- ✓ Run (download) the code to the Propeller chip.