



Specification

SPECIFICATION

Part No. : MA600.A301111.B305111.C305111

Product Name : Spartan screw-mount GPS / Cellular / 2.4GHz / 5GHz combination antenna

Feature : High performance outdoor antenna
Custom cables and connectors available
RoHS ✓



Version	Date	Revision Description	Prepared	Approved
A	Aug 25 th 2010	New Product	TW Product Centre	Zita Lin
B	Oct 1 st 2010	Mechanical Drawing	TW Product Centre	Zita Lin

© All Rights Reserved

Taoglas Limited, Unit 7 Peare Campus, Moyne Business Park, Old Dublin Road,
Enniscorthy, Co. Wexford, Ireland www.taoglas.com



I. Introduction

The Spartan MA.600 antenna is a heavy-duty, fully IP67 waterproof external M2M antenna for use in telematics, transportation and remote monitoring applications. The Spartan is unique in the market because it combines a 3in1 GPS, Cellular (2G and 3G) and Wi-Fi, heavy-duty antenna with high efficiency in a compact format. The antenna screws down permanently onto a roof or metal panel and can be pole or wall-mounted with a metal bracket.

For industries such as commercial vehicle telematics, remote monitoring, smart meter systems and construction equipment, the Spartan provides a robust, rugged antenna that is durable, even in extreme environments.

All while still maintaining 20dB isolation between antennas. It uses high-shielded PTFE dielectric ultra low-loss cables that maintain low attenuation at all frequency bands, with an average 0.3dB per meter (0.1dB per foot), compared to 0.7dB for RG58 and 1.2dB for RG174. Because of this, the Spartan maximizes chances of passing PTCRB and network approvals first time. The Spartan also has excellent GPS reception without need to attach to an external ground-plane due to coupling to its unique own metal base.



Specification

II. Specification

GPS					
Centre Frequency	1575.42MHz				
Bandwidth	10MHz				
Average Gain	32dBic typ.				
Radiation Efficiency	50%				
Gain @ Zenith	4.0dBic typ.				
Axial Ratio	3.0dB typ.				
Polarization	Right Hand Circular				
VSWR	<=1.9:1				
Impedance	50Ω				
DC Power Input Range	3 ~ 5V				
DC input	3.3V	4.0V	5.0V		
LNA Gain	35dB	31dB	32dB		
Noise Figure	1.5dB	1.55dB	1.62dB		
Power Consumption	8mA	10mA	13mA		
Band Attenuation	± 50MHz	± 70MHz	± 100MHz		
	40dB	40dB	50dB		
Cable	3m RG174 standard, fully customizable				
Connector	SMA(M) standard, standard, fully customizable				
CELLULAR					
Frequency (GHz)	824 ~ 896	880 ~ 960	1710 ~ 1880	1850 ~ 1990	1710 ~ 2170
Peak Gain (dBi)	2.1	-0.2	2.9	3.0	5.1
Average (dBi)	-4.7	-7.5	-2.7	-3.1	-3.1
Efficiency	35%	20%	51%	49%	49%
Impedance	50Ω				
Polarization	Linear				
Radiation Pattern	Omni				
Cable	3m CFD200 standard, fully customizable				
Connector	SMA(M) standard, fully customizable				
WIFI					
Frequency (GHz)	2.4 ~ 2.5	4.7 ~ 5.0	5.0 ~ 5.4	5.4 ~ 5.9	
Peak Gain (dBi)	2.1	2.9	3.8	2.8	
Average Gain (dBi)	-2.3	-3.6	-3.3	-3.8	
Efficiency	60%	44%	46%	42%	
VSWR	<=1.6:1				
Impedance	50Ω				

© All Rights Reserved

Taoglas Limited, Unit 7 Peare Campus, Moyne Business Park, Old Dublin Road,
Enniscorthy, Co. Wexford, Ireland www.taoglas.com



Specification

Polarization	Linear
Radiation Pattern	Omni
Cable	3m CFD200 standard, fully customizable
Connector	SMA(M) standard, standard, fully customizable
MECHANICAL	
Dimensions	Profile 39.5mm x Diameter 145.6mm
Casing	UV resistant PVC
Base and thread	Nickel Plated Zinc
Thread diameter	30mm
Waterproof	IP67
ENVIRONMENTAL	
Temperature Range	-40°C to 85°C
Humidity	Non-condensing 65°C 95% RH

* all measurements are done in free space with standard cables

III. GPS Antenna Characteristics

III.1. Return Loss

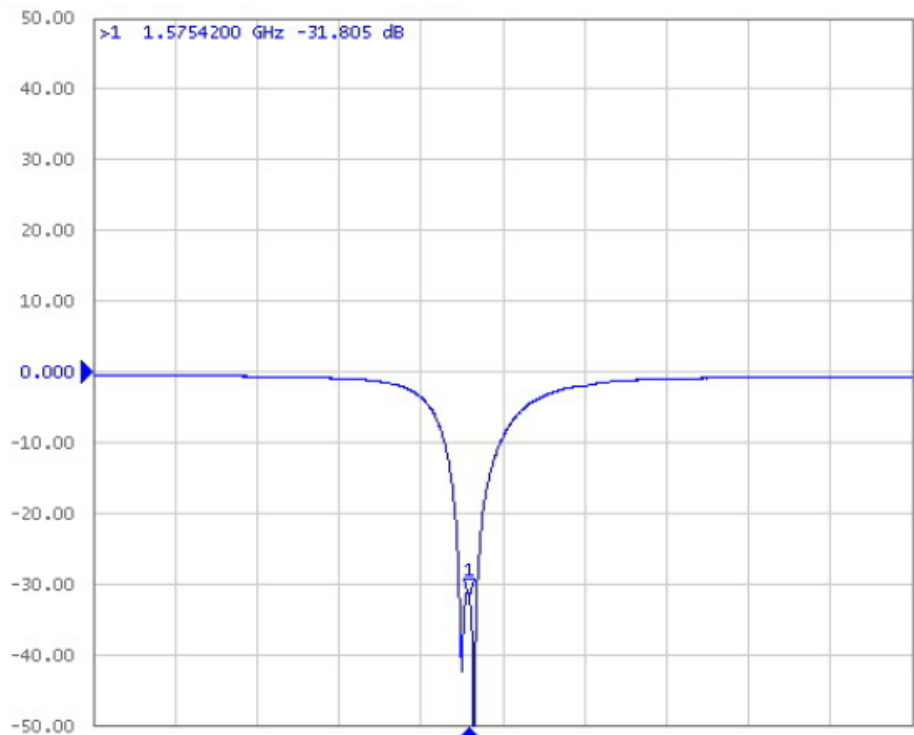



III.2. GPS Antenna Radiation Pattern

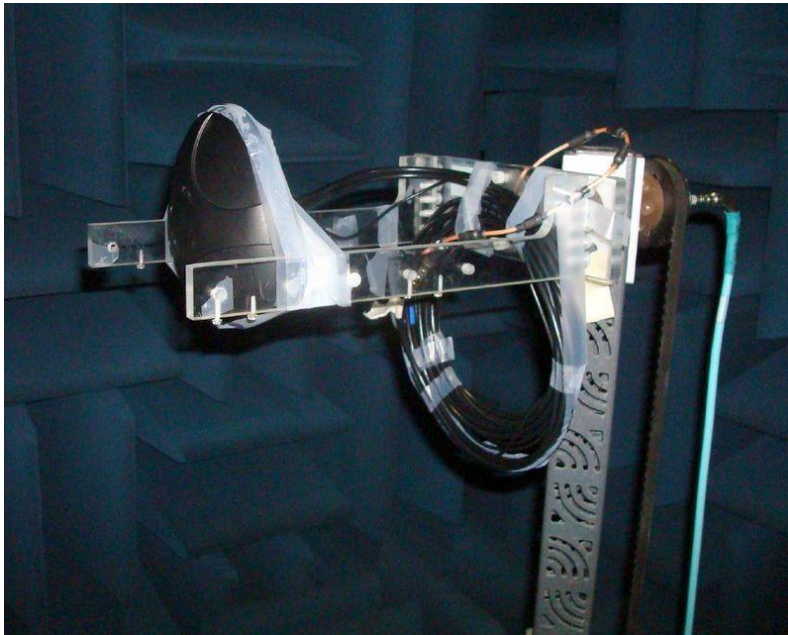

MA.600 tested in CTIA approved 3D chamber

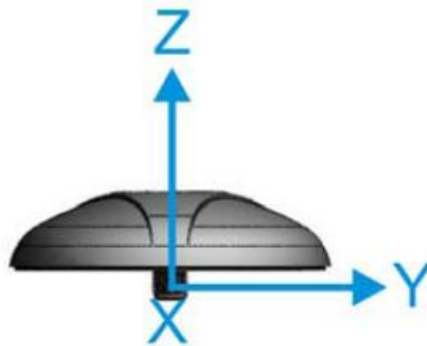

XYZ co-ordinate for reference.



Specification

XY-plane

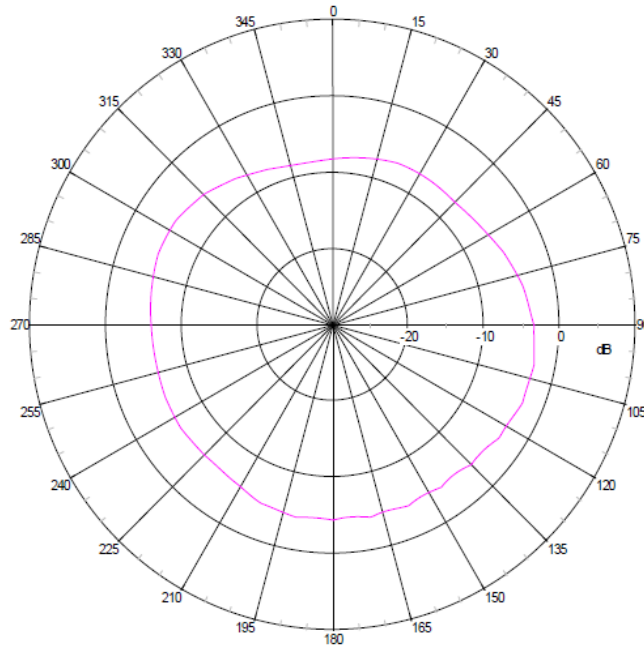

XZ Plane

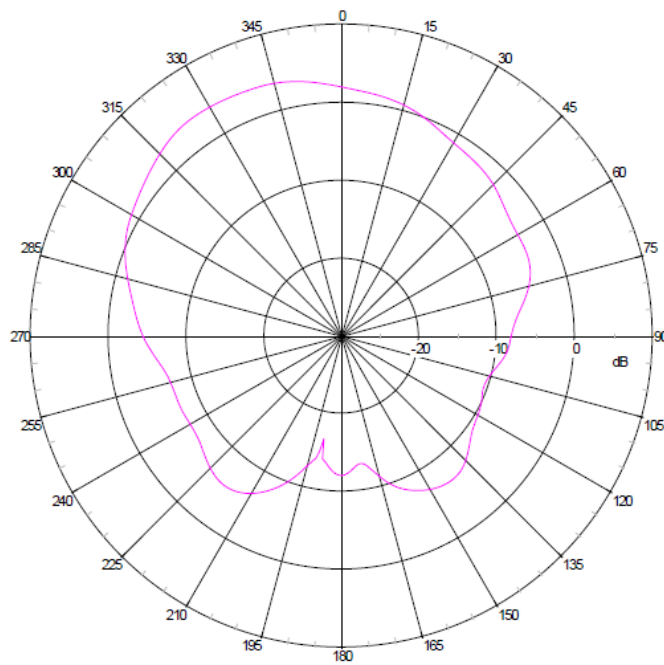



Specification

YZ Plane

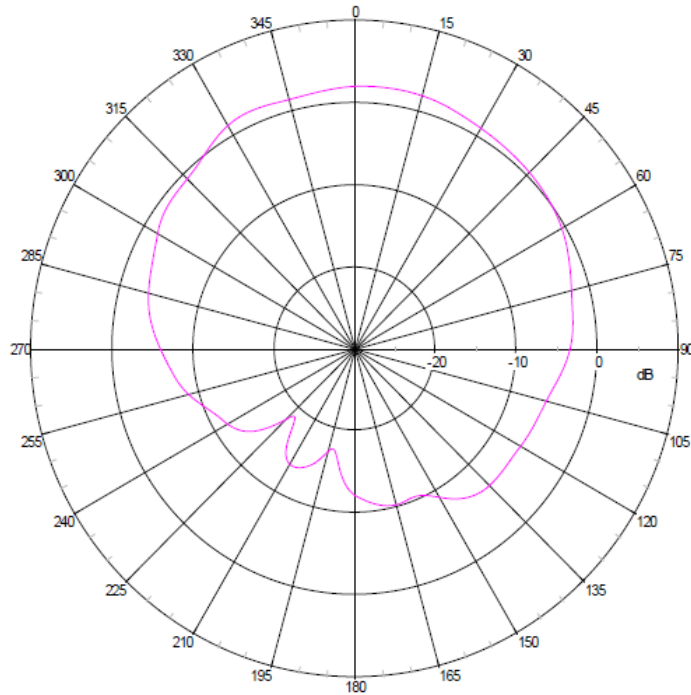

III.3. Axial Ratio

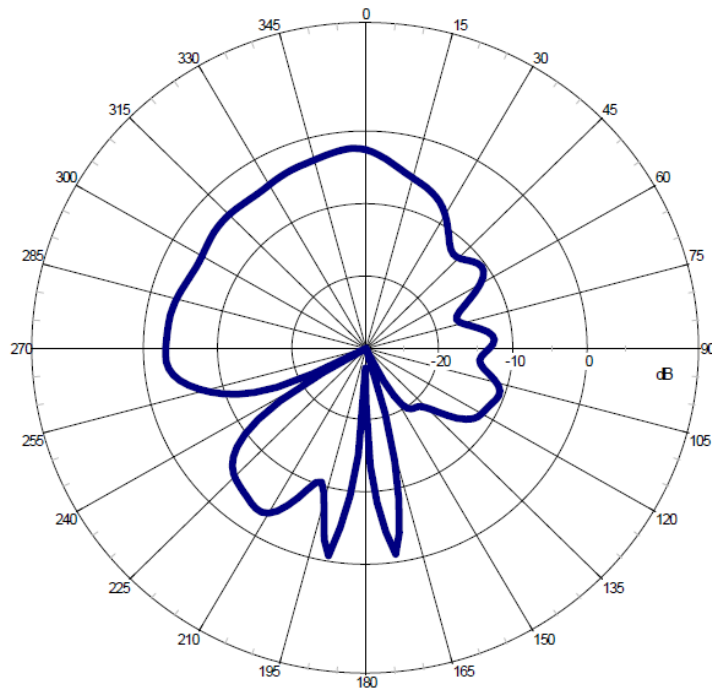



Specification

III.4. GPS LNA

Block Diagram

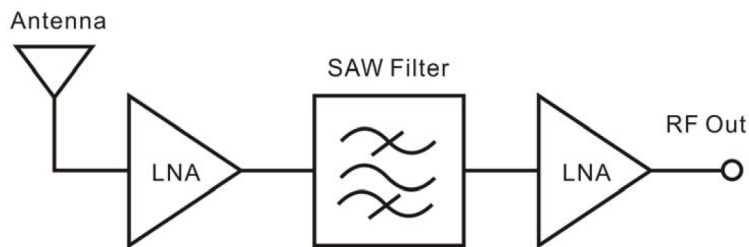

Forward Transmission

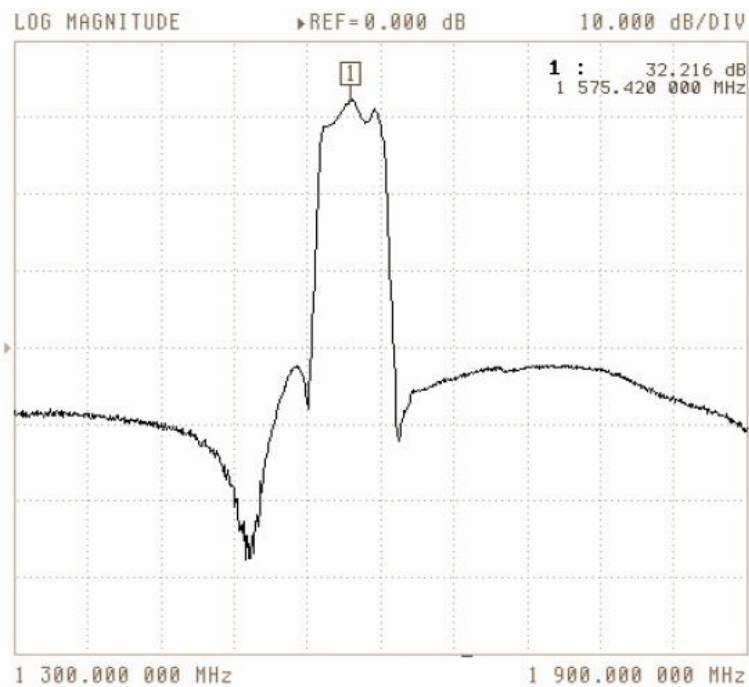



Specification

S22 Reverse Reflection

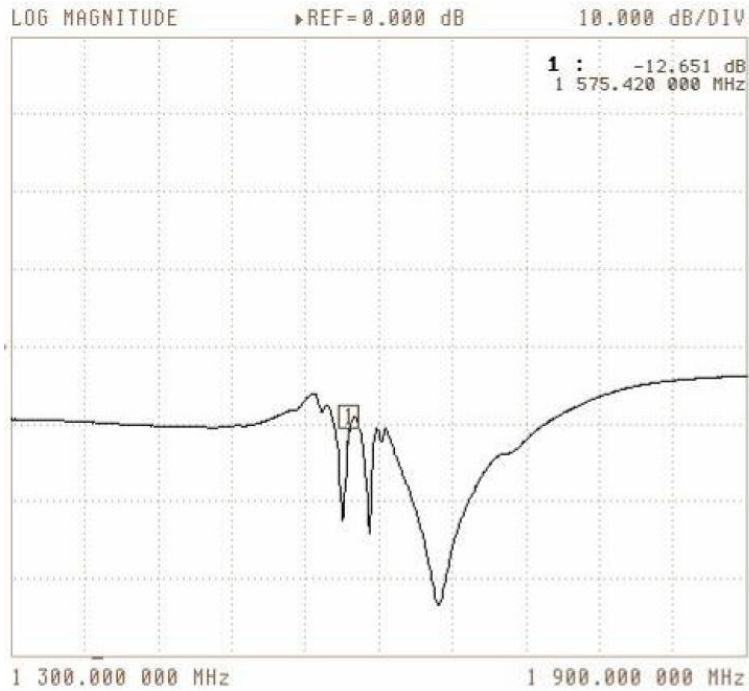



IV. Cellular Antenna Characteristics

IV.1. Return Loss

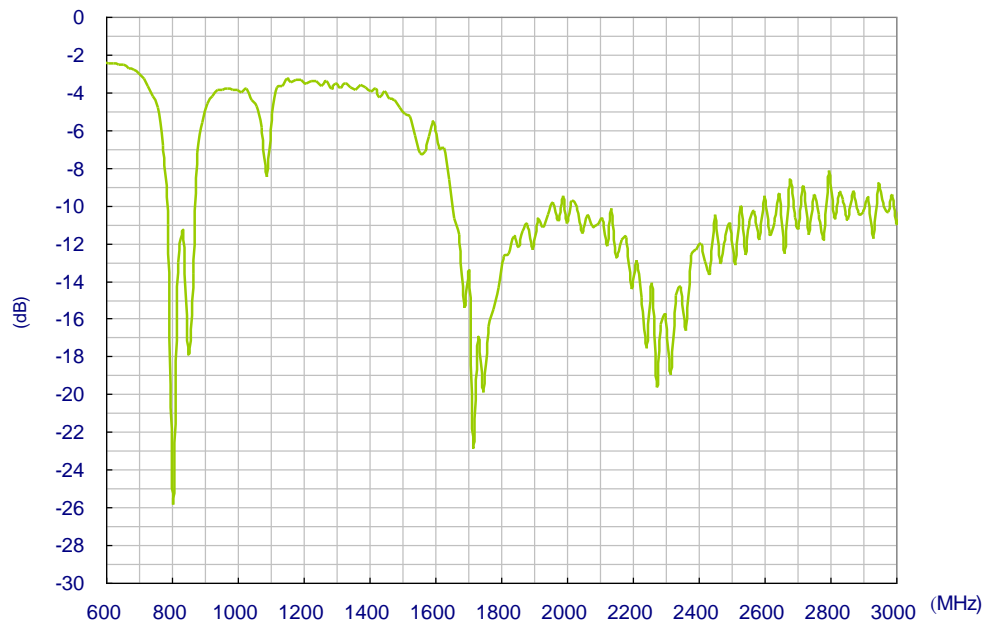

IV.2. VSWR

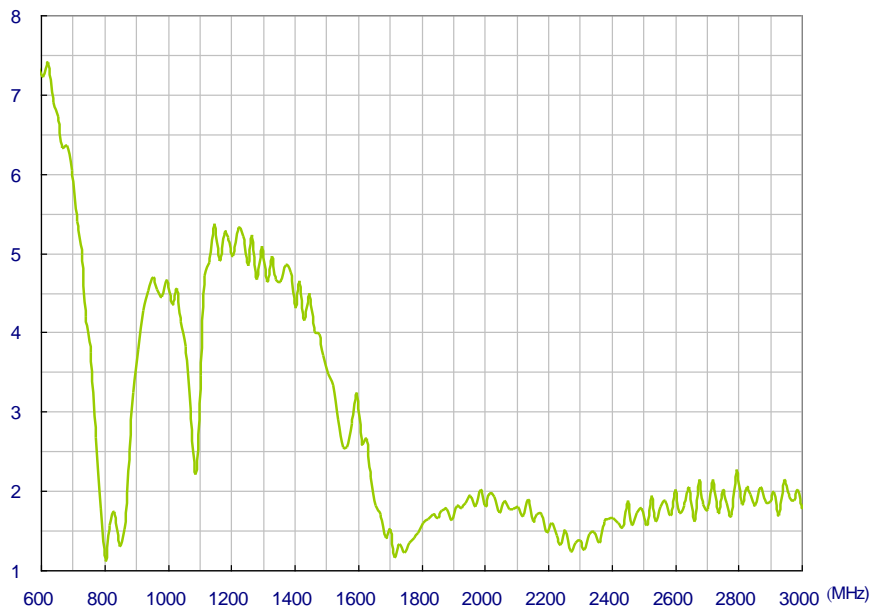



Specification

IV.3. Cellular Antenna Efficiency

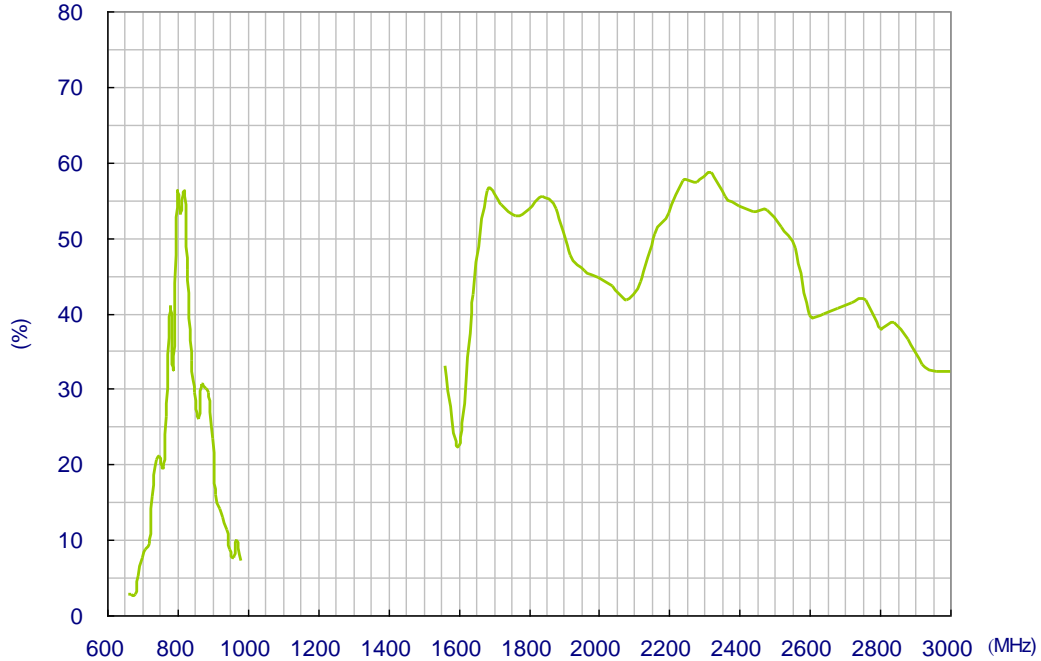

IV.4. Cellular Antenna Peak Gain

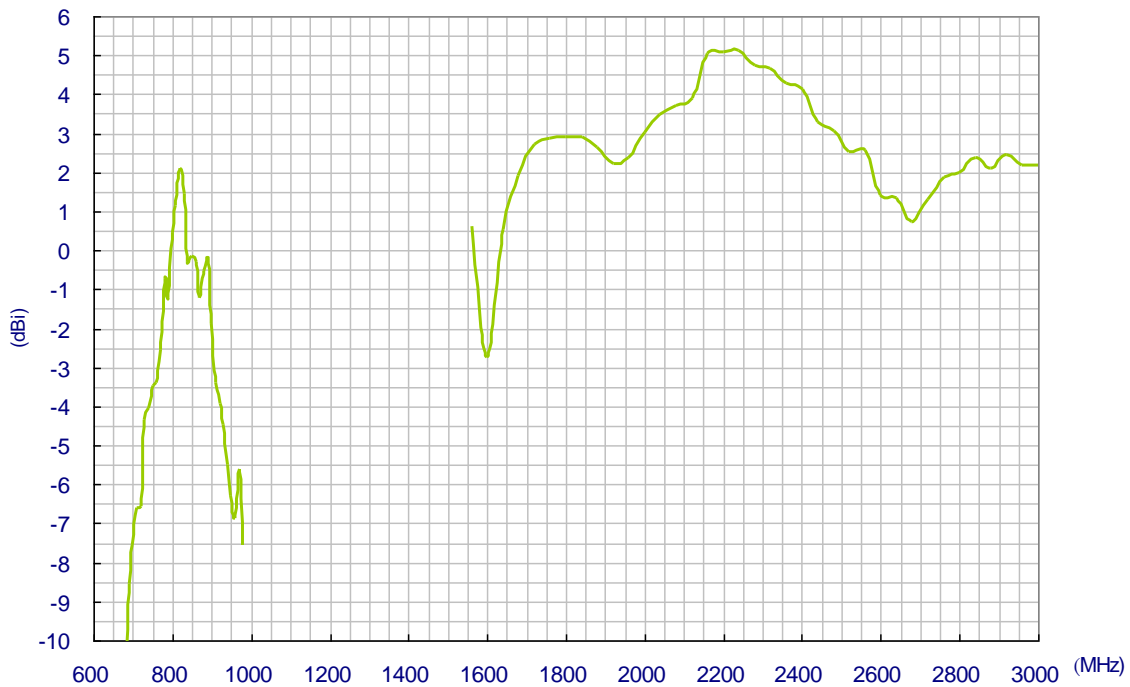



Specification

IV.5. Cellular Antenna 3D Average Gain

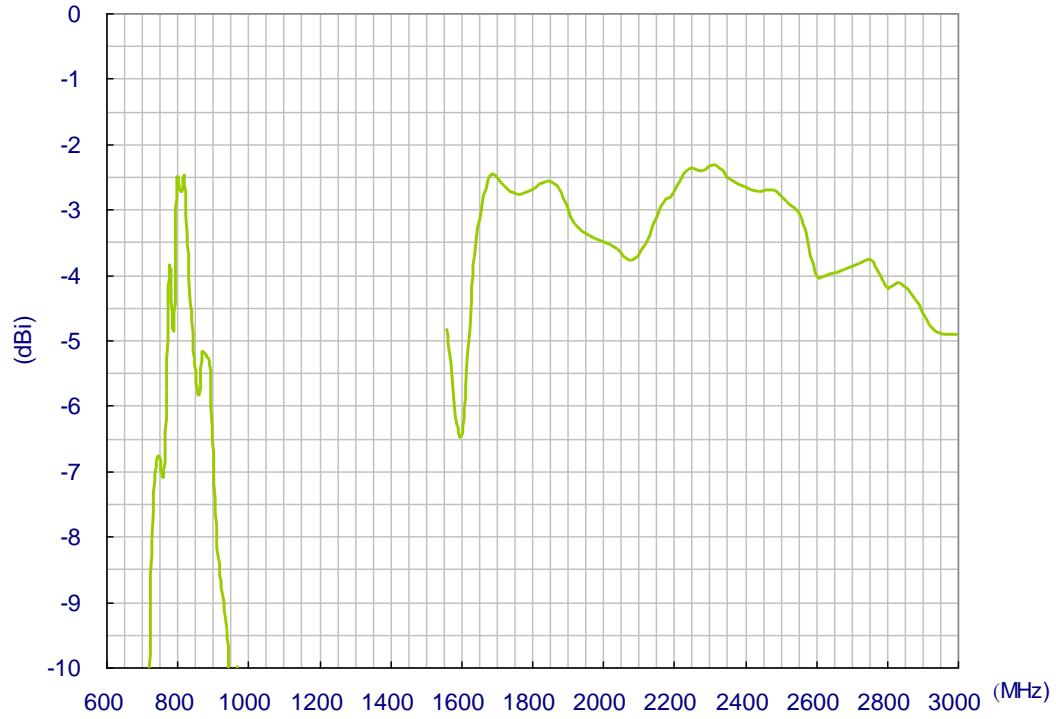

© All Rights Reserved

Taoglas Limited, Unit 7 Peare Campus, Moyne Business Park, Old Dublin Road,
Enniscorthy, Co. Wexford, Ireland www.taoglas.com



Specification

IV.6. Cellular Antenna Radiation Pattern

XY-plane

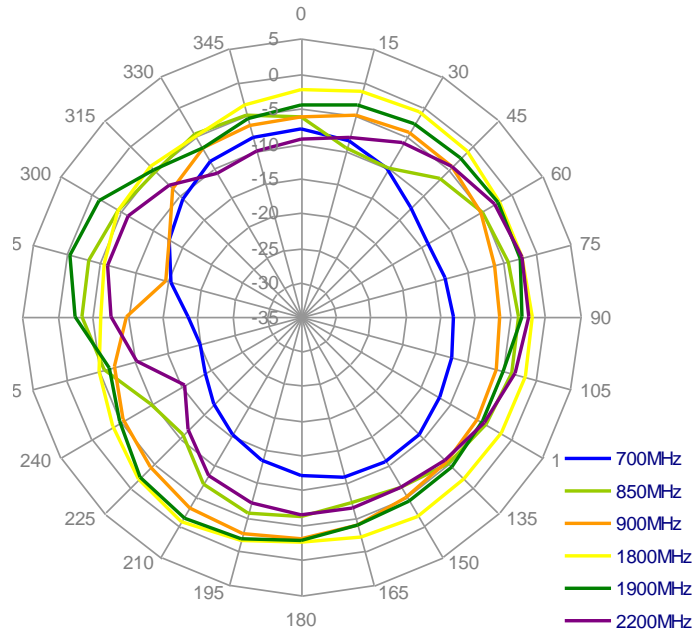

XZ-plane

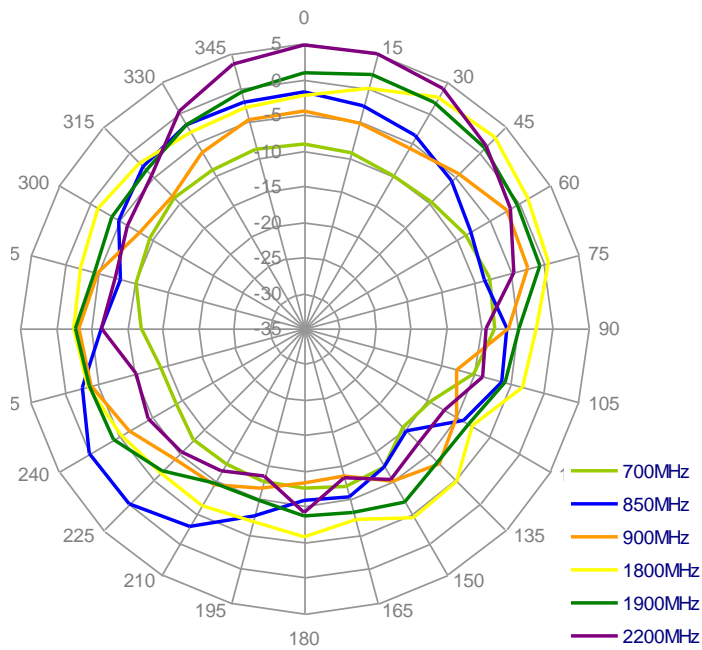



V. 2.4/5GHz Antenna Characteristics

V.1. S11 Retune Loss

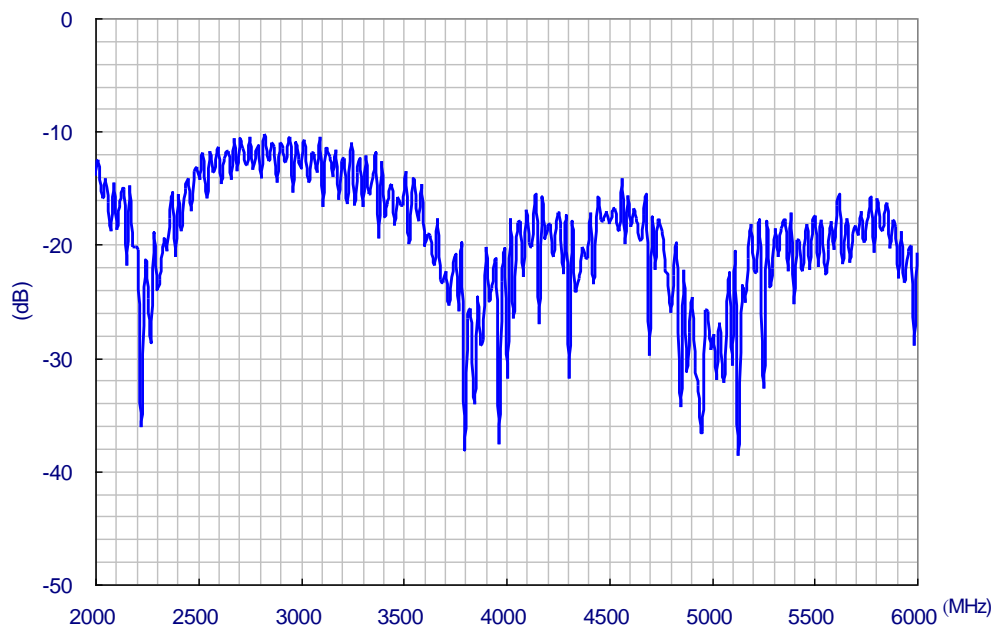

V.2. VSWR

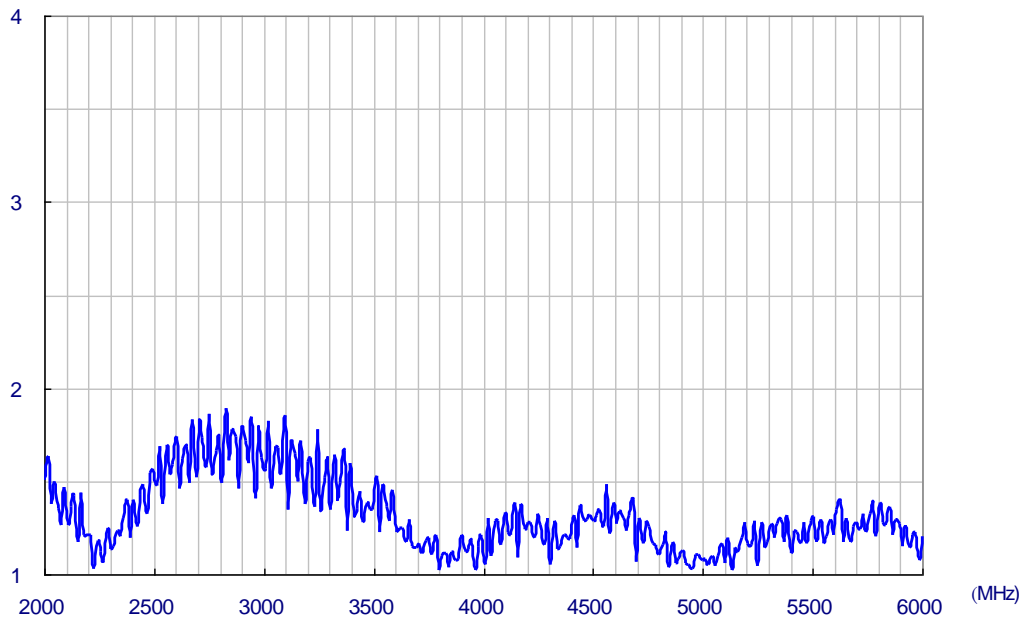

© All Rights Reserved

Taoglas Limited, Unit 7 Peare Campus, Moyne Business Park, Old Dublin Road,
Enniscorthy, Co. Wexford, Ireland www.taoglas.com



Specification

V.3. 2.4/5GHz Antenna Efficiency

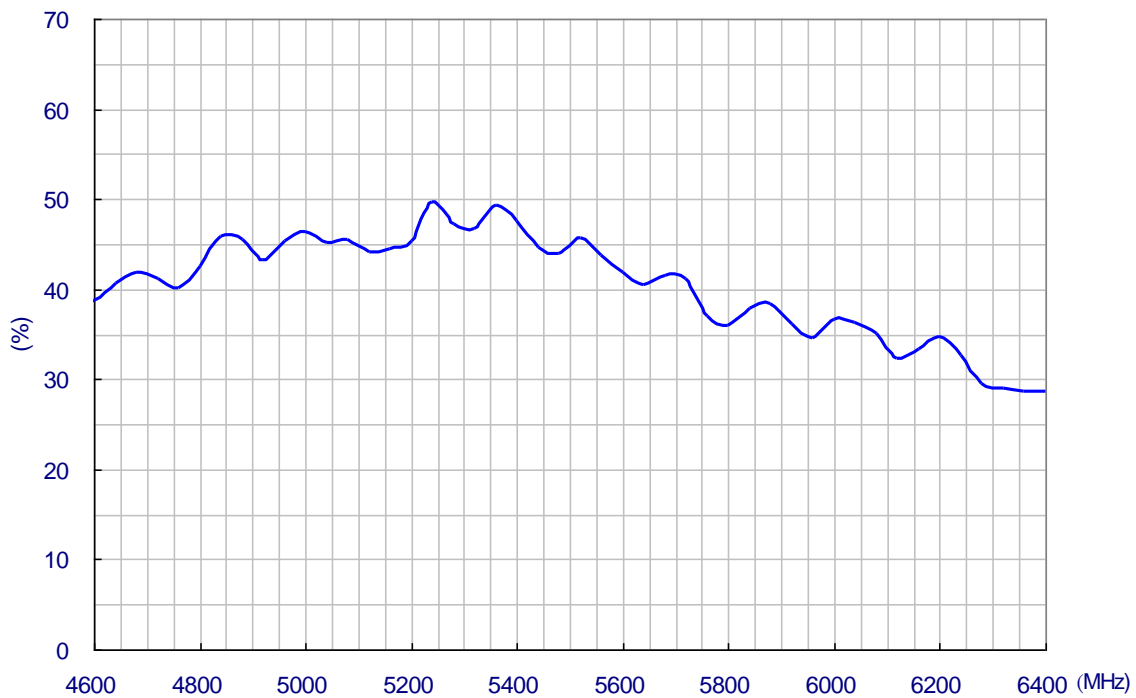
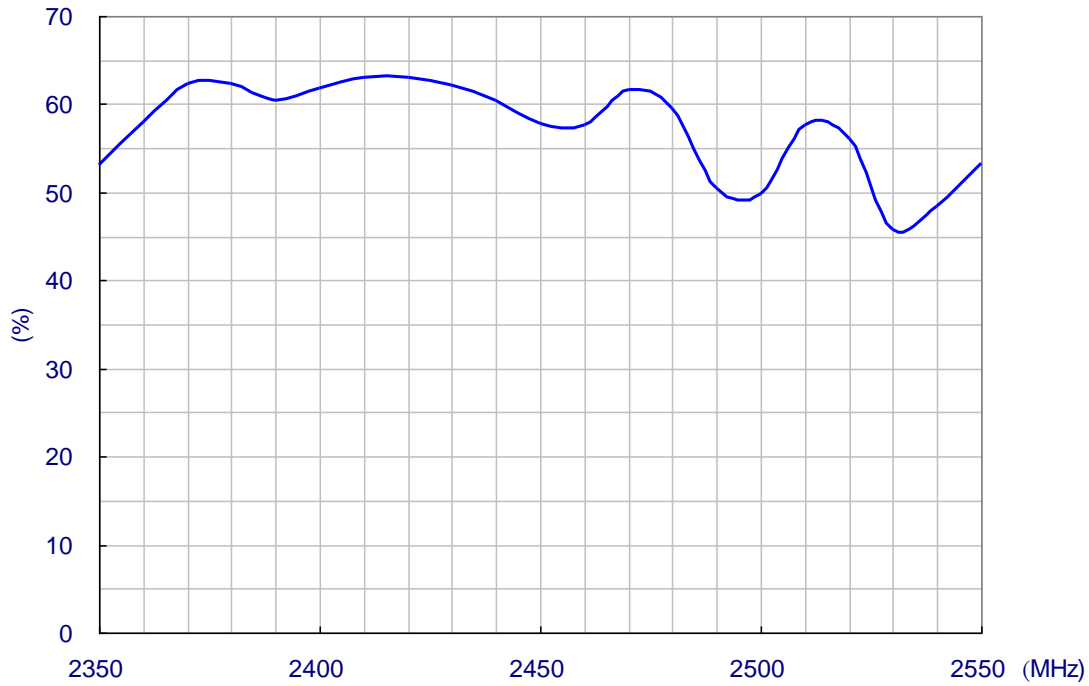



Specification

V.4. 2.4/5GHz Antenna Peak Gain

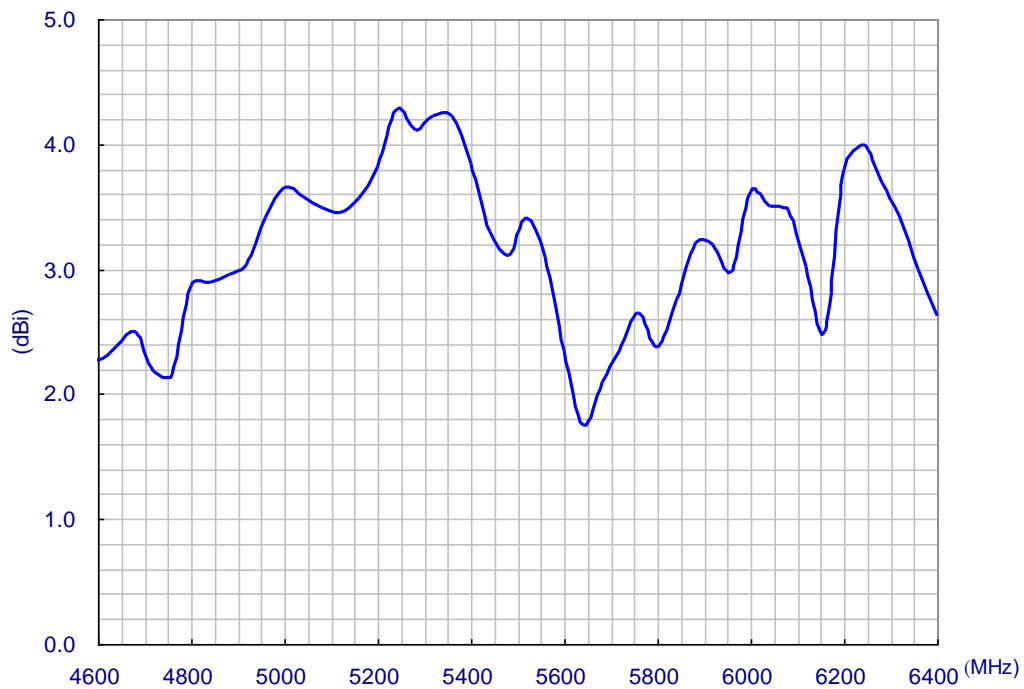
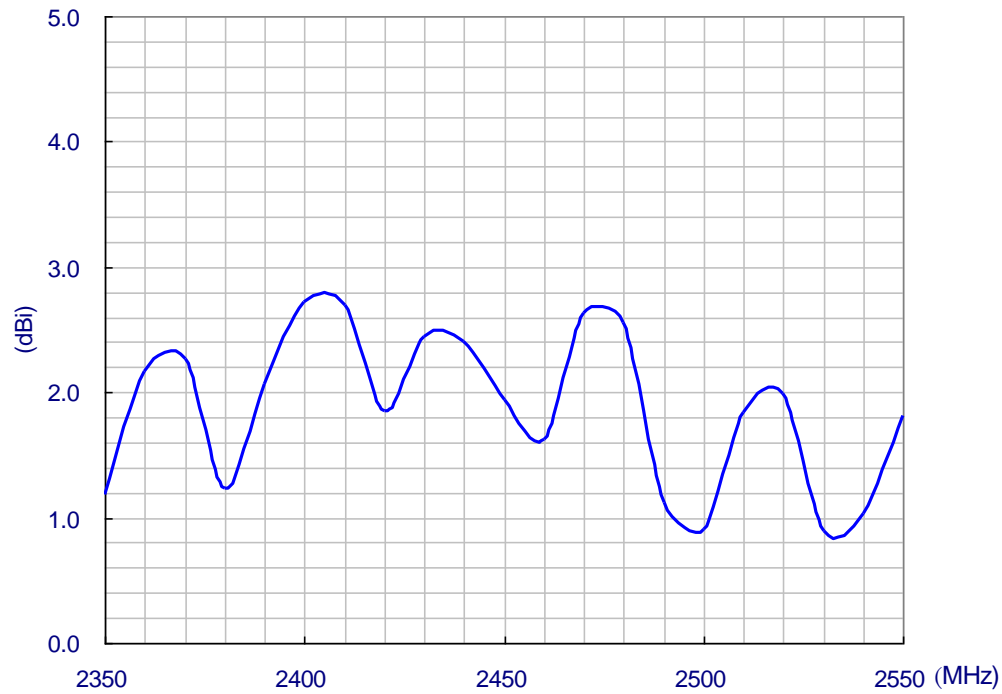

© All Rights Reserved
Taoglas Limited, Unit 7 Peare Campus, Moyne Business Park, Old Dublin Road,
Enniscorthy, Co. Wexford, Ireland www.taoglas.com



Specification

V.5. 2.4/5GHz Antenna Peak Gain

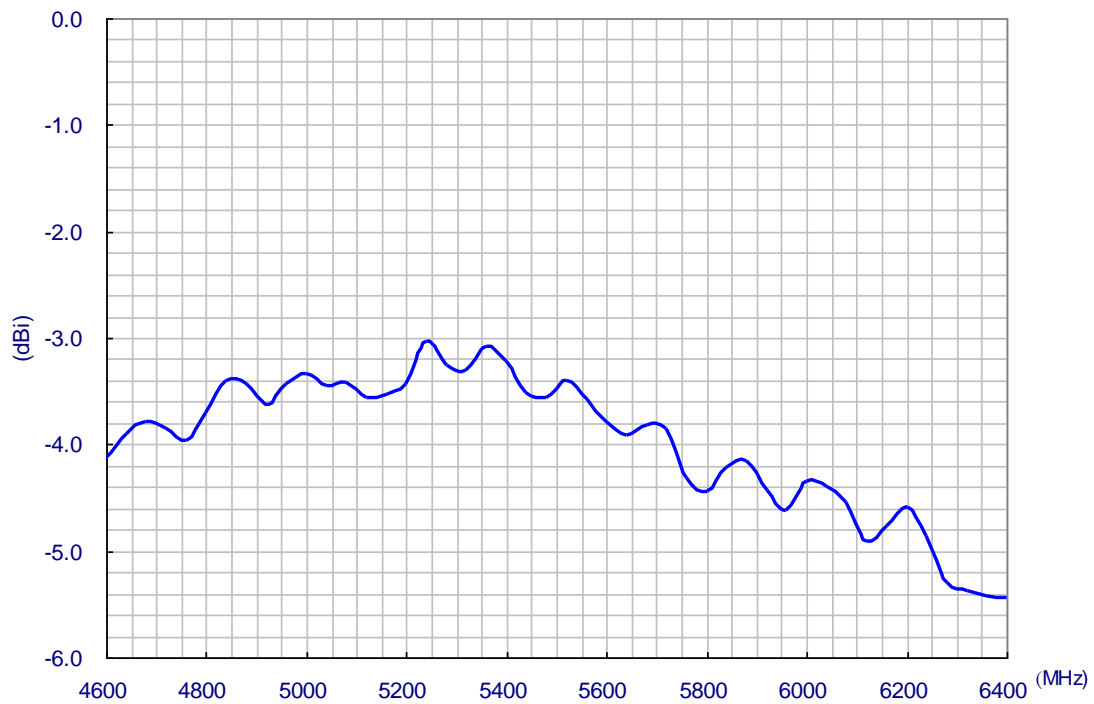
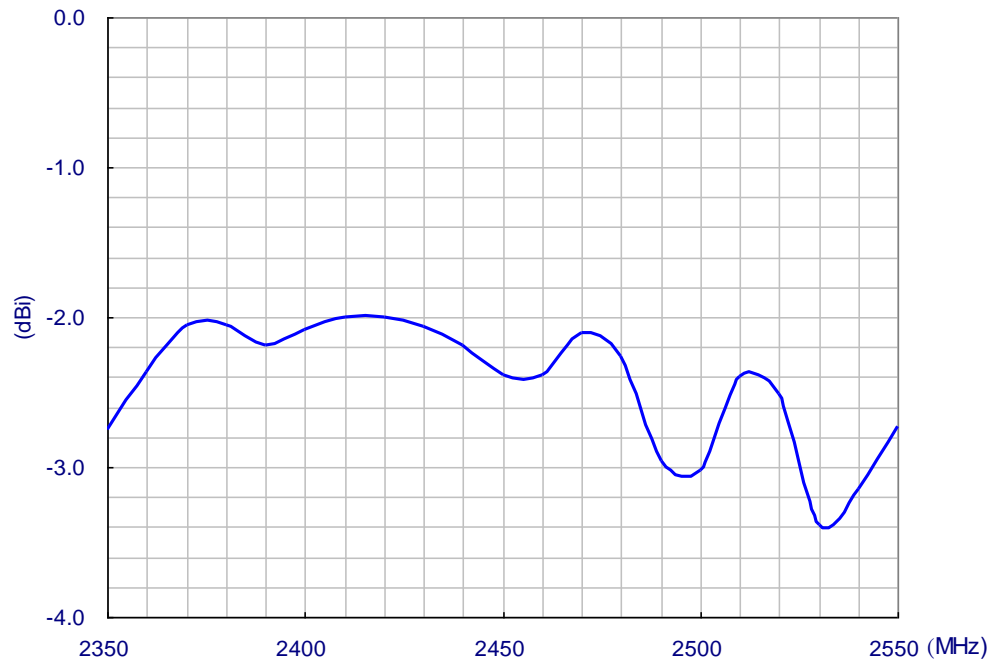

© All Rights Reserved
Taoglas Limited, Unit 7 Peare Campus, Moyne Business Park, Old Dublin Road,
Enniscorthy, Co. Wexford, Ireland www.taoglas.com



Specification

V.6. 2.4/5GHz Antenna Radiation Pattern

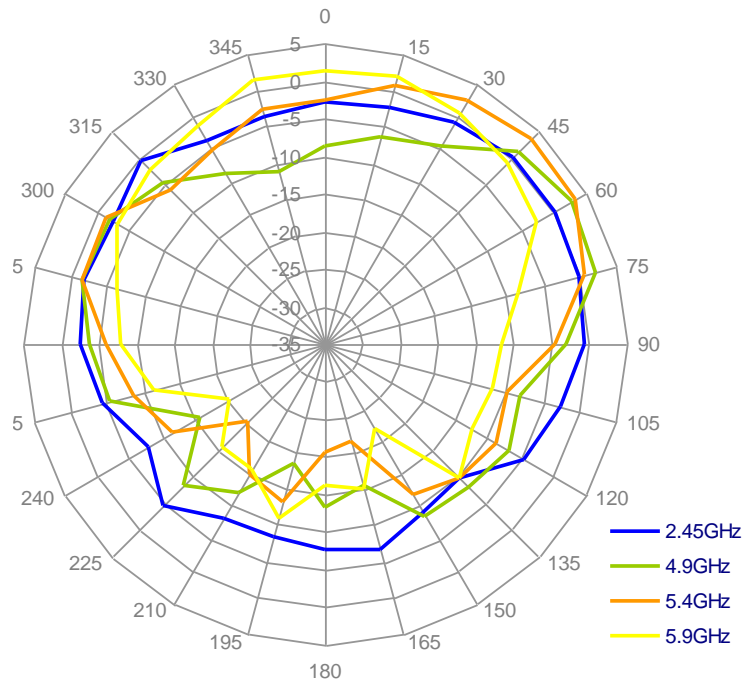
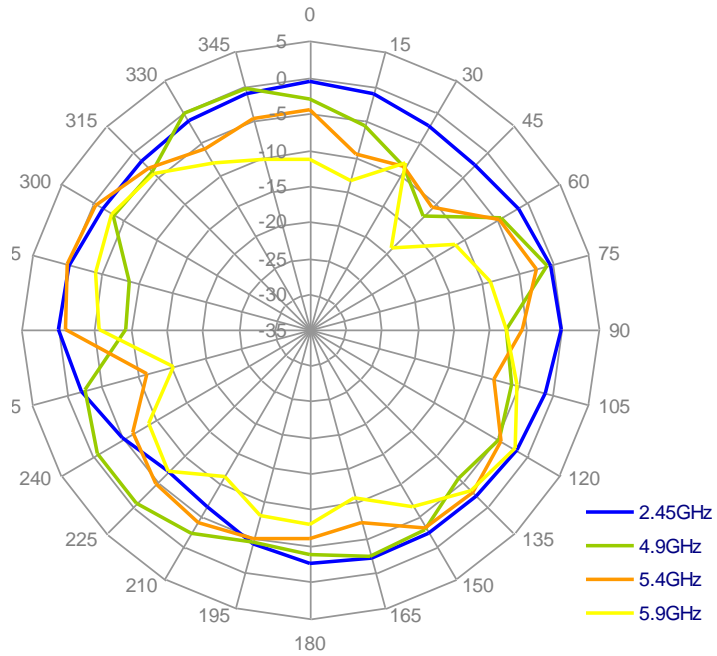

© All Rights Reserved
Taoglas Limited, Unit 7 Peare Campus, Moyne Business Park, Old Dublin Road,
Enniscorthy, Co. Wexford, Ireland www.taoglas.com



Specification

VI. Mechanical Drawing

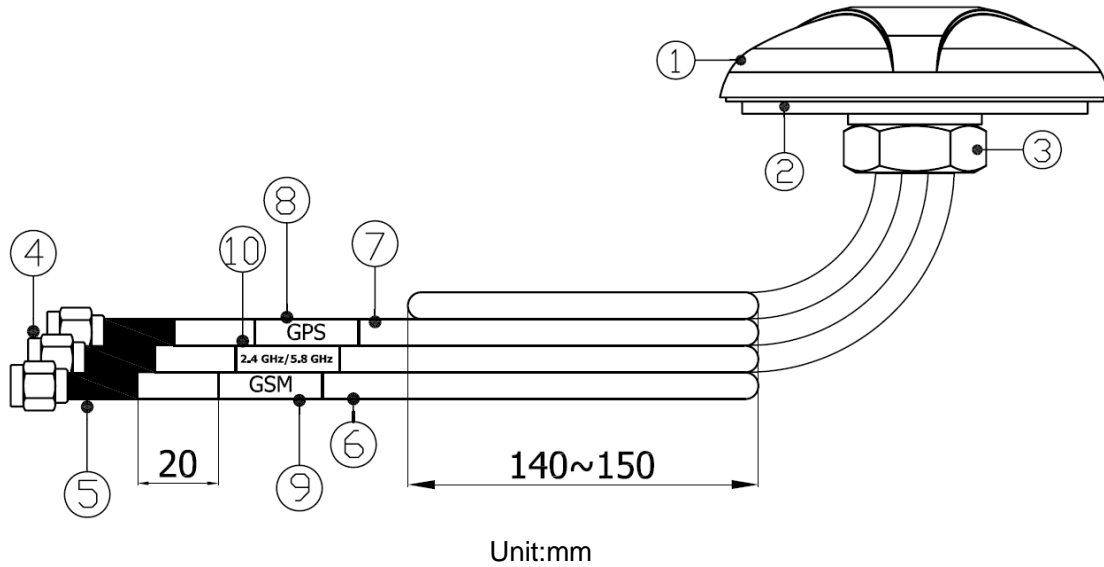

No.	Item	Description
1	Antenna Cover	Black ABS
2	Bottom Cover	Zinc Alloy
3	Hexagon Nut	Ø30mm, H18mm
4	Connector	SMA
5	Heat Shrink Tube	Black H.S tube
6	CFD 200 Cable	3m standard
7	RG.174 cable	3m standard
8	Label	GPS label, orange
9	Label	GSM label, blue
10	Label	WiFi label, green

© All Rights Reserved

Taoglas Limited, Unit 7 Peare Campus, Moyne Business Park, Old Dublin Road,
Enniscorthy, Co. Wexford, Ireland www.taoglas.com



Specification

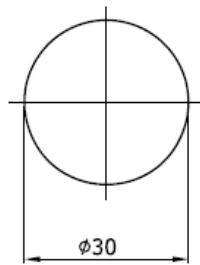
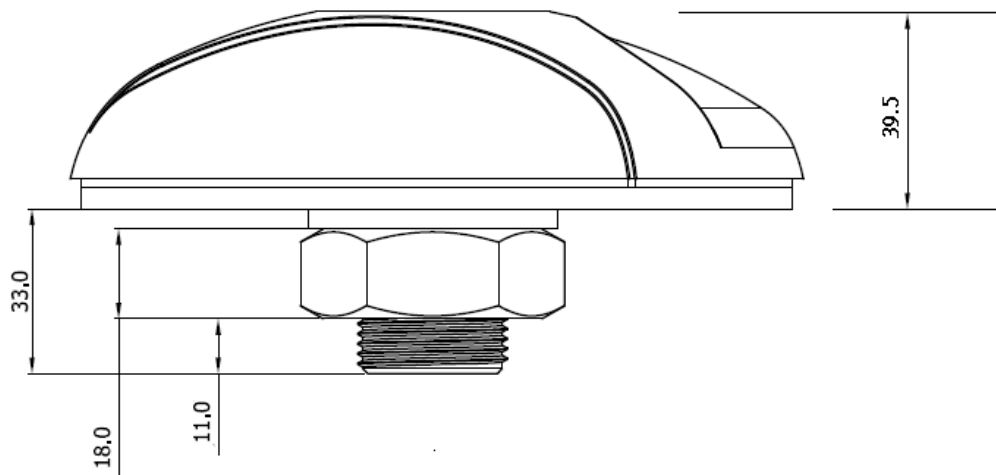
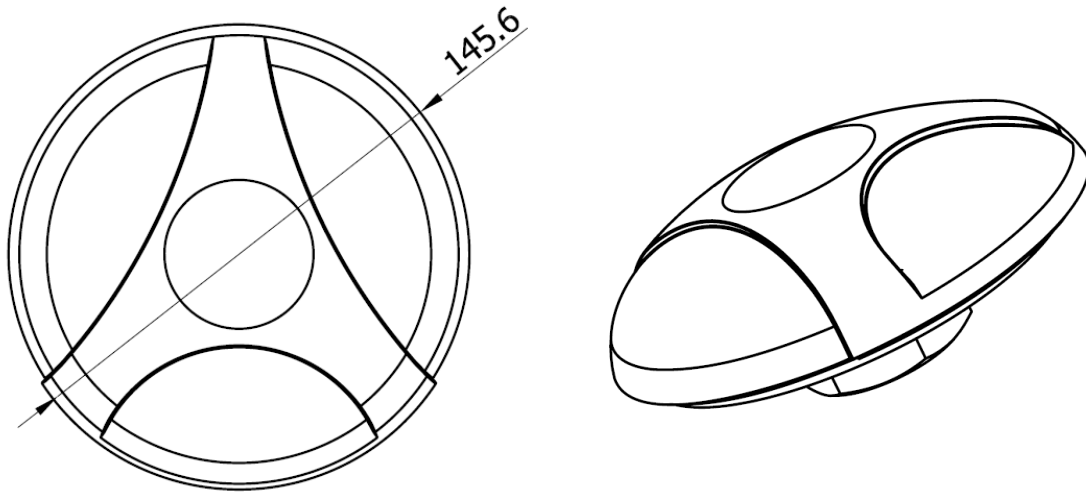

Thread Diameter

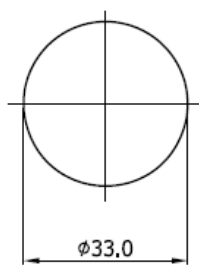

Recommended
Mounting Hole

Unit: mm



VII. Packing

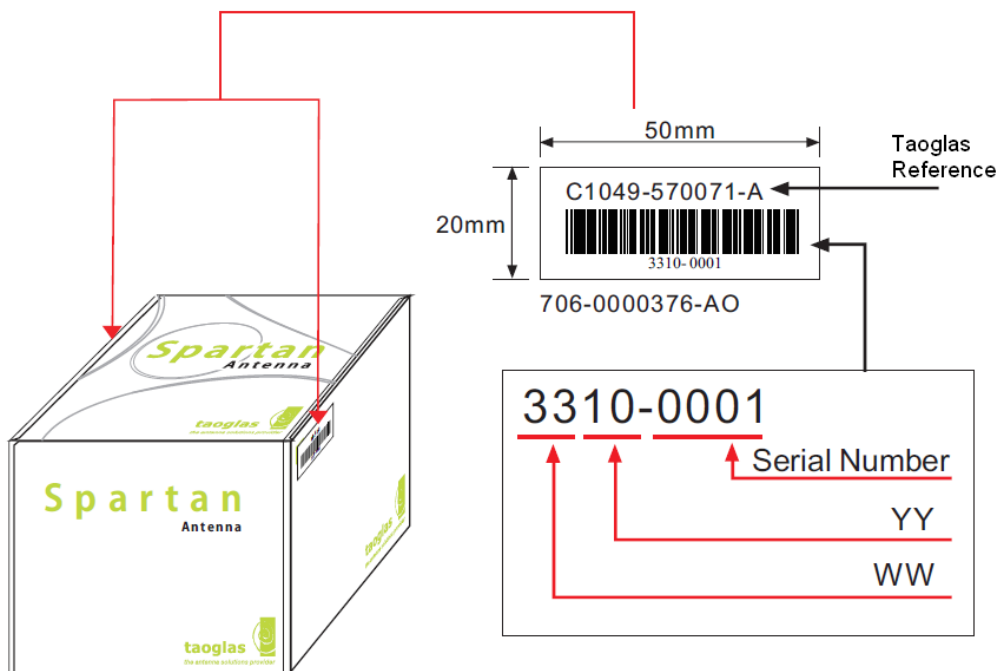
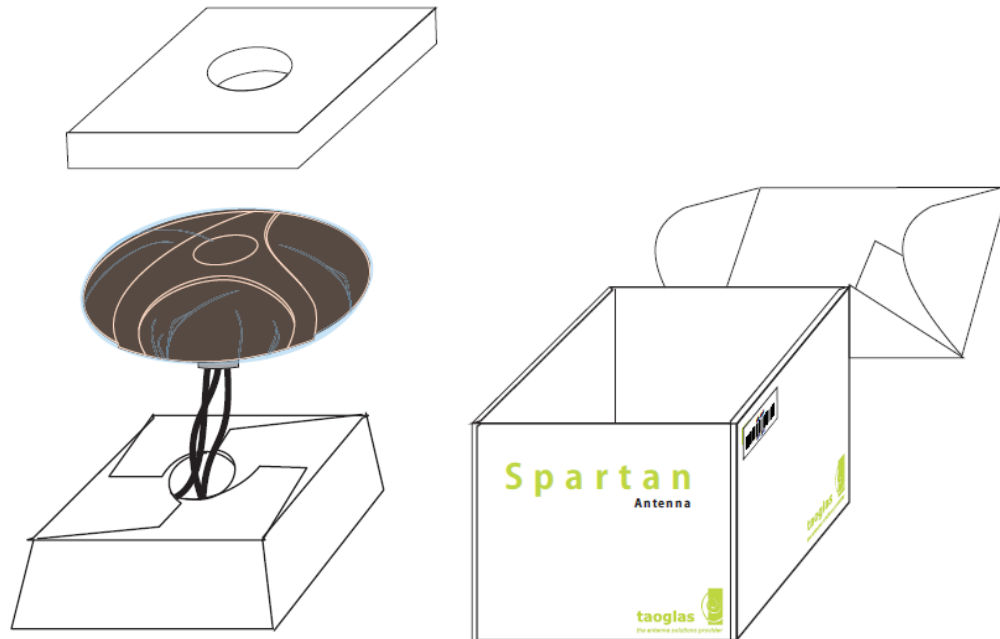

© All Rights Reserved

Taoglas Limited, Unit 7 Peare Campus, Moyne Business Park, Old Dublin Road,
Enniscorthy, Co. Wexford, Ireland www.taoglas.com



Specification

8 boxes per carton

