

SPECIFICATION

Part No. : **IP.1621.25.4.A.02**

Specification No : **IP.25A**

Product Name : **4mm thick Iridium Patch Antenna, 1621MHz
(PA025AO0000)**

Features : 25mm*25mm*4mm
ROHS Compliant

:



1.0 Introduction

This miniaturized ceramic Iridium patch antenna is based on smart **XtremeGain™** technology. It is mounted via pin and double-sided adhesive and has been selected as optimal solution for the customer device environment.

2.0 Key Antenna Performance Indicators

Original Patch Specification tested on 50*50mm ground plane

No	Parameter	Specification	Notes
1	Range of Receiving Frequency	1616~1626.5Mhz	
2	Center Frequency	1621MHz ±3MHz	with 50*50mm GND Plane
3	Bandwidth	16MHz	Return Loss ≤-10dB
4	VSWR	1.5 max	Center Frequency
5	Gain at Zenith	+2.0dBi typ.	Center Frequency
6	Gain at 10° Elevation	--	Center Frequency
7	Axial Ratio	3 dB Max	Center Frequency
8	Polarization	RHCP	
9	Impedance	50Ω	
10	Frequency Temp Coefficient (Tf)	0±20ppm/°C	-40°C to +85°C
11	Operating Temperature	-40°C to +85°C	
12	Antenna Weight	10g	

3.0 Mechanical Specifications

3.1 Shape and Dimension

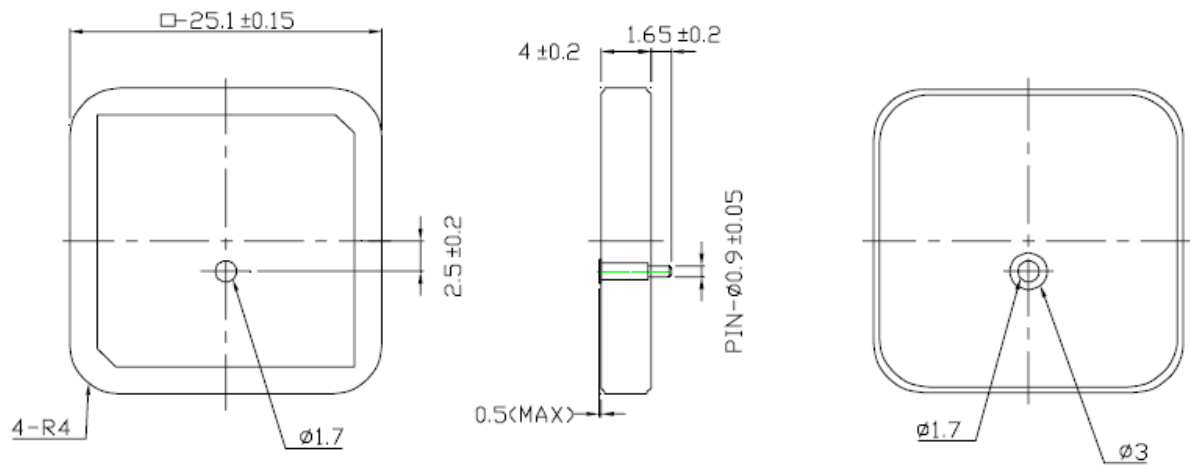

3.2 Layout

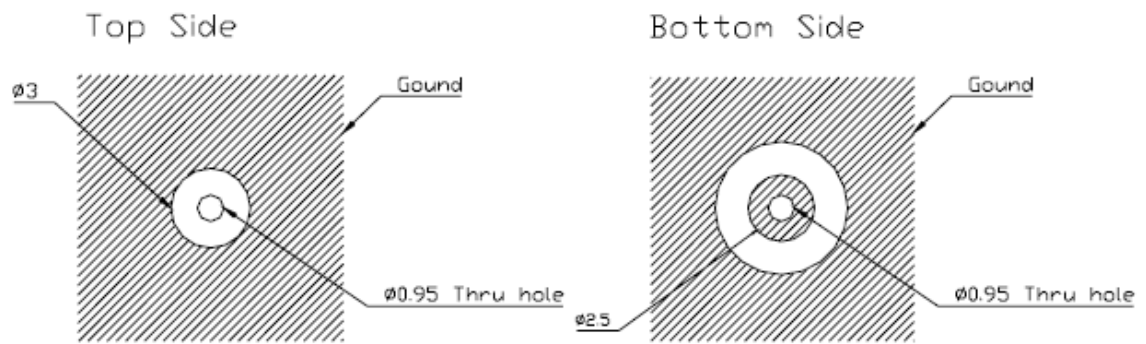

TOL: ± 0.20
UNIT: mm

Tape Dimension

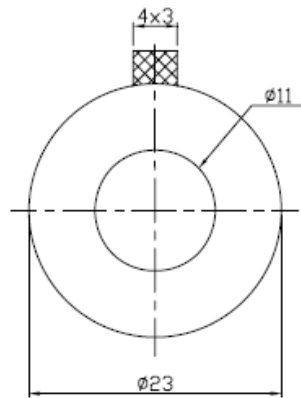

1. NITTO : NO.5015
2. Double-coated adhesive tape for industrial use
3. Thickness : 0.12mm

Mark

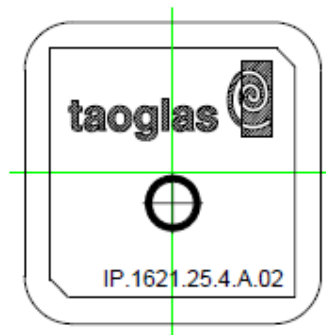

3.3 Test Jig and Dimensions

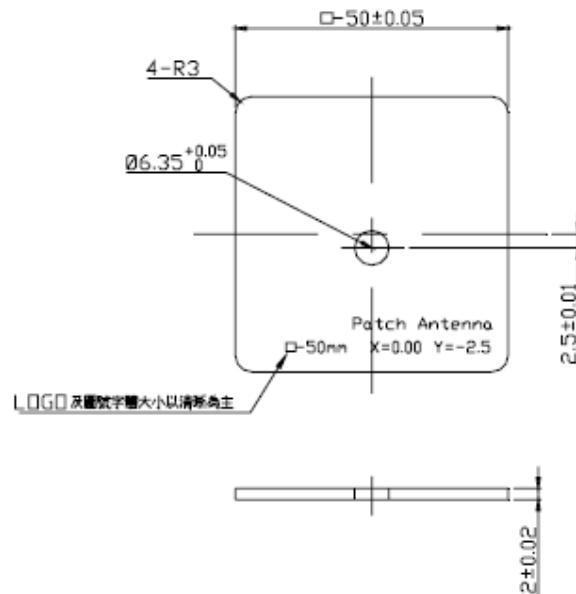

3.4 Test Fixture Antenna Setup and Measurements

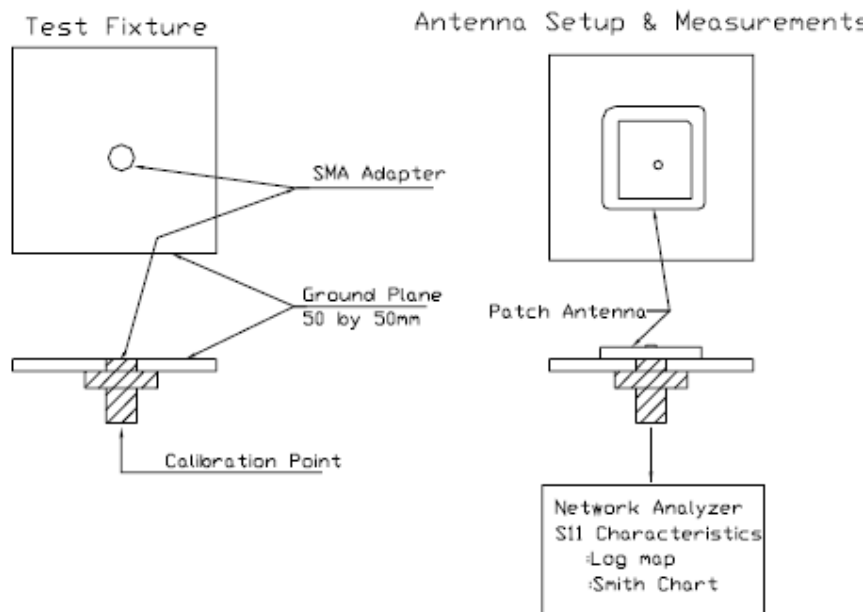

4.0 Performance testing and results

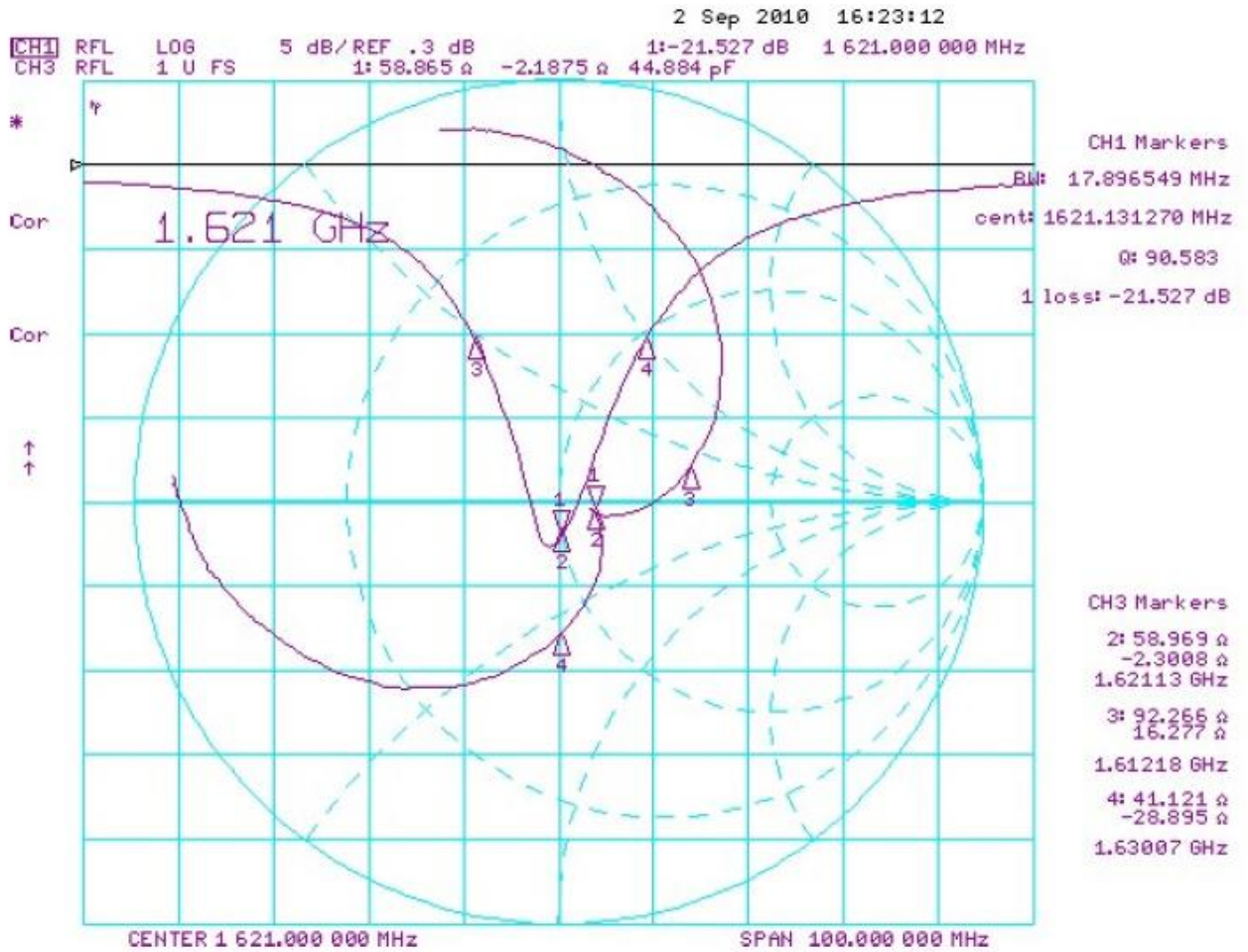

Antenna Gain Chart

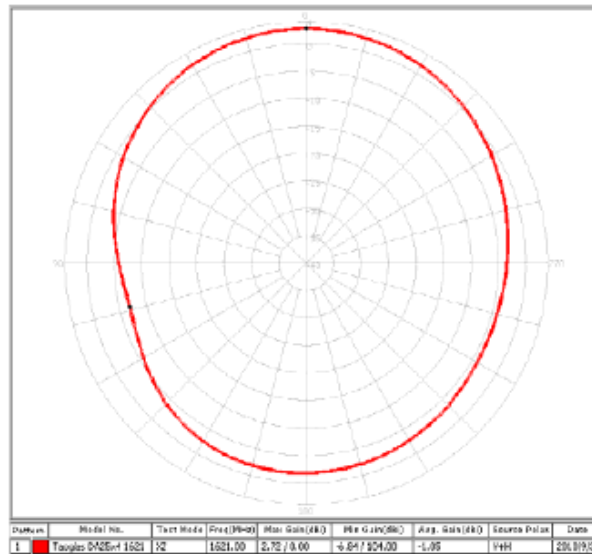

XZ-Plane

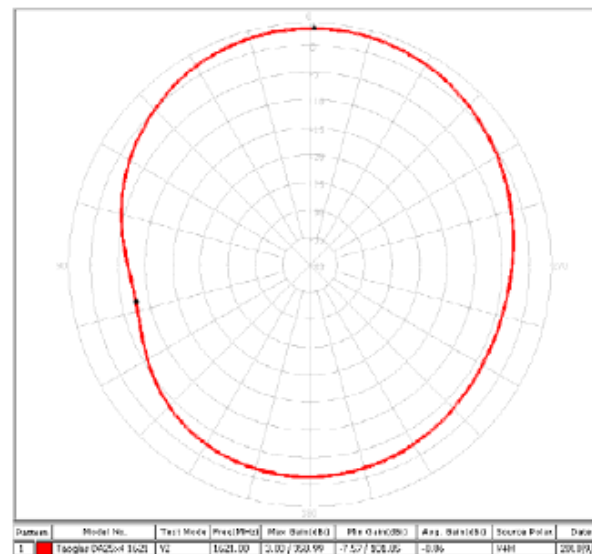

YZ-Plane

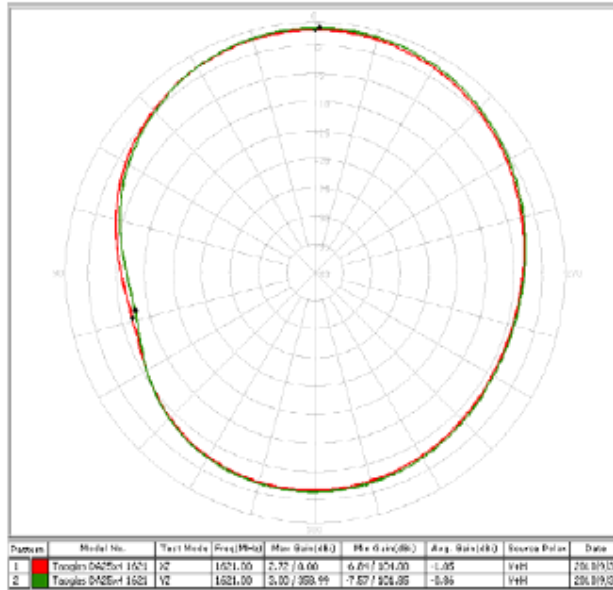

XZ+YZ-Plane

Plane	Max Gain(dBi)	Min Gain(dBi)	Avg. Gain(dBi)
XZ	2.72/1.00	-6.84/104	-1.05
YZ	3.00/358.99	-7.57/101.85	-0.86

Axial Ratio

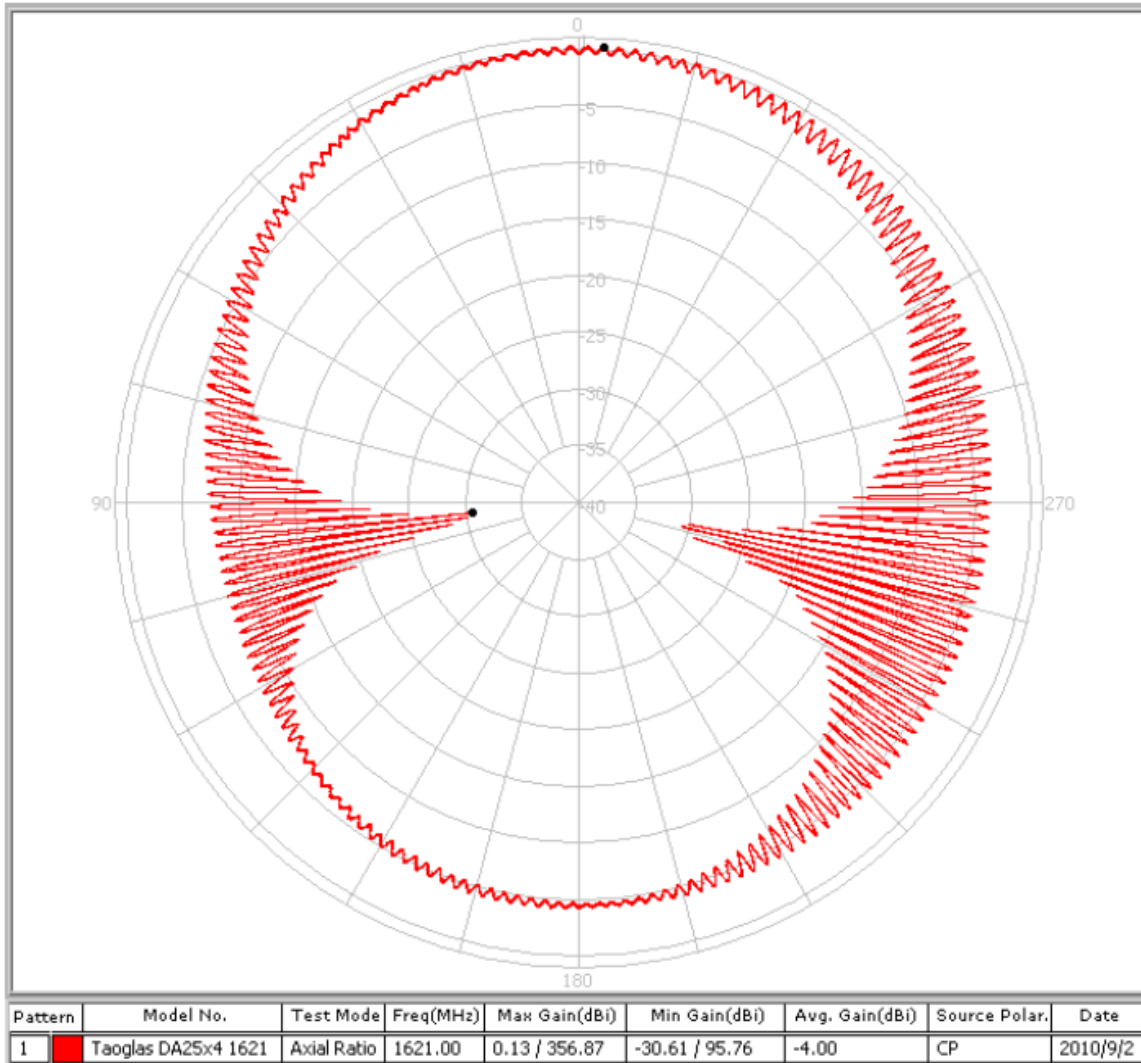

5.0 Packaging

- Per Tray: 50 pieces
- Per Carton(Inside Box) – 4 Trays = 200 pieces
- Outer Carton (Outside Box)– 4 Cartons = 800 pieces

