

XBee 5V/3.3V Adapter (#32401)

This low cost XBee 5V/3.3V Adapter comes in partially assembled kit form and provides a cost-effective solution for interfacing your microcontroller to any XBee or XBee Pro module. A voltage regulator and 74LVC244A buffer is included onboard for safe interfacing to a 5 V supply, allowing for easy compatibility with any Parallax microcontroller.

Features

- Onboard 3.3 V regulator and 5 V to 3.3 V logic converters
- Four status indicator LEDs for Power, RSSI, Associate and mode (sleep/ON)
- Converts XBee 2 mm pin spacing to 0.100" pin spacing
- Provides easy pluggable wire or solder connections
- Pin-out compatible with other Parallax XBee Adapter Boards
- Partially assembled kit form for flexible configuration
- Compatible with all Parallax microcontrollers

Key Specifications

- Power requirements: 3.3–5 VDC
- Communication: Serial pass-through to XBee module
- Operating temperature: -40 to 158 °F (-40 to 70 °C)
- Dimensions (with headers attached): 1.51 x 1.00 x 0.58 in (38.3 x 25.6 x 14.8 mm*)

Kit Contents

- (1) XBee 5V/3.3V PCB (SMD components pre-soldered)
- (2) 10-pin 2mm sockets
- (1) 40-pin SIP header

Tools Required

- Soldering iron (always wear safety glasses when soldering)
- Solder (some soldering experience required)
- Flux
- Diagonal cutters or hobby knife

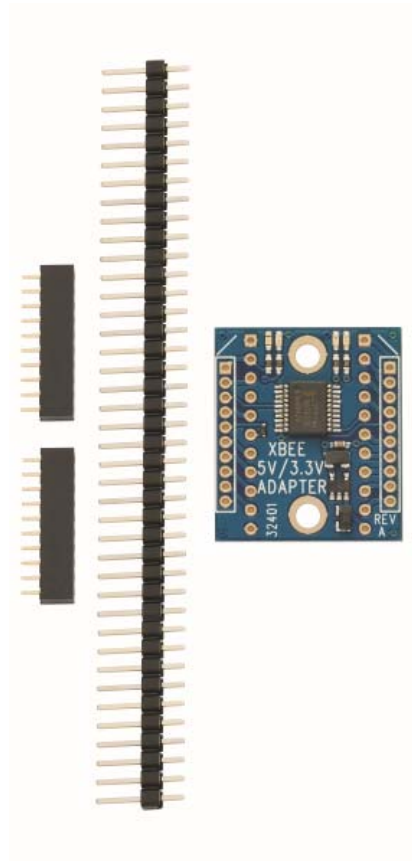

Assembly Instructions

Step 1:

Check to ensure your kit contains the following parts as shown in the photo.

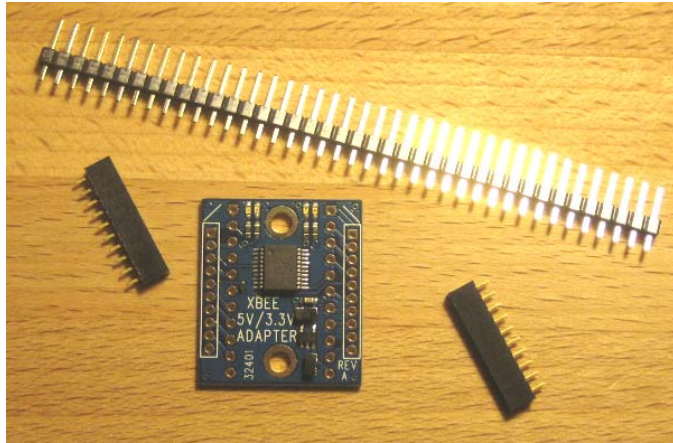

Step 2:

Install the 2mm sockets on top of the PCB as shown, and then solder them in place from the bottom side of the board.

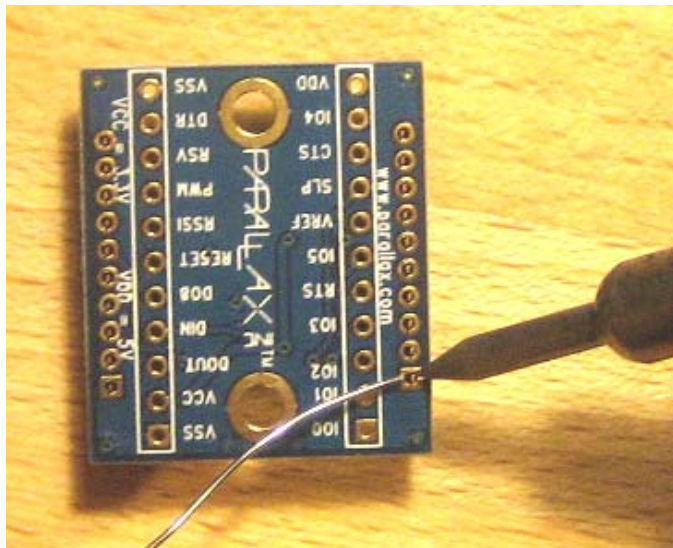
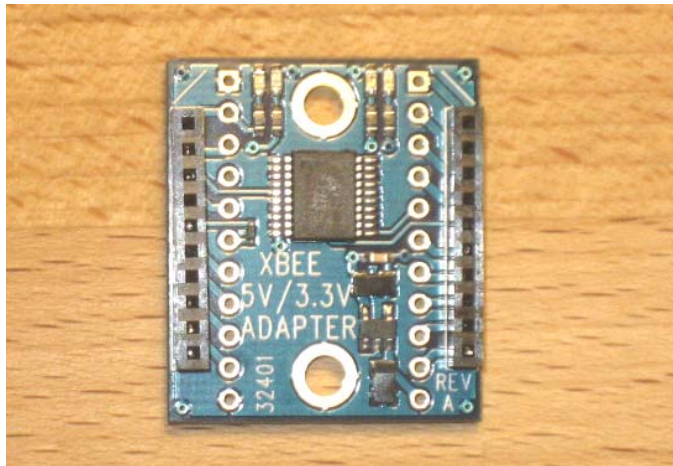

Step 3:

Using a hobby knife or a pair of diagonal cutters, cut two 11-pin headers from the 40-pin header. Extra header material is included in case of mistake or damage.

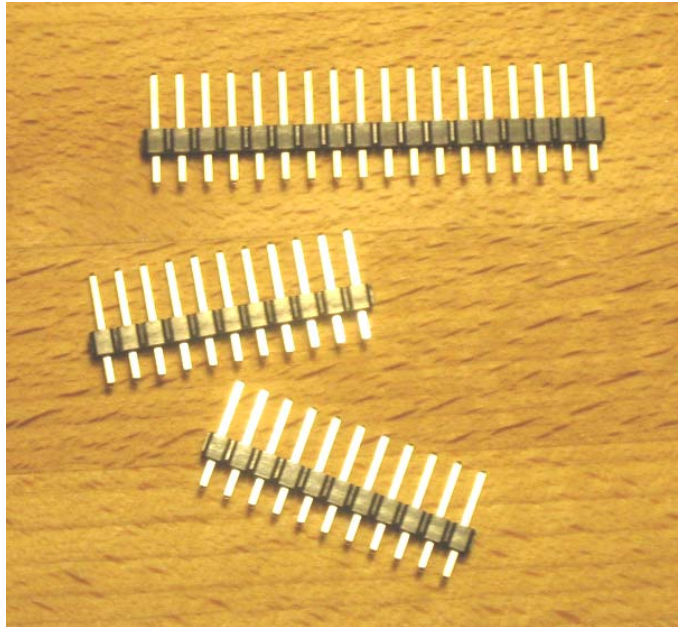

Step 4 (optional):

Insert the two 11-pin SIP headers into the bottom of the adapter board as shown and solder them in place from the top.

This step is optional in that you can solder wires directly to the pads if desired.

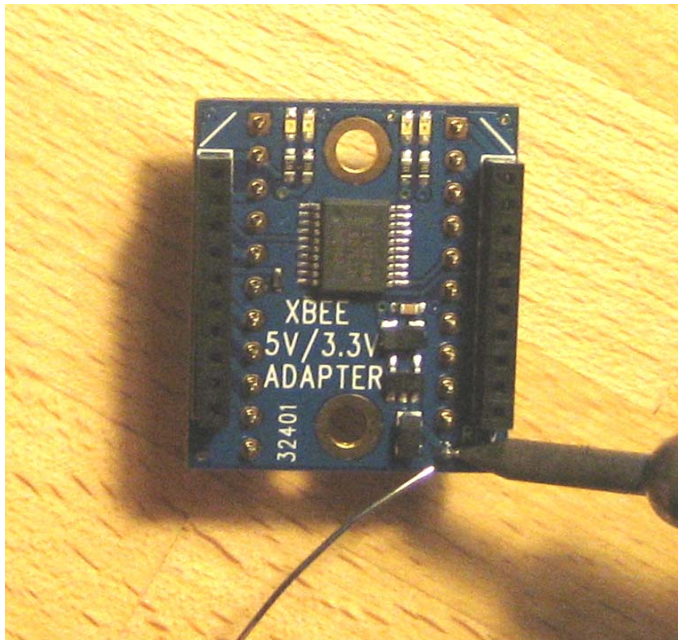

LED Status Indicators

The XBee 5V/3.3V Adapter has four LEDs onboard for easy feedback of module status. These four LED colors and functions are listed in the table below:

LED Color	Function
Blue	Power`
Yellow	Module ON (not in standby)
Red	RSSI
Green	Associate

Connecting and Testing

While the XBee RF Modules are 3.3V devices, the XBee 5V/3.3V Adapter provides a means to interface your XBee with a BASIC Stamp or other 5 V microcontroller. The DIN, DOUT and /RTS pins interface to the XBee through a 74LVC244A buffer, safely regulating 5 V signals to 3.3 V.

The supply voltage (whether 3.3 V or 5 V) should be connected to the VDD pin on the adapter board, which is run through a 3.3V regulator and supplied to the XBee through the VCC pin. **Do not connect an additional external voltage supply to the VCC pin if power is already applied through VDD. This could damage to your XBee module.**

Caution: Voltage regulator supply current limitation.

The FAN2500S33X regulator used on Rev A of this adapter is rated at 100 mA continuous, 300 mA peak current. VCC may be used as a 3.3 V supply output, but be sure that you budget enough current for your XBee module as well as any other device you might supply through this regulator. The regular XBee modules (Series 1 and Series 2) draw less than 55 mA, but XBee Pro modules can draw over 200 mA when in a continuous-transmit state. While this adapter board can supply enough current for the intermittent transmissions of XBee Pro modules typical to many common uses, applications requiring continuous, sustained transmissions from XBee Pro modules would be better suited to the XBee SIP Adapter (#32402), or the XBee Adapter Board (#32403) with an external regulator (not included).

Module Dimensions

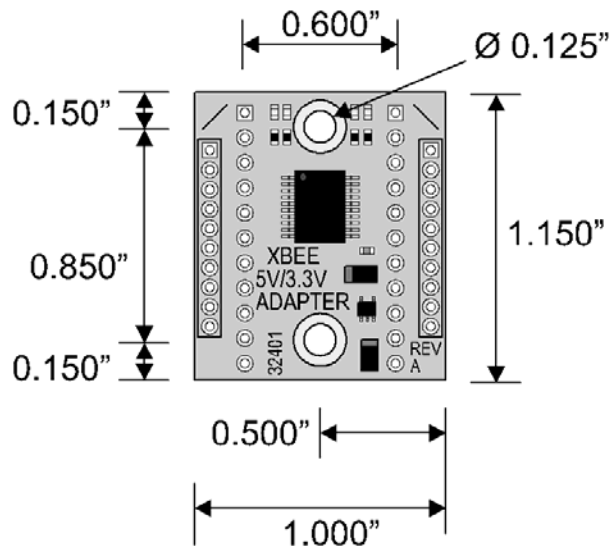

Connection Diagrams

The example code below utilizes a pushbutton connected to Pin 13 on the transmitter board, and an LED connected to Pin 13 the receiver board, while the connection for the XBee 5V/3.3V Adapter remains the same for both boards.

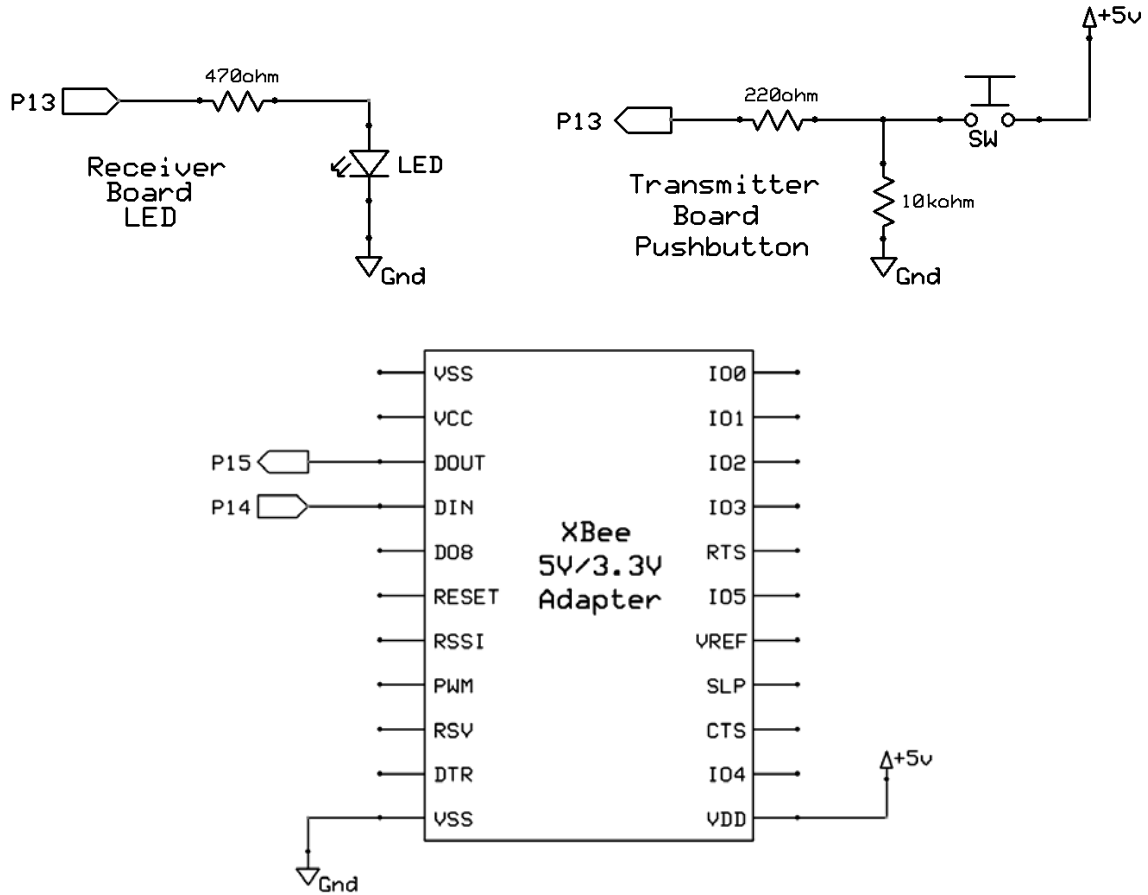

BASIC Stamp[®] 2 Program Examples

The sample code below demonstrates simple communication using two XBee modules interfacing with two BASIC Stamp 2 microcontrollers. The first program, XBeeTX_PbLed.bs2 sends the state of a pushbutton connected to P13 while the second program, XBeeRX_PbLed.bs2 receives the state of the pushbutton, displays it on the Debug Terminal, and turns on an LED if the button is pressed. Both programs can be downloaded from the 32401 product page at www.parallax.com.

```
' {$STAMP BS2}
' {$PBASIC 2.5}

' XBeeTX_PbLed.bs2
' Sends state of an active-high pushbutton connected to P13

TX      PIN    14                      ' XBee DIN pin

DO
  SEROUT TX, 84, [BIN IN13, CR]      ' Sends state of pushbutton
  PAUSE 250                          ' Short pause
LOOP                                     ' Loop forever
```

```
' {$STAMP BS2}
' {$PBASIC 2.5}

' XBeeRX_Simple.bs2
' Received state of pushbutton, displays state in Debug Terminal
' and turns on an LED if the button is pressed.

RX      PIN    15                      ' XBee DOUT pin
PbState VAR    Bit                    ' Variable space for pushbutton state

DO
  SERIN RX, 84, [BIN PbState]        ' Receives pushbutton state

  DEBUG HOME, ? PbState              ' Displays state in Debug Terminal
  IF PbState = 1 THEN HIGH 13 ELSE LOW 13 ' LED on if pressed/off if not pressed
LOOP                                  ' Loop forever
```