

TruStability™ Silicon Pressure Sensors: HSC Series—High Accuracy

±1% Total Error Band,
Amplified Compensated Digital Output,
1 psi to 150 psi (60 mbar to 10 bar)

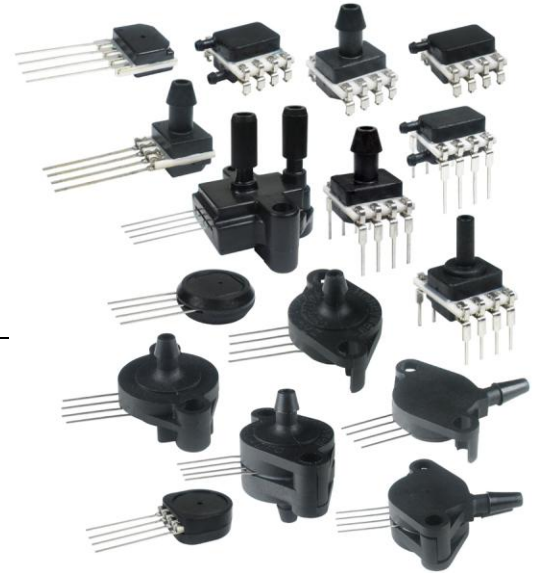

DESCRIPTION

The TruStability™ High Accuracy Silicon Ceramic (HSC) Series is a piezoresistive silicon pressure sensor offering a digital output for reading pressure over the specified full scale pressure span and temperature range.

The HSC Series is fully calibrated and temperature compensated for sensor offset, sensitivity, temperature effects, and non-linearity using an on-board Application Specific Integrated Circuit (ASIC). Calibrated output values for pressure are updated at approximately 2 kHz.

The HSC Series is calibrated over the temperature range of 0 °C to 50 °C [32 °F to 122 °F]. The sensor is characterized for operation from a single power supply of either 3.3 Vdc or 5.0 Vdc.

These sensors measure absolute, differential, and gage pressures. The absolute versions have an internal vacuum reference and an output value proportional to absolute pressure. Differential versions allow application of pressure to either side of the sensing diaphragm. Gage versions are referenced to atmospheric pressure and provide an output proportional to pressure variations from atmosphere.

The HSC Series sensors are intended for use with non-corrosive, non-ionic working fluids such as air and dry gases. They are designed and manufactured according to standards in ISO 9001.

FEATURES

- Industry-leading long-term stability
- Extremely tight accuracy of ±0.25% FSS BFSL (Full Scale Span Best Fit Straight Line)
- Total error band of ±1% full scale span maximum
- Modular and flexible design offers customers a variety of package styles and options, all with the same industry-leading performance specifications
- Miniature 10 mm x 10 mm [0.39 in x 0.39 in] package
- Low operating voltage
- Extremely low power consumption
- I²C- or SPI- compatible 14-bit digital output (min. 12-bit sensor resolution)
- Precision ASIC conditioning and temperature compensated over 0 °C to 50 °C [32 °F to 122 °F] temperature range
- RoHS compliant
- Virtually insensitive to mounting orientation
- Internal diagnostic functions increase system reliability
- Also available with analog output
- Absolute, differential and gage types
- Pressure ranges from 1 psi to 150 psi (60 mbar to 10 bar)
- Custom calibration available
- Various pressure port options

TruStability™ Silicon Pressure Sensors: HSC Series—High Accuracy

POTENTIAL APPLICATIONS

- | | |
|---|--|
| <ul style="list-style-type: none"> • Medical: <ul style="list-style-type: none"> - Airflow monitors - Anesthesia machines - Blood analysis machines - Gas chromatography - Gas flow instrumentation - Kidney dialysis machines - Oxygen concentrators - Pneumatic controls - Respiratory machines - Sleep apnea equipment - Ventilators | <ul style="list-style-type: none"> • Industrial: <ul style="list-style-type: none"> - Barometry - Flow calibrators - Gas chromatography - Gas flow instrumentation - HVAC - Life sciences - Pneumatic controls |
|---|--|

Table 1. Absolute Maximum Ratings¹

Parameter	Min.	Max.	Unit
Supply voltage (V_{supply})	-0.3	6.0	Vdc
Voltage on any pin	-0.3	$V_{\text{supply}} + 0.3$	V
Digital interface clock frequency:			
I ² C	100	400	kHz
SPI	50	800	
ESD susceptibility (human body model)	3	-	kV
Storage temperature	-40 [-40]	85 [185]	°C [°F]
Soldering time and temperature:			
Lead solder temperature (SIP, DIP)	4 s max. at 250 °C [482 °F]		
Peak reflow temperature (SMT)	15 s max. at 250 °C [482 °F]		

Table 2. Operating Specifications

Parameter	Min.	Typ.	Max.	Unit
Supply voltage (V_{supply}) ² :				Vdc
3.3 Vdc	3.0	3.3 ³	3.6	
5.0 Vdc	4.75	5.0 ³	5.25	
<i>Sensors are either 3.3 Vdc or 5.0 Vdc based on listing selected.</i>				
Supply current:				mA
3.3 Vdc supply	-	1.6	2.1	
5.0 Vdc supply	-	2	3	
Compensated temperature range ⁴	0 [32]	-	50 [122]	°C [°F]
Operating temperature range ⁵	-20 [-4]	-	85 [185]	°C [°F]
Startup time (power up to data ready)	-	2.8	7.3	ms
Response time	-	0.46	-	ms
I ² C voltage level low	-	-	0.2	V_{supply}
I ² C voltage level high	0.8	-	-	V_{supply}
Pull up on SDA and SCL	1	-	-	kOhm
Accuracy ⁶	-	-	±0.25	%FSS BFSL
Total error band ⁷	-	-	±1	%FSS ⁸
Output resolution	12	-	-	bits

±1% Total Error Band, Digital Output, 1 psi to 150 psi (60 mbar to 10 bar)

Table 3. Environmental Specifications

Parameter	Characteristic
Humidity	0 % to 95 % RH, non-condensing
Vibration	MIL-STD-202F, Curve AK (20.7 g random)
Shock	MIL-STD-202F, Method 213B, Condition F
Life ⁹	1 million cycles minimum
Solder reflow	J-STD-020-C

Table 4. Wetted Materials¹⁰

Parameter	Port 1 (Pressure Port)	Port 2 (Reference Port)
Covers	high temperature polyamide	high temperature polyamide
Substrate	alumina ceramic	alumina ceramic
Adhesives	epoxy, RTV	epoxy, RTV
Electronic components	ceramic, glass, solder, silicon	silicon, glass, gold, solder

Notes:

1. Absolute maximum ratings are the extreme limits the device will withstand without damage.
2. Ratiometricity of the sensor (the ability of the digital device to maintain performance parameters independent of supply voltage) is achieved within the specified operating voltage for each option.
3. The sensor is not reverse polarity protected. Incorrect application of supply voltage or ground to the wrong pin may cause electrical failure.
4. The compensated temperature range is the temperature range over which the sensor will produce an output proportional to pressure within the specified performance limits.
5. The operating temperature range is the temperature range over which the sensor will produce an output proportional to pressure but may not remain within the specified performance limits.
6. Accuracy: The maximum deviation in output from a Best Fit Straight Line (BFSL) fitted to the output measured over the pressure range at 25 °C [77 °F]. Includes all errors due to pressure non-linearity, pressure hysteresis, and non-repeatability.
7. Total Error Band: The maximum deviation from the ideal transfer function over the entire compensated temperature and pressure range. Includes all errors due to offset, full scale span, pressure non-linearity, pressure hysteresis, repeatability, thermal effect on offset, thermal effect on span, and thermal hysteresis.
8. Full Scale Span (FSS) is the algebraic difference between the output signal measured at the maximum ($P_{max.}$) and minimum ($P_{min.}$) limits of the pressure range. (See Figure 1 for ranges.)
9. Life may vary depending on specific application in which sensor is utilized.
10. Contact Honeywell Customer Service for detailed material information.

TruStability™ Silicon Pressure Sensors: HSC Series—High Accuracy

Figure 1. Nomenclature and Order Guide

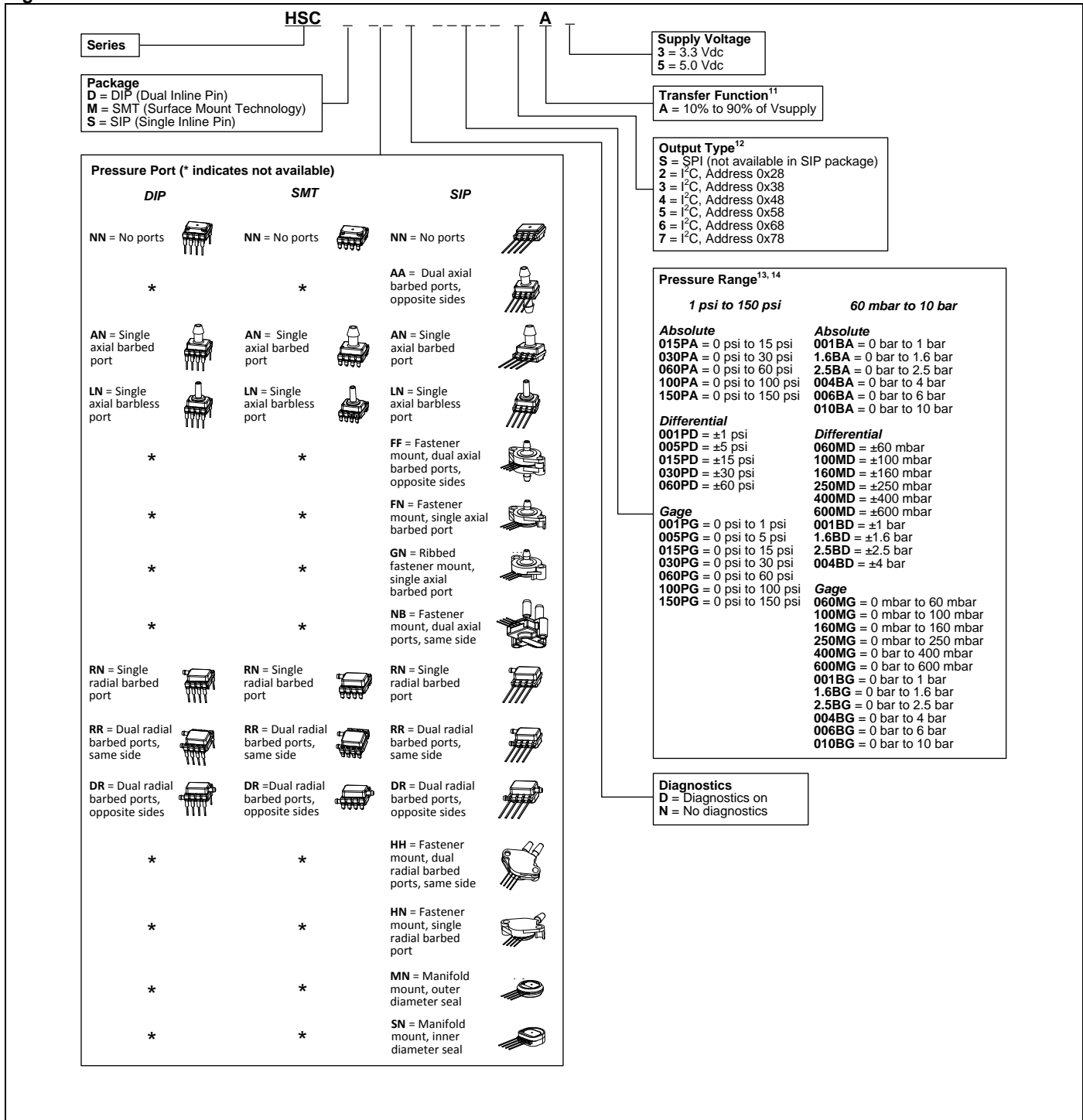

Notes:

- The transfer function limits define the output of the sensor at a given pressure input. By specifying P_{min.} and P_{max.}, the output at P_{min.} and P_{max.}, the complete transfer function of the sensor is defined. See Figure 2 for a graphical representation of the transfer function. Other transfer functions are available. Contact Honeywell Customer Service for more information.
- Analog output is also available. Contact Honeywell Customer Service for more information.
- Custom pressure ranges are available. Contact Honeywell Customer Service for more information.
- See Table 5 for an explanation of sensor pressure types.

±1% Total Error Band, Digital Output, 1 psi to 150 psi (60 mbar to 10 bar)

Figure 2. Transfer Function Limits

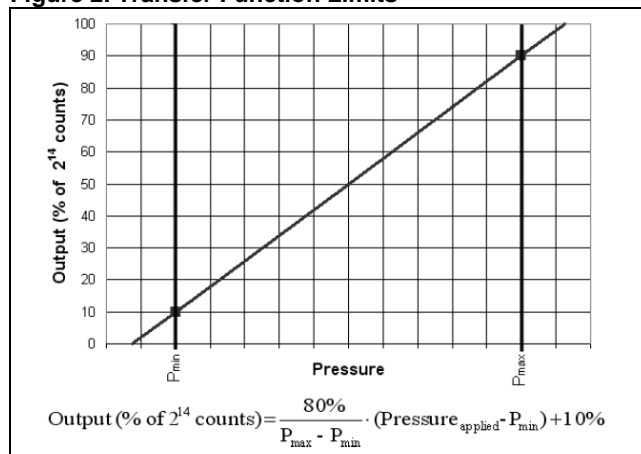



Figure 3. Completed Catalog Listing Example



HSCSANN100PGSA3
SIP package, AN pressure port, no diagnostics, 100 psi gage, SPI output, 10% to 90% calibration at 3.3 Vdc.

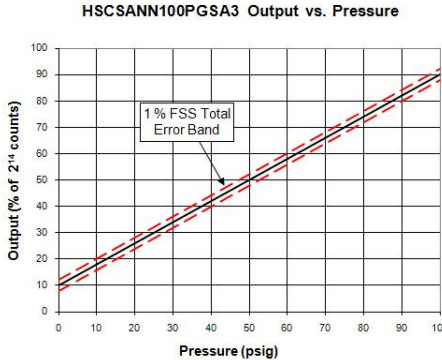

Table 5. Pressure Types

Pressure Type	Description
Absolute	Output is proportional to the difference between applied pressure and a built-in reference to vacuum. P _{min.} is set at absolute zero pressure (full vacuum).
Differential	Output is proportional to the difference between the pressures applied to each port. (Port 1 – Port 2) 50% point of transfer function set at Port 1 = Port 2.
Gage	Output is proportional to the difference between applied pressure and atmospheric (ambient) pressure. P _{min.} is set at atmospheric pressure.

Table 6. Sensor Output at Significant Percentages

% Output	Digital Counts (decimal)	Digital Counts (hex)
0	0	0x0000
10	1638	0x0666
50	8192	0x2000
90	14746	0x399A
100	16383	0x3FFF

Table 7. Pressure Range Specifications for 1 psi to 150 psi

Order Code	Pressure Range		Over-pressure ¹⁵	Burst Pressure ¹⁶	Common Mode Pressure ¹⁷	Long-term Stability (1000 hr, 25 °C [77 °F])
	P _{min.}	P _{max.}				
Absolute						
015PA	0 psi	15 psi	30 psi	60 psi	NA	±0.25% FSS
030PA	0 psi	30 psi	60 psi	120 psi	NA	±0.25% FSS
060PA	0 psi	60 psi	120 psi	240 psi	NA	±0.25% FSS
100PA	0 psi	100 psi	250 psi	250 psi	NA	±0.25% FSS
150PA	0 psi	150 psi	250 psi	250 psi	NA	±0.25% FSS
Differential						
001PD	-1 psi	1 psi	10 psi	10 psi	150 psi	±0.35% FSS
005PD	-5 psi	5 psi	30 psi	40 psi	150 psi	±0.35% FSS
015PD	-15 psi	15 psi	30 psi	60 psi	150 psi	±0.25% FSS
030PD	-30 psi	30 psi	60 psi	120 psi	150 psi	±0.25% FSS
060PD	-60 psi	60 psi	120 psi	240 psi	250 psi	±0.25% FSS
Gage						
001PG	0 psi	1 psi	10 psi	10 psi	150 psi	±0.35% FSS
005PG	0 psi	5 psi	30 psi	40 psi	150 psi	±0.35% FSS
015PG	0 psi	15 psi	30 psi	60 psi	150 psi	±0.25% FSS
030PG	0 psi	30 psi	60 psi	120 psi	150 psi	±0.25% FSS
060PG	0 psi	60 psi	120 psi	240 psi	250 psi	±0.25% FSS
100PG	0 psi	100 psi	250 psi	250 psi	250 psi	±0.25% FSS
150PG	0 psi	150 psi	250 psi	250 psi	250 psi	±0.25% FSS

TruStability™ Silicon Pressure Sensors: HSC Series—High Accuracy

Table 8. Pressure Range Specifications for 60 mbar to 10 bar

Order Code	Pressure Range		Over-pressure ¹⁵	Burst Pressure ¹⁶	Common Mode Pressure ¹⁷	Long-term Stability (1000 hr, 25 °C [77 °F])
	P _{min}	P _{max}				
Absolute						
001BA	0 bar	1 bar	2 bar	4 bar	NA	±0.25% FSS
1.6BA	0 bar	1.6 bar	4 bar	8 bar	NA	±0.25% FSS
2.5BA	0 bar	2.5 bar	6 bar	8 bar	NA	±0.25% FSS
004BA	0 bar	4 bar	8 bar	16 bar	NA	±0.25% FSS
006BA	0 bar	6 bar	17 bar	17 bar	NA	±0.25% FSS
010BA	0 bar	10 bar	17 bar	17 bar	NA	±0.25% FSS
Differential						
060MD	-60 mbar	60 mbar	500 mbar	700 mbar	10 bar	±0.35% FSS
100MD	-100 mbar	100 mbar	500 mbar	700 mbar	10 bar	±0.35% FSS
160MD	-160 mbar	160 mbar	500 mbar	700 mbar	10 bar	±0.35% FSS
250MD	-250 mbar	250 mbar	1.4 bar	2.5 bar	10 bar	±0.35% FSS
400MD	-400 mbar	400 mbar	1.4 bar	2.5 bar	10 bar	±0.35% FSS
600MD	-600 mbar	600 mbar	2 bar	4 bar	10 bar	±0.25% FSS
001BD	-1 bar	1 bar	2 bar	4 bar	10 bar	±0.25% FSS
1.6BD	-1.6 bar	1.6 bar	4 bar	8 bar	10 bar	±0.25% FSS
2.5BD	-2.5 bar	2.5 bar	6 bar	8 bar	10 bar	±0.25% FSS
004BD	-4 bar	4 bar	8 bar	16 bar	10 bar	±0.25% FSS
Gage						
060MG	0 mbar	60 mbar	500 mbar	700 mbar	3.5 bar	±0.35% FSS
100MG	0 mbar	100 mbar	500 mbar	700 mbar	10 bar	±0.35% FSS
160MG	0 mbar	160 mbar	500 mbar	700 mbar	10 bar	±0.35% FSS
250MG	0 mbar	250 mbar	1.4 bar	2.5 bar	10 bar	±0.35% FSS
400MG	0 mbar	400 mbar	1.4 bar	2.5 bar	10 bar	±0.35% FSS
600MG	0 mbar	600 mbar	2 bar	4 bar	10 bar	±0.35% FSS
001BG	0 bar	1 bar	2 bar	4 bar	10 bar	±0.25% FSS
1.6BG	0 bar	1.6 bar	4 bar	8 bar	10 bar	±0.25% FSS
2.5BG	0 bar	2.5 bar	6 bar	8 bar	10 bar	±0.25% FSS
004BG	0 bar	4 bar	8 bar	16 bar	16 bar	±0.25% FSS
006BG	0 bar	6 bar	17 bar	17 bar	17 bar	±0.25% FSS
010BG	0 bar	10 bar	17 bar	17 bar	17 bar	±0.25% FSS

Notes:

- Overpressure: The maximum pressure which may safely be applied to the product for it to remain in specification once pressure is returned to the operating pressure range. Exposure to higher pressures may cause permanent damage to the product. Unless otherwise specified this applies to all available pressure ports at any temperature with the operating temperature range.
- Burst pressure: The maximum pressure that may be applied to any port of the product without causing escape of pressure media. Product should not be expected to function after exposure to any pressure beyond the burst pressure.
- Common mode pressure: The maximum pressure that can be applied simultaneously to both ports of a differential pressure sensor without causing changes in specified performance.

Table 9. Pinout for SMT and DIP Packages

Output Type	Pin 1	Pin 2	Pin 3	Pin 4	Pin 5	Pin 6	Pin 7	Pin 8
I ² C	GND	V _{supply}	SDA	SCL	NC	NC	NC	NC
SPI	GND	V _{supply}	MISO	SCLK	SS	NC	NC	NC

Table 10. Pinout for SIP Package

Output Type	Pin 1	Pin 2	Pin 3	Pin 4
I ² C	GND	V _{supply}	SDA	SCL

±1% Total Error Band, Digital Output, 1 psi to 150 psi (60 mbar to 10 bar)

Figure 4. DIP Pressure Port Dimensional Drawings (For reference only: mm [in])

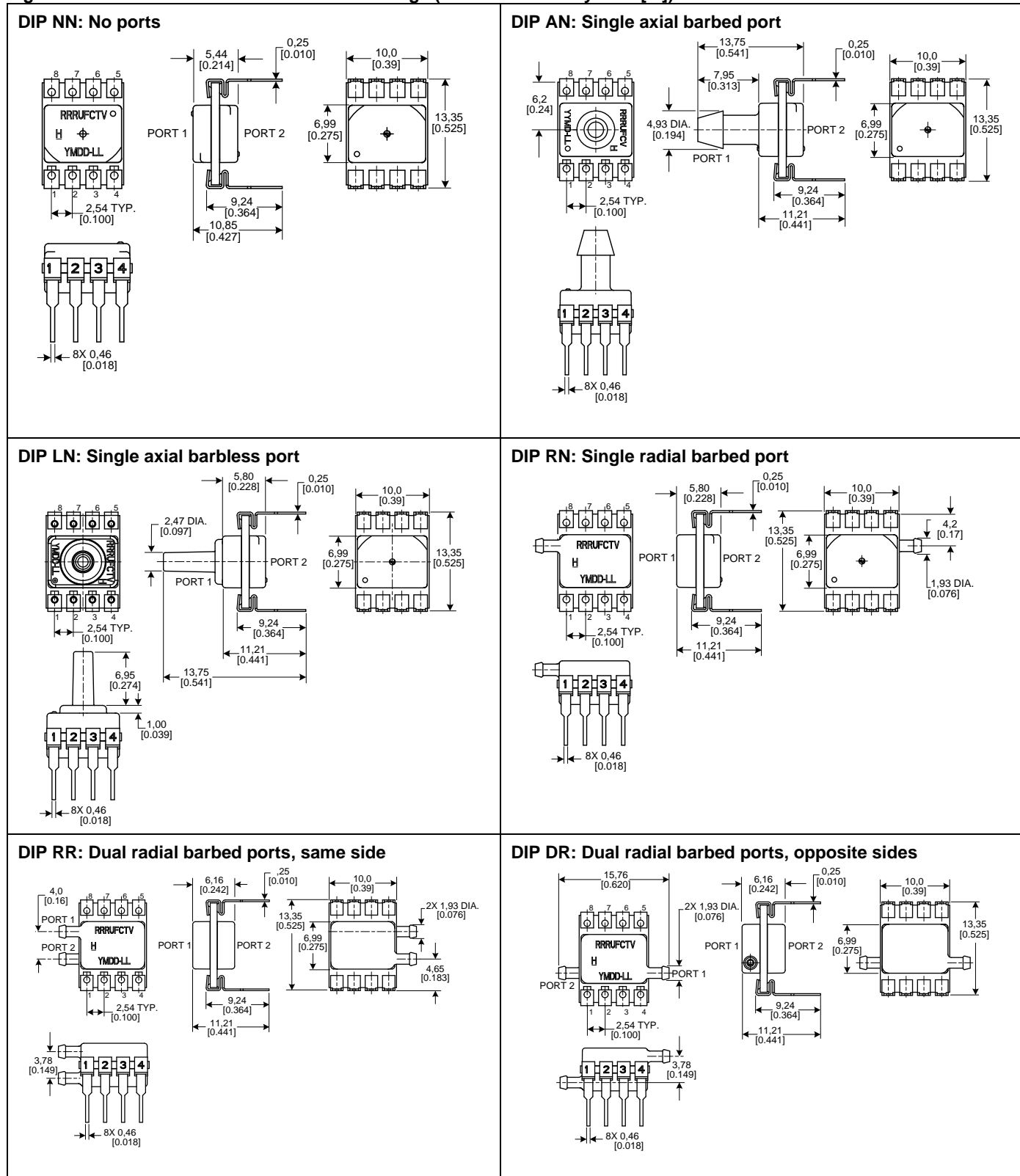

TruStability™ Silicon Pressure Sensors: HSC Series—High Accuracy

Figure 5. SMT Pressure Port Dimensional Drawings (For reference only: mm [in])

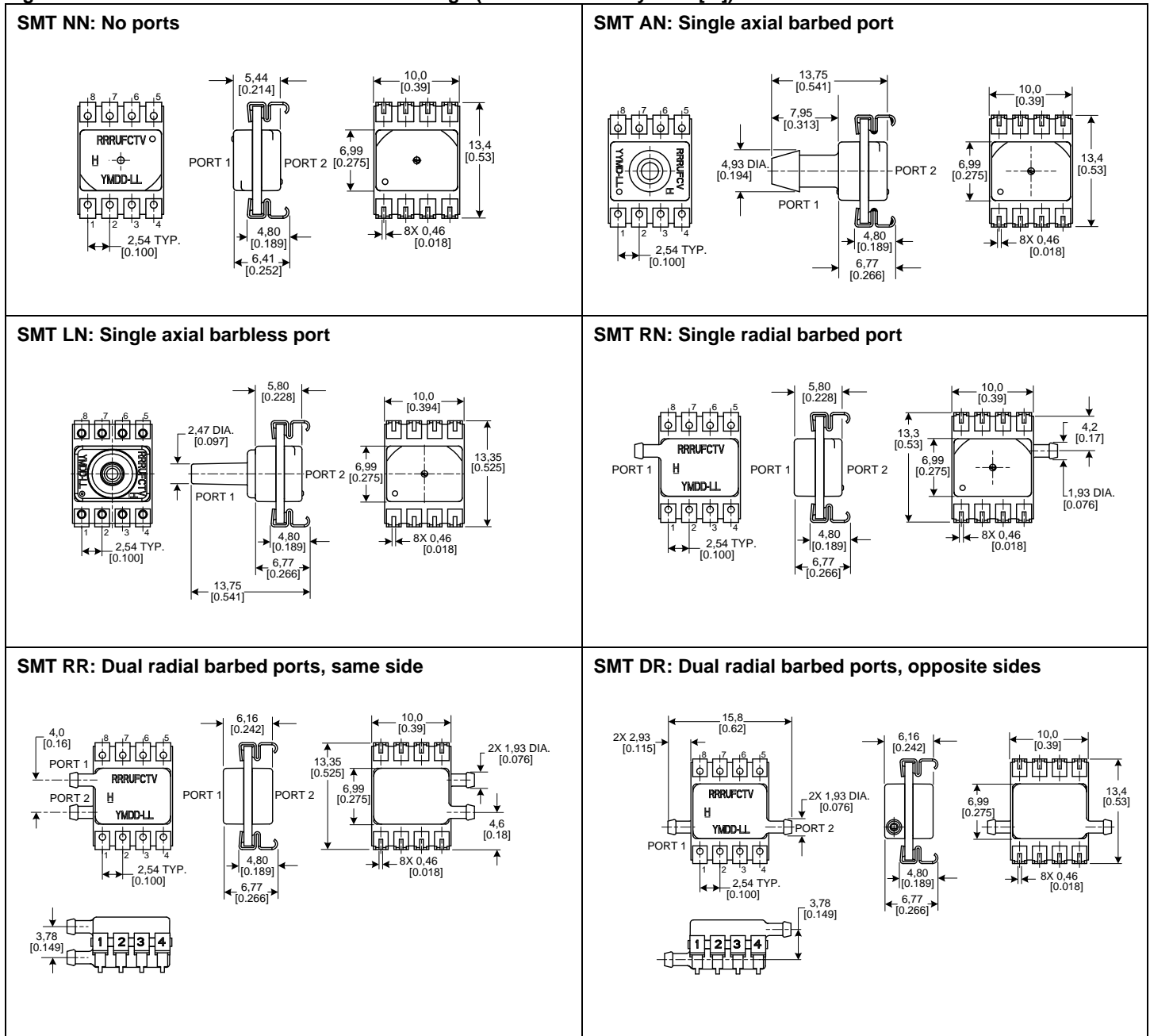

±1% Total Error Band, Digital Output, 1 psi to 150 psi (60 mbar to 10 bar)

Figure 6. SIP Package Dimensional Drawings (For reference only: mm [in])

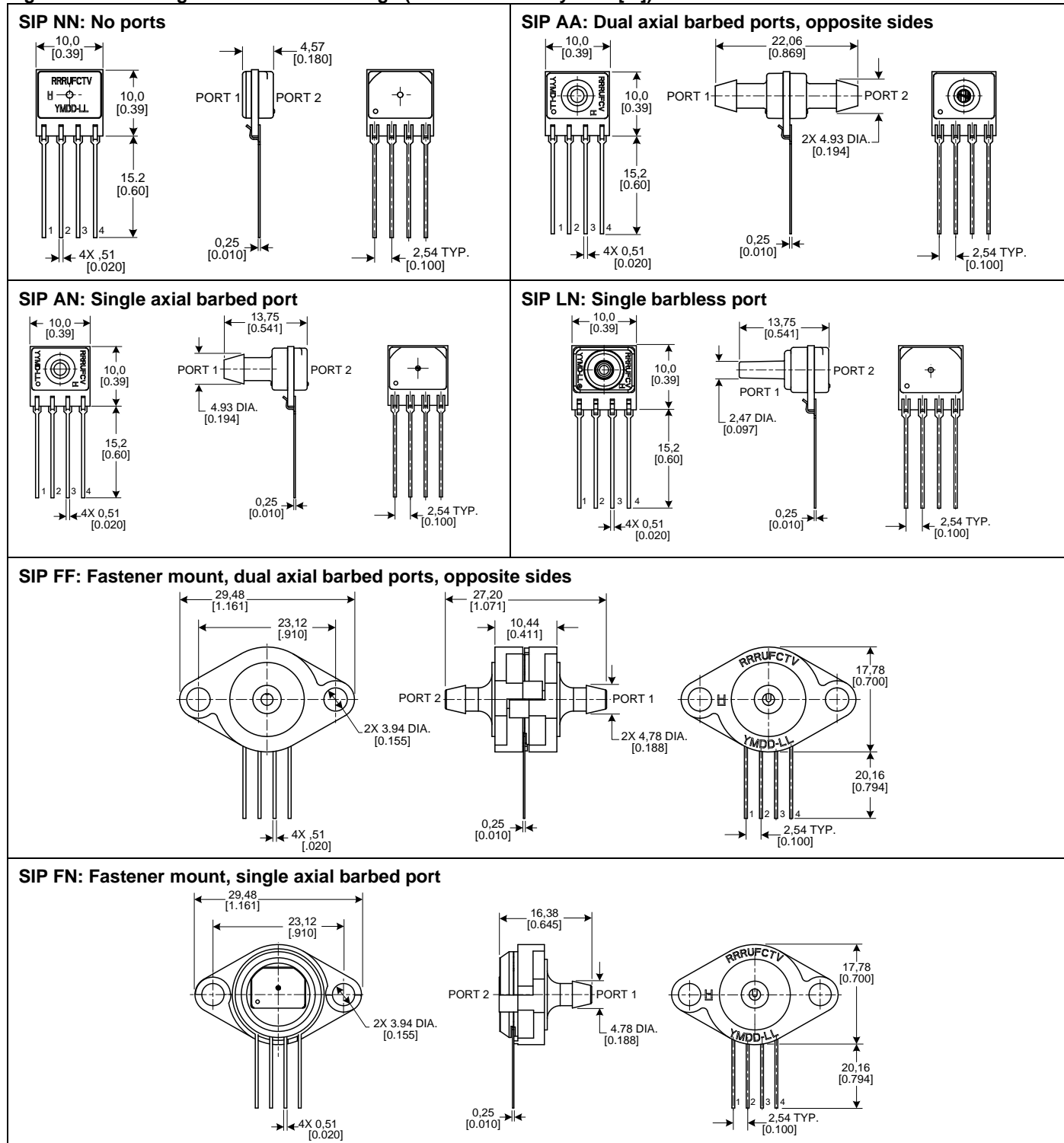

TruStability™ Silicon Pressure Sensors: HSC Series—High Accuracy

Figure 6. SIP Package Dimensional Drawings (continued)

SIP GN: Ribbed fastener mount, single axial barbed port



SIP NB: Fastener mount, dual axial ports, same side

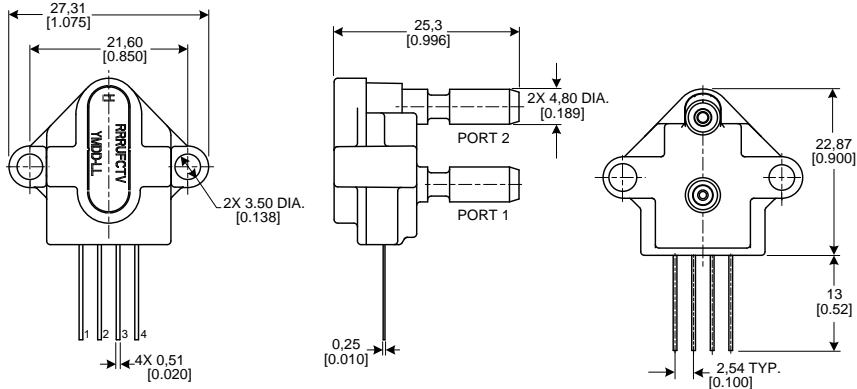

SIP RN: Single radial barbed port

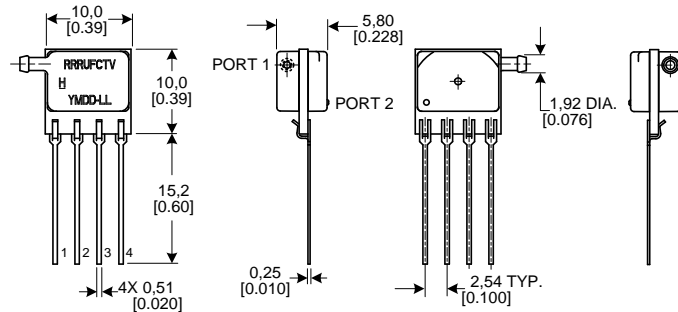

SIP RR: Dual radial barbed ports, same side

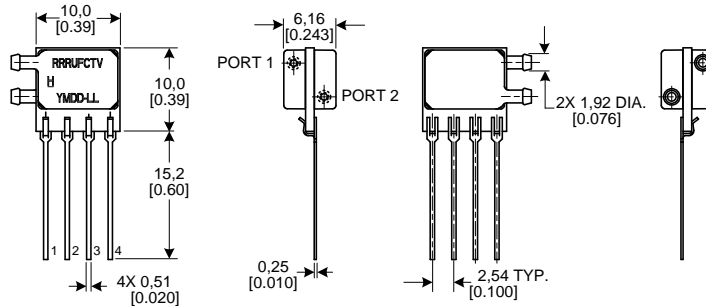

±1% Total Error Band, Digital Output, 1 psi to 150 psi (60 mbar to 10 bar)

Figure 6. SIP Package Dimensional Drawings (continued)

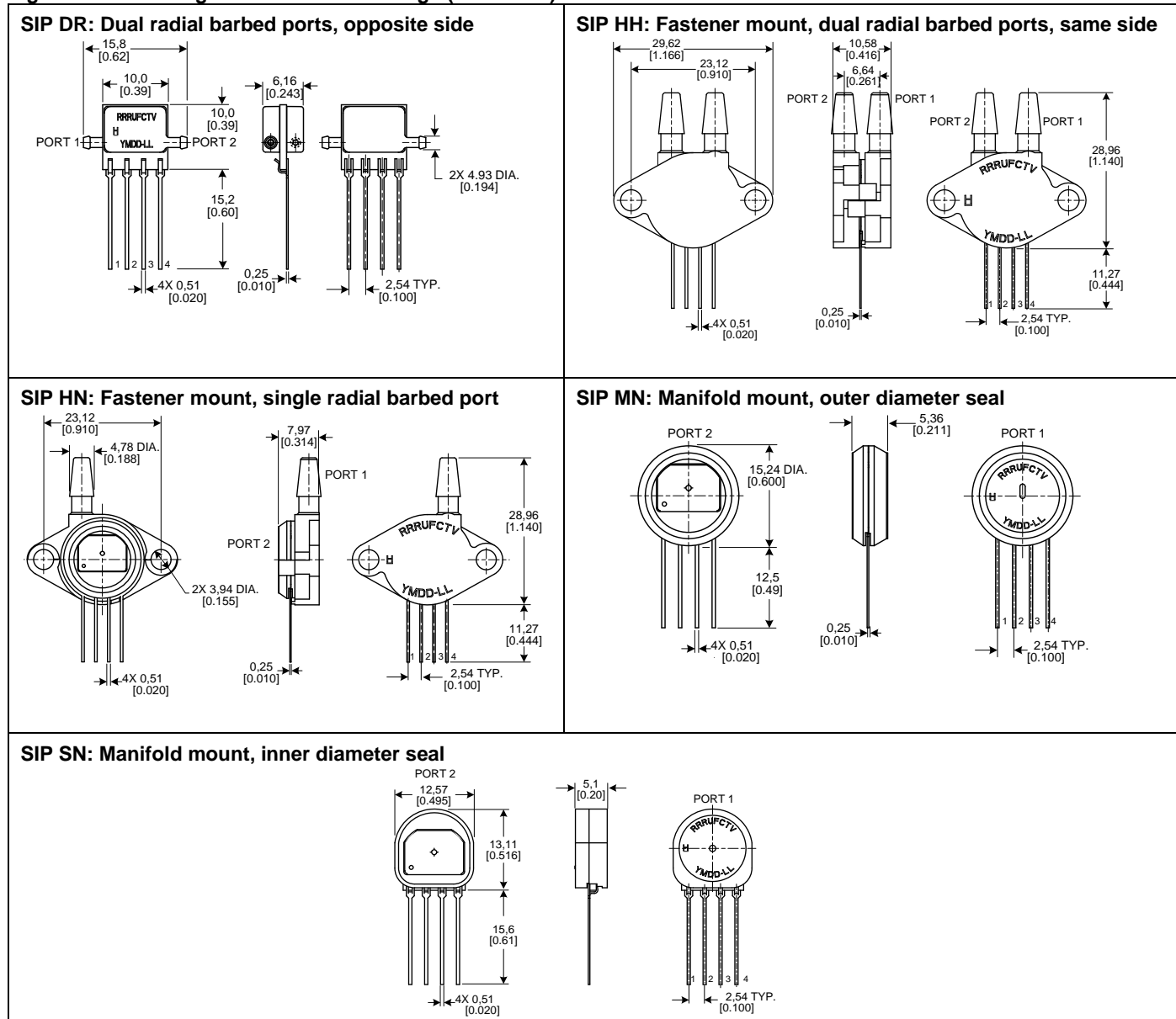

WARNING

PERSONAL INJURY

DO NOT USE these products as safety or emergency stop devices or in any other application where failure of the product could result in personal injury.

Failure to comply with these instructions could result in death or serious injury.

WARRANTY/REMEDY

Honeywell warrants goods of its manufacture as being free of defective materials and faulty workmanship. Honeywell's standard product warranty applies unless agreed to otherwise by Honeywell in writing; please refer to your order acknowledgement or consult your local sales office for specific warranty details. If warranted goods are returned to Honeywell during the period of coverage, Honeywell will repair or replace, at its option, without charge those items it finds defective. **The foregoing is buyer's sole remedy and is in lieu of all other warranties, expressed or implied, including those of merchantability and fitness for a particular purpose. In no event shall Honeywell be liable for consequential, special, or indirect damages.**

While we provide application assistance personally, through our literature and the Honeywell web site, it is up to the customer to determine the suitability of the product in the application.

Specifications may change without notice. The information we supply is believed to be accurate and reliable as of this printing. However, we assume no responsibility for its use.

WARNING

MISUSE OF DOCUMENTATION

- The information presented in this product sheet is for reference only. DO NOT USE this document as a product installation guide.
- Complete installation, operation, and maintenance information is provided in the instructions supplied with each product.

Failure to comply with these instructions could result in death or serious injury.

SALES AND SERVICE

Honeywell serves its customers through a worldwide network of sales offices, representatives and distributors. For application assistance, current specifications, pricing or name of the nearest Authorized Distributor, contact your local sales office or:

E-mail: info.sc@honeywell.com

Internet: www.honeywell.com/sensing

Phone and Fax:

Asia Pacific	+65 6355-2828; +65 6445-3033 Fax
Europe	+44 (0) 1698 481481; +44 (0) 1698 481676 Fax
Latin America	+1-305-805-8188; +1-305-883-8257 Fax
USA/Canada	+1-800-537-6945; +1-815-235-6847 +1-815-235-6545 Fax

Sensing and Control
Honeywell
1985 Douglas Drive North
Golden Valley, MN 55422
www.honeywell.com

008214-1-EN IL50 GLO Printed in USA
July 2010
© 2010 Honeywell International Inc.

Honeywell