

General Specifications

Electrical Capacity (Resistive Load)

Power Level (silver): 6A @ 125V AC & 3A @ 250V AC

4A @ 30V DC for On-None-On & On-None-Off; 3A @ 30V DC for all other circuits

Logic Level (gold): 0.4VA maximum @ 28V AC/DC maximum (Applicable Range 0.1mA ~ 0.1A @ 20mV ~ 28V)

Logic/Power Level (gold over silver): Combines silver & gold ratings

Note: Find additional explanation of dual rating & operating range in Supplement section.

Other Ratings

Contact Resistance: 10 milliohms maximum for silver; 20 milliohms maximum for gold

Insulation Resistance: 1,000 megohms minimum @ 500V DC

Dielectric Strength: 1,000V AC minimum between contacts for 1 minute minimum;
1,500V AC minimum between contacts and case for 1 minute minimum

Mechanical Life: 100,000 operations minimum; 50,000 operations minimum for flat, locking & splashproof devices

Electrical Life: 25,000 operations minimum for silver; 50,000 operations minimum for gold;

50,000 operations minimum for silver at 3A @ 125V AC

Angle of Throw: 25°

Materials & Finishes

Toggle: Brass with chrome plating

Frame: Stainless steel

Bushing: Brass with nickel plating

Support Bracket: Brass with tin plating

Case: Diallyl phthalate resin (UL94V-0)

Movable Contactor: Phosphor bronze with silver or gold plating

Movable Contacts: Silver alloy (code W); copper with gold plating (code G); or silver alloy with gold plating (code A)

Stationary Contacts: Silver with silver plating (code W); copper or brass with gold plating (code G);
or silver with gold plating (code A)

Terminals: Copper or brass with silver plating; or copper or brass with gold plating

Environmental Data

Operating Temp Range: -30°C through +85°C (-22°F through +185°F)

Humidity: 90 ~ 95% humidity for 96 hours @ 40°C (104°F)

Vibration: 10 ~ 55Hz with peak-to-peak amplitude of 1.5mm traversing the frequency range & returning in 1 minute; 3 right angled directions for 2 hours

Shock: 50G (490m/s²) acceleration (tested in 6 right angled directions, with 5 shocks in each direction)

Sealing: Splashproof bushing options B3, D3, D8, L3, & L8, which have o-rings inside & outside the bushing, meet IP67 of IEC60529 Standards.

Installation

Mounting Torque: 3.0Nm (26.55 lb•in) double nut for large bushing;
1.5Nm (13 lb•in) double nut & 0.7Nm (6 lb•in) single nut for all other bushings

Processing

Soldering: Wave Soldering (PC version) for Gold: See Profile A in Supplement section.

Manual Soldering for Gold: See Profile A in Supplement section.

Wave Soldering (PC version) for Silver: See Profile B in Supplement section.

Manual Soldering for Silver: See Profile B in Supplement section.

Note: Lever must be in OFF (center) position while soldering.

Cleaning: These devices are not process sealed. Hand clean locally using alcohol based solution.

Standards & Certifications

Flammability Standards: UL94V-0 for case

UL: File No. E44145

All models recognized at 6A @ 125V AC, 3A @ 250V AC or 0.4VA maximum @ 28V DC maximum.

Add "/U" to end of part number to order UL mark on switch.

Add "/CUL" to end of part number to order cULus mark on switch.

CSA: File No. 023535_0_000

All models recognized at 6A @ 125V AC or 3A @ 250V AC or 0.4VA maximum @ 28V maximum.

Add "/C" to end of part number to order CSA mark on switch.

Distinctive Characteristics

Antirotation design, standard on noncylindrical levers, mates toggle and bushing; bottom of toggle has two flattened sides which fit into a complementary opening inside bushing.

Antijamming design protects contacts from damage due to excessive downward force on actuator.

High torque bushing construction prevents rotation or separation from frame during installation.

High insulating barriers increase isolation of circuits in multipole devices and provide added protection to contact points.

Molded diallyl phthalate case has a UL flammability rating of 94V-0.

Epoxy sealed terminals prevent entry of solder flux and other contaminants.

Prominent external insulating barriers increase insulation resistance and dielectric strength.

Interlocked actuator block, lever, and interior guide prevent switch failure due to biased lever movement.

Clinching of frame to case well above base and terminals provides 1,500V dielectric strength.

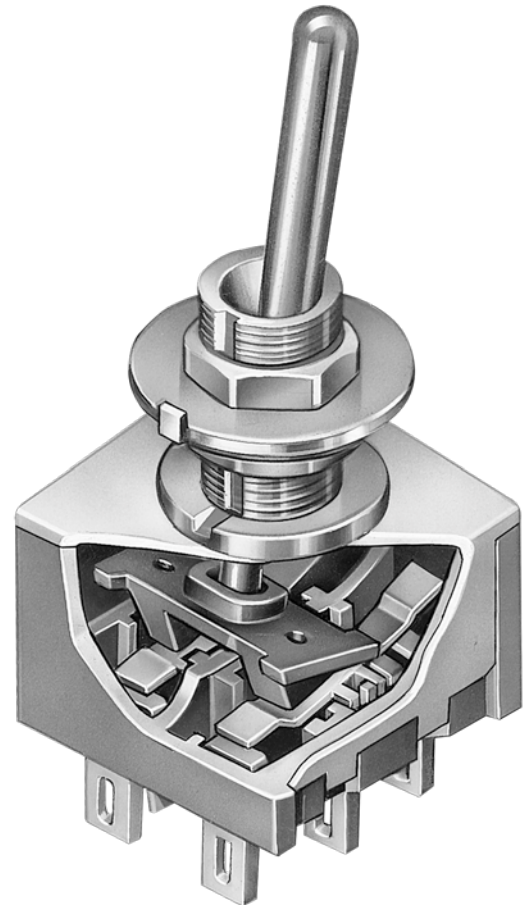

Actual Size

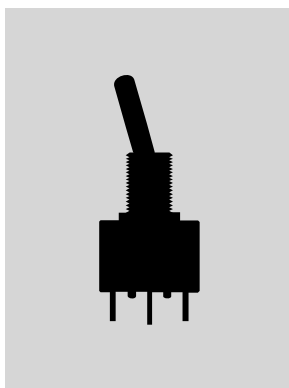

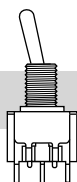
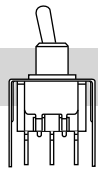
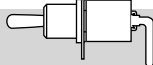
	Bushing Mount	Page A48
	Bracket PC Mount	Page A60
	Angle PC Mount	Page A66

A Toggles

Rockers

Pushbuttons

Illuminated PB

Programmable

Keylocks

Rotaries

Slides

Tactiles

Tilt

Touch

Indicators

Accessories

Supplement

Series M

Angle PC Mount Miniature Toggles

TYPICAL SWITCH

ORDERING EXAMPLE

M20 **1** **2** **S2** **A2**

Poles	
1	SPDT
2	DPDT SP3T
3	3PDT
*4	4PDT DP3T

*4-pole available on vertical models only.

Small Toggles	
S	.413" (10.5mm) Bat
S2	.200" (5.08mm) Bat
S3	.256" (6.5mm) Bat
E	.450" (11.4mm) Flatted
E2	.256" (6.5mm) Flatted

Toggle dimensions are based on use with a .350" (8.9mm) bushing; add .070" (1.78mm) to toggle length when combining with a .280" (7.1mm) bushing.

Small Bushings	
A2	.280" (7.1mm) Smooth with Keyway
S2	.350" (8.9mm) Smooth with Keyway
A1	.280" (7.1mm) Threaded with Keyway
S1	.350" (8.9mm) Threaded with Keyway

Locking Lever	
L	.201" (5.1mm) Dia. Locking Lever

Bushing For Locking Levers	
L2	Smooth with Keyway for Lever Lock

Circuits		
2	ON	NONE ON
3	ON	OFF ON
5	ON	NONE (ON)
8	(ON)	OFF (ON)
9	ON	OFF (ON)
*4	ON	ON ON
*6	(ON)	ON (ON)
*7	ON	ON (ON)

() = Momentary
*3-ON circuits available with double and four pole bases only

Standard Toggle, Bushing, & Terminal Combinations:
S2A2G30, S2A2G40, S2G30, S2G40, LL2G30, & LL2G40

G **40**

Contact Materials & Ratings	
W	Silver; Rated 6A @ 125V AC & 3A @ 250V AC
G	Gold; Rated 0.4VA max @ 28V AC/DC max
A	Gold over Silver; Rated 6A @ 125V AC & 0.4VA max @ 28V AC/DC max

Optional Caps	
B	For S Bat Toggle
C	Conical Cap for S Bat Toggle

Cap Colors	
A	Black
B	White
C	Red
E	Yellow
F	Green
G	Blue

Cap for Locking Lever	
No Code	Nickel Plated Supplied with Switch
A	Black
C	Red
G	Blue





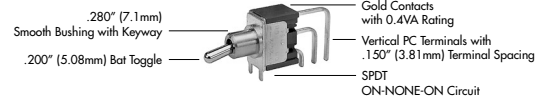

Terminals	
30	.150" (3.81mm) Right Angle PCB (1-3 Pole)
32	Right Angle PCB (1 Pole & 0.4VA Rating Only)
40	.150" (3.81mm) Vertical PC (1-4 Pole)
45	.100" (2.54mm) Vertical PC (1-4 Pole)

DESCRIPTION FOR TYPICAL ORDERING EXAMPLE
M2012S2A2G40



IMPORTANT:
 Switches are supplied without UL, cULus & CSA marking unless specified. Specific models & ratings noted on General Specifications page.

POLES & CIRCUITS

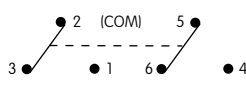
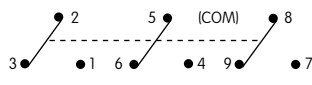
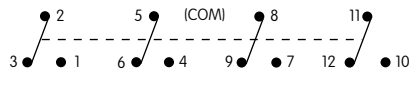
Pole	Model	Toggle Position () = Momentary			Connected Terminals			Throw & Schematics
		Down 	Center 	Up 	Down 	Center 	Up 	
SP	*M2012 *M2013 *M2015 *M2018 M2019	ON ON ON (ON) ON	NONE OFF NONE OFF OFF	ON ON (ON) (ON) (ON)	2-3	OPEN	2-1	Note: Terminal numbers are not actually on the switch. * Reverse circuits available for vertical mount SP & DP upon request. 
DP	*M2022 *M2023 *M2025 *M2028 M2029	ON ON ON (ON) ON	NONE OFF NONE OFF OFF	ON ON (ON) (ON) (ON)	2-3 5-6	OPEN	2-1 5-4	
3P	M2032 M2033 M2035 M2038 M2039	ON ON ON (ON) ON	NONE OFF NONE OFF OFF	ON ON (ON) (ON) (ON)	2-3 5-6 8-9	OPEN	2-1 5-4 8-7	
4P	M2042 M2043 M2045 M2048 M2049	ON ON ON (ON) ON	NONE OFF NONE OFF OFF	ON ON (ON) (ON) (ON)	2-3 5-6 8-9 11-12	OPEN	2-1 5-4 8-7 11-10	

For 3 Throw (3-On)

Connected Terminals & Schematics

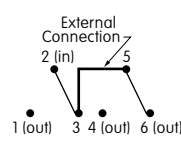
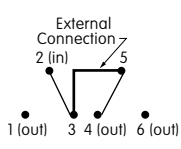
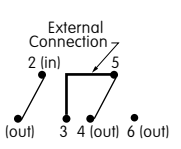
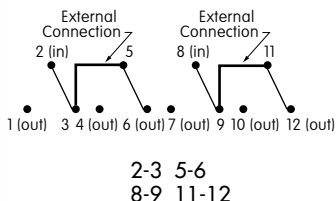
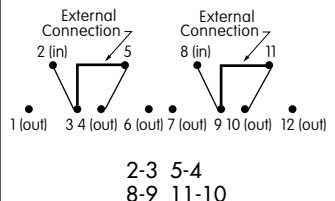
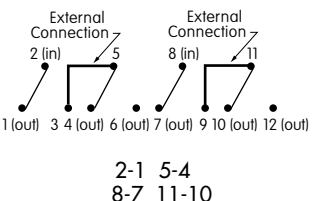
Pole	Model	Down	Center	Up	Down	Center	Up
SP	M2024 M2026 M2027	ON (ON) ON	ON ON ON	ON (ON) (ON)	 2-3 5-6	 2-3 5-4	 2-1 5-4
DP	M2044 M2046 M2047	ON (ON) ON	ON ON ON	ON (ON) (ON)	 2-3 5-6 8-9 11-12	 2-3 5-4 8-9 11-10	 2-1 5-4 8-7 11-10

The SP3T model utilizes a double pole base.

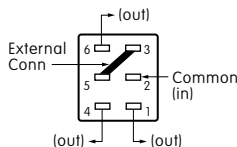

External connection must be made during field installation.

The DP3T model utilizes a four pole base.

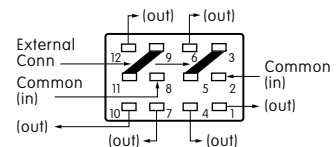

External connection must be made during field installation.

SMALL TOGGLES

Important:

Toggle length changes based on bushing selected. All illustrations are shown with .350" (8.9mm) long bushing. When using a .280" (7.1mm) long bushing, toggle length increases .070" (1.78mm).

S .413" (10.5mm) Bat

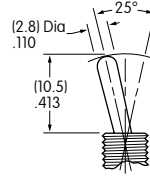

S2 .200" (5.08mm) Bat

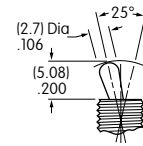

S3 .256" (6.5mm) Bat

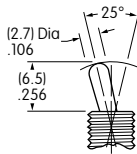

E .450" (11.4mm) Flatted

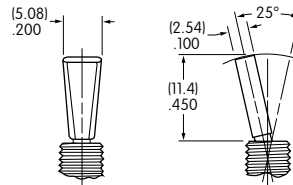

E2 .256" (6.5mm) Flatted

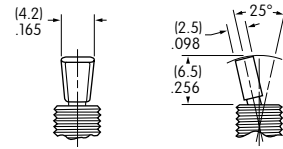

Standard Material & Finish: Brass with Bright Chrome
Contact factory for optional finishes.

SMALL BUSHINGS

A2 .280" (7.1mm) Smooth with Keyway

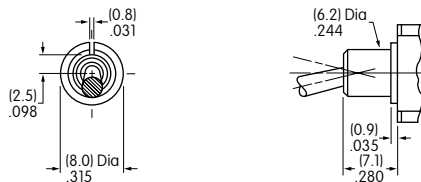

S2 .350" (8.9mm) Smooth with Keyway

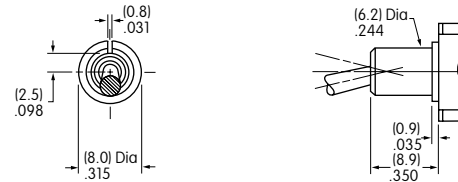

When using this bushing, toggle length is increased by .070" (1.78mm).

A1 .280" (7.1mm) Threaded with Keyway

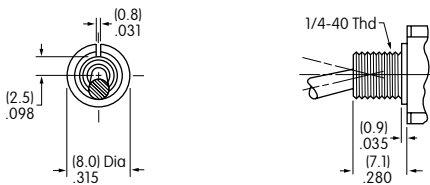

S1 .350" (8.9mm) Threaded with Keyway

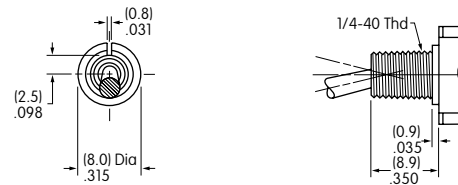

When using this bushing, toggle length is increased by .070" (1.78mm). Maximum Panel Thickness with Standard Hardware: .031" (0.8mm)

Maximum Panel Thickness with Standard Hardware: .102" (2.6mm)

Panel Cutouts

For A2, S2, A1 or S1 Bushing with Keyway

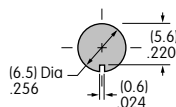

For A1 or S1 Bushing with Locking Ring

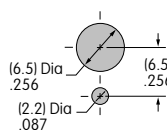

Standard Hardware:

- 2 Hex Nuts (AT513H)
- 1 Lockwasher (AT509)
- 1 Locking Ring (AT507H)

For dimensions, see Accessories & Hardware section.

LOCKING LEVER & BUSHING

LL2 Smooth with Keyway

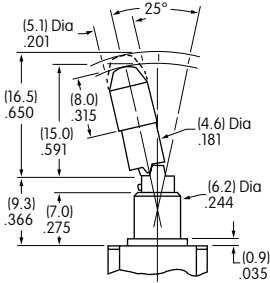
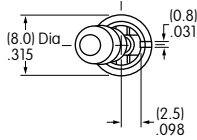

2 positions lock



1 position locks



2 positions lock



3 positions lock

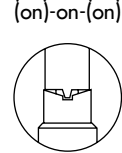

1 position locks

No Code

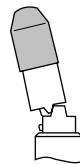

Cap for Locking Lever
Supplied with Cap AT427
Material & Finish:
 Brass with Nickel Plating
Lever Material & Finish:
 Brass with Chrome Plating

Color Codes for Optional Anodized Aluminum Caps



Black



Red



Blue

CONTACT MATERIALS & RATINGS



Silver over Silver

Power Level

6A @ 125V AC & 3A @ 250V AC



Gold over Brass or Copper

Logic Level

0.4VA maximum @ 28V AC/DC maximum

Note: See Supplement section to find complete explanation of operating range.



Gold over Silver

Power Level or Logic Level

6A @ 125V AC or 0.4VA maximum @ 28V AC/DC maximum

Note: This dual rated option is suitable when two or more identical switches are used in logic and in power circuits within the same application. See Supplement section to find complete explanation of dual rating and operating range.

TERMINALS

30 .150" (3.81 mm) Right Angle PC (1-3 Pole)

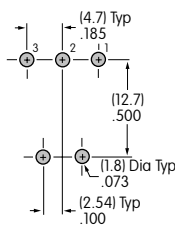
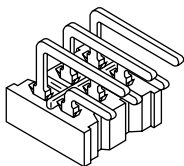

Single Pole

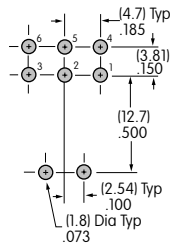

Double Pole

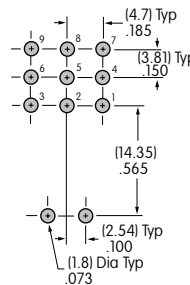

Three Pole

32 Right Angle PCB with Reverse Circuit (1 Pole & 0.4VA Rating Only)

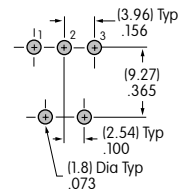
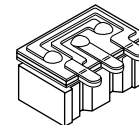

Terminal dimensions are shown on the Typical Switch Dimensions pages which follow.

TERMINALS (Continued)

A
Toggles

40 .150" (3.81mm)
Vertical PC (1-4 Pole)

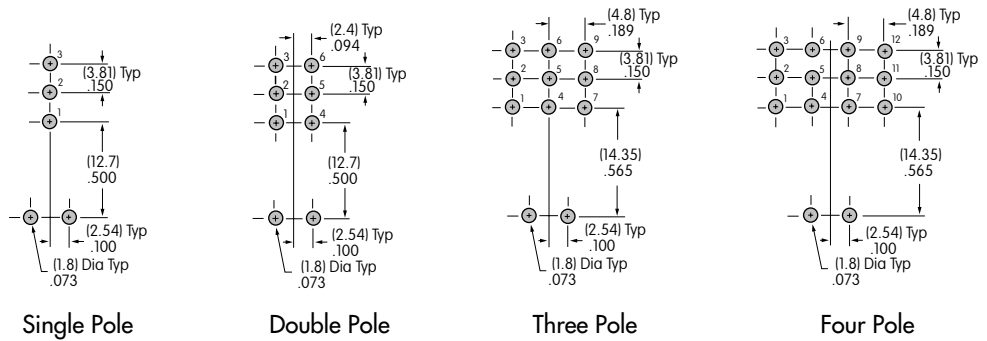
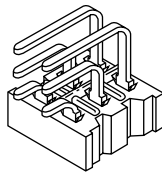

45 .100" (2.54mm)
Vertical PC (1-4 Pole)

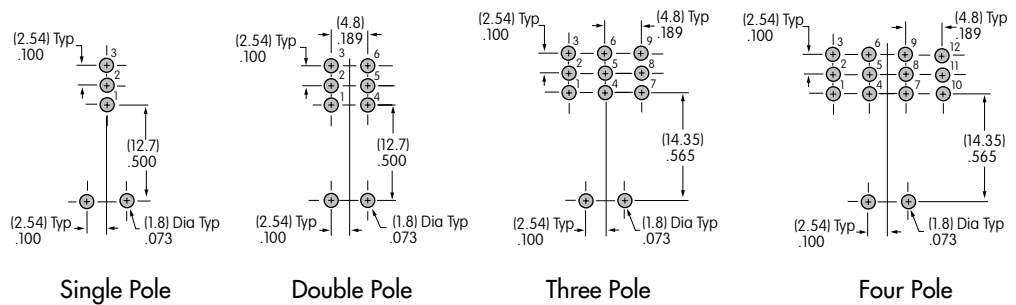
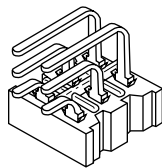

Terminal dimensions are shown on the Typical Switch Dimensions pages which follow.

OPTIONAL CAPS & CAP COLORS

B AT415
for S Bat Toggle

Material:
Polyethylene

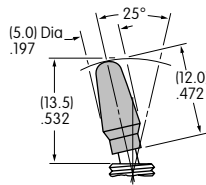

C AT444
Conical Cap for S Bat Toggle

Material:
Polyethylene

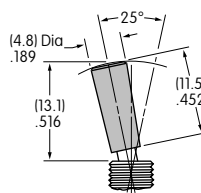

Colors Available

- | | |
|----------------|-----------------|
| A Black | E Yellow |
| B White | F Green |
| C Red | G Blue |

STANDARD HARDWARE

AT513H for Inch
AT513M for Metric
Hex Nut (2 per switch)
Brass/Nickel

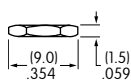
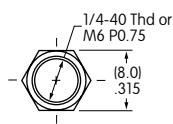

AT507H for Inch
AT507M for Metric
Locking Ring (1 per switch)
Steel with Zinc/Chromate

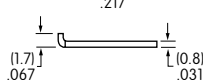
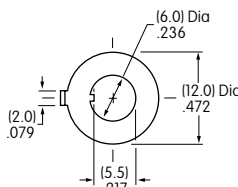

AT509
Lockwasher (1 per switch, none
with splashproof)
Steel with Zinc/Chromate

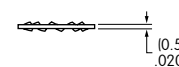
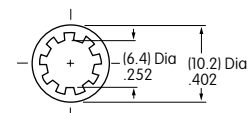

Rockers

Pushbuttons

Illuminated PB

Programmable

Keylocks

Rotaries

Slides

Tactiles

Tilt

Touch

Indicators

Accessories

Supplement

TYPICAL SWITCH DIMENSIONS

.150" (3.81mm) Right Angle PC

Single Pole

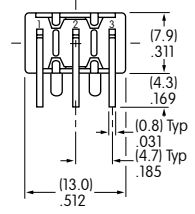
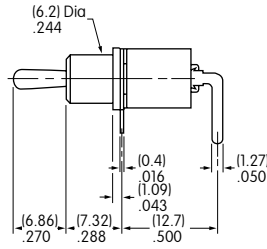
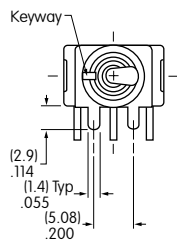

M2012S2A2G30

.150" (3.81mm) Right Angle PC

Double Pole

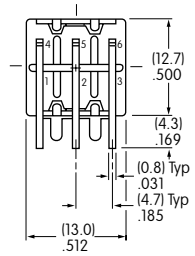
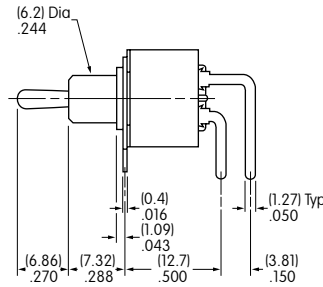
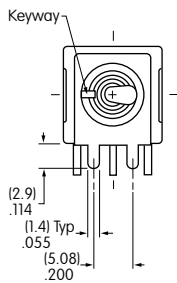

M2022S2A2G30

.150" (3.81mm) Right Angle PC

Three Pole

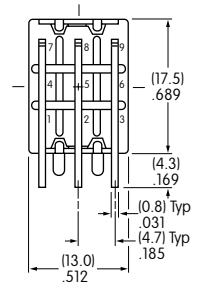
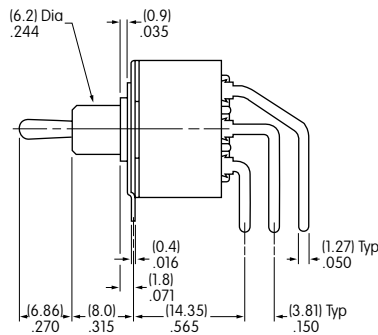
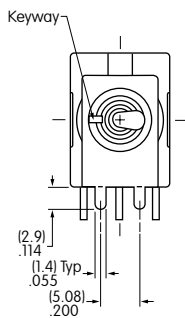
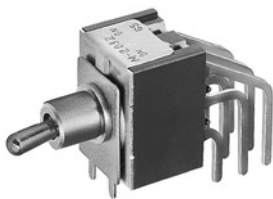

M2032S2A2G30

Right Angle PCB

Single Pole • Reverse Circuit

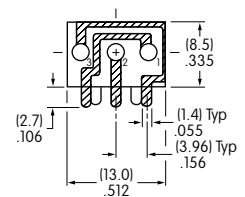
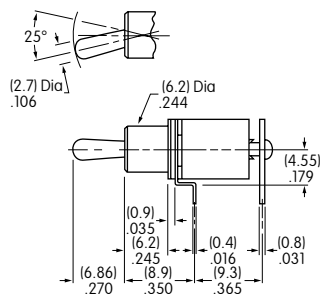
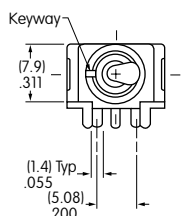

M2012S2A2G32

TYPICAL SWITCH DIMENSIONS

Single Pole

.150" (3.81mm) Vertical PC

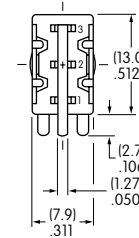
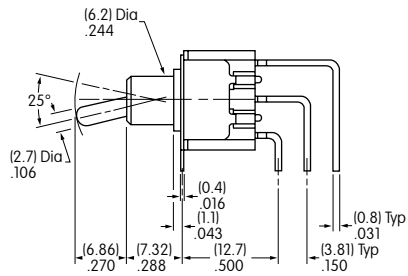
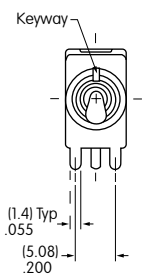

M2012S2A2G40

Double Pole

.150" (3.81mm) Vertical PC

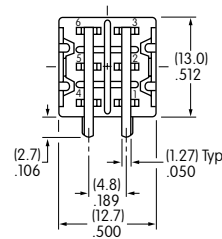
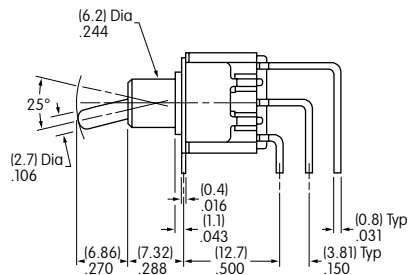
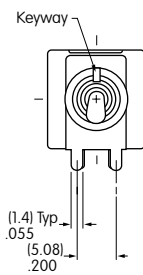

M2022S2A2G40

Three Pole

.150" (3.81mm) Vertical PC

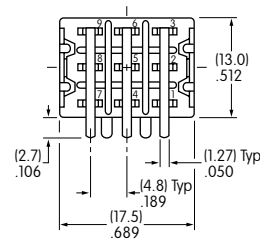
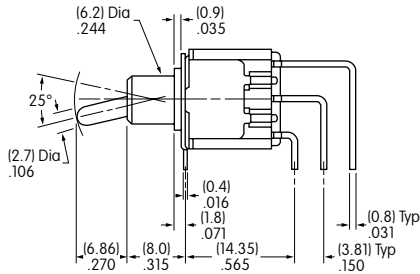
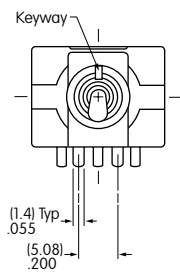

M2032S2A2G40

Four Pole

.150" (3.81mm) Vertical PC

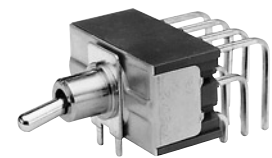
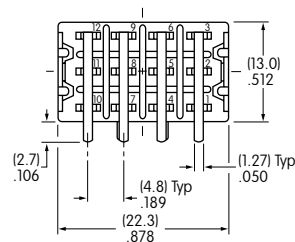
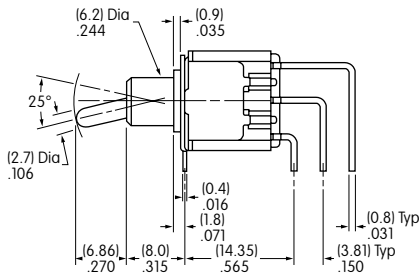
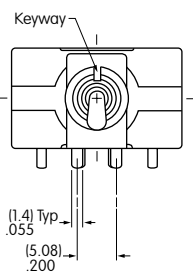

M2042S2A2G40

A Toggles

Rockers

Pushbuttons

Illuminated PB

Programmable

Keylocks

Rotaries

Slides

Tactiles

Tilt

Touch

Indicators

Accessories

Supplement

TYPICAL SWITCH DIMENSIONS

.100" (2.54mm) Vertical PC

Single Pole

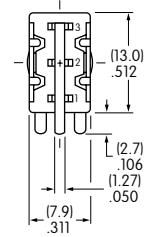
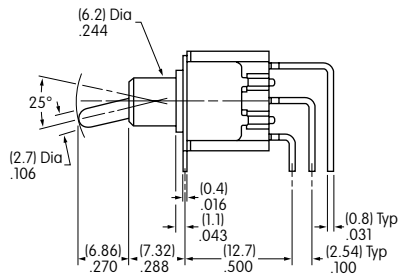
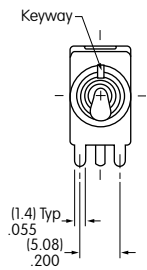

M2012S2A2G45

.100" (2.54mm) Vertical PC

Double Pole

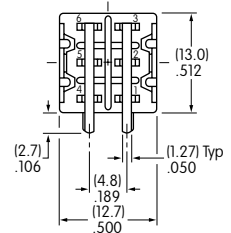
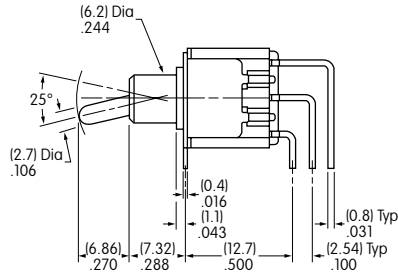
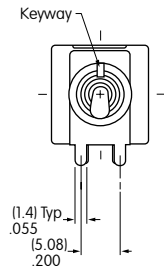
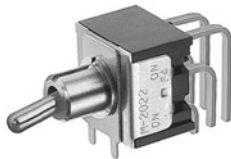

M2022S2A2G45

.100" (2.54mm) Vertical PC

Three Pole

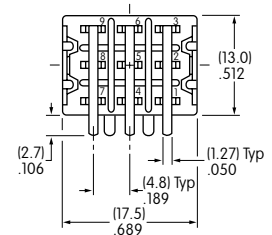
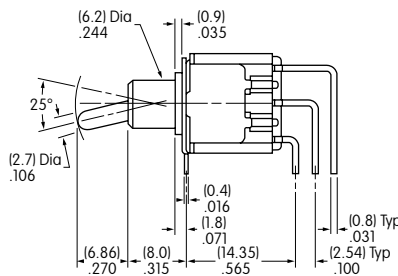
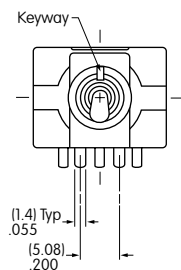

M2032S2A2G45

.100" (2.54mm) Vertical PC

Four Pole

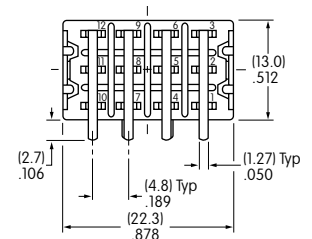
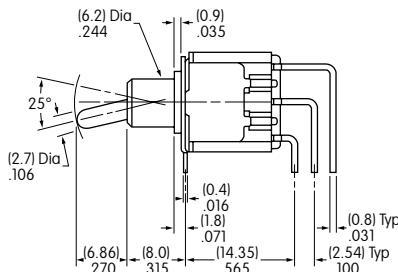
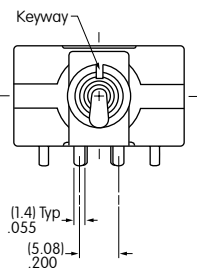

M2042S2A2G45